

# Gas Metal Arc Welding Used on Mainline 80 ksi Pipeline in Canada

*Welding developments meet the demands from the natural gas industry for large diameter, higher strength pipe*

BY D. V. DORLING, A. LOYER, A. N. RUSSELL AND T. S. THOMPSON

The transportation of increasing volumes of natural gas can be achieved by a combination of larger pipe diameters and higher operating pressures requiring heavier wall thicknesses. Since the cost of the pipeline in terms of materials and construction is largely limited to the diameter and wall thickness of the pipe, one approach to limit these costs has been, and continues to be, the use of higher strength pipe materials.

Pipe to NPS 42 CSA-Z245.1 Grade 414 (60,000 psi yield) has been used by NOVA for the construction of large-diameter pipelines since 1968. Grade 483 (70,000 psi yield) pipe became available from Canadian mills in 1971, resulting in a 14% reduction in wall thickness and weight. Grade 550 (80,000 psi) will bring a further reduction of 12.5% over Grade 483. As well as the lower cost of the pipe itself, additional savings are achievable through reduced transportation charges and lower construction costs due to shorter welding and radiographic inspection times.

In the fall of 1989, it was decided to use Grade 550 pipe to construct the Empress East Crossover — Fig. 1. This project consists of two short sections of pipeline running between the foothills mainline system and an ethane stripping plant. The high operating pressure of the system, combined with future flow requirements, resulted in a diameter and wall thickness combination which could justify the use of a higher grade material — Table 1.

Due to its short length, the project could be designed, procured and built completely on the basis of Grade 550 material. The project would offer an opportunity to evaluate the performance of the pipe supplier and detect any problems in coating, field bending or field welding of this grade of pipe.

## Selection of Pipe Supplier

NOVA has been involved in discussions with various pipe manufacturers since 1987, and, in early 1989, pipe suppliers were invited by NOVA to supply samples of pipe considered by them to be able to meet Grade 550 requirements in order to "prequalify" them. Pipe body tests were carried out in accordance with CSA-Z245.1 and, as can be seen from Table 2, pipe from only three suppliers met the yield strength requirements of Grade 550.

*D. V. DORLING, A. LOYER and A. N. RUSSELL are with the Alberta Gas Transmission Division, Nova Corporation of Alberta, Calgary, Alberta, Canada. T. S. THOMPSON is with CRC-Evans Automatic Welding, Houston, Tex.*

Welds were produced in the pipe materials meeting Grade 550 requirements, following procedures adopted by The Welding Institute in work for the Pipeline Research Committee of the American Gas Association (Ref. 1), with cellulosic shielded metal arc welding electrodes. E55010 electrodes were used for the root with E62010 for the remaining passes. The welds were tested in accordance with CSA-Z184 and all were satisfactory.

Material specification data sheets were prepared for the pipe required for the Empress East project based on NOVA proprietary line pipe specification P-1, which is, in turn, based on CSA Standard CAN3-Z245.1 (itself similar to the API 5LX Standard). The NOVA specification contains additional restrictions on steel chemistry, carbon equivalent and dimension control, all designed to facilitate field welding. In addition, field welding using a cellulosic manual shielded metal arc process is always required and, consequently, the two prequalified pipe suppliers were required to provide proof of weldability with this process, in terms of freedom from hydrogen cracking, by submitting their products to a modified Welding Institute of Canada (WIC) restraint cracking test (Ref. 2).

Bids were solicited from the suppliers considered to have been capable of supplying Grade 550 material meeting all of NOVA's mechanical property and field weldability requirements. After review of the bids, the supply contract was awarded and the supplier was required to provide pipe samples of the proposed chemistry and rolling practice to further evaluate the welding procedures in preparation for construction.

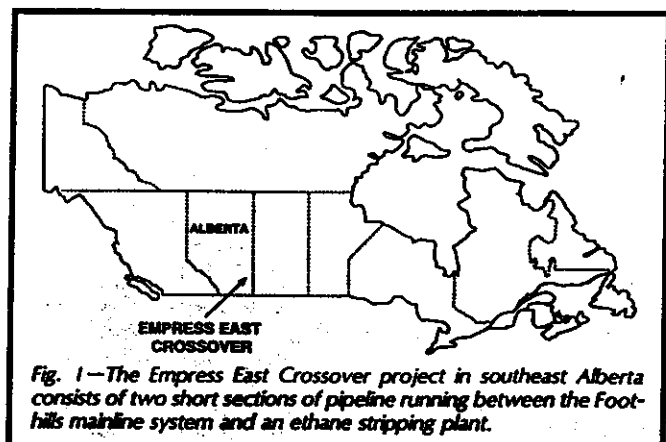

Fig. 1—The Empress East Crossover project in southeast Alberta consists of two short sections of pipeline running between the Foothills mainline system and an ethane stripping plant.

**Table 1—Empress East Crossover—Design Details**

Design Pressure	8700 kPa
Diameter	NPS 42
Design Factor	0.8 for line pipe 0.5 for plant pipe
Length	2.0 km of line pipe 0.5 km of plant pipe
Wall Thickness (Gr 550)	10.6 mm for line pipe 16.9 mm for plant pipe

## Selection of Field Welding Processes

### Shielded Metal Arc Welding

Even with all the developments in mechanized welding, manual welding using the shielded metal arc process with cellulosic electrodes remains an essential part of pipeline construction. Conditions such as tie-ins, road crossings, repairs and future maintenance require the flexibility of this process.

Work recently completed for the Pipeline Research Committee of the American Gas Association has studied the effect of overmatching and undermatching weld metal yield strengths on fracture behavior (Ref. 3). While the work concentrated on Grade 483 materials, it has some important implications for the welding of Grade 550 pipe.

The study shows that the difference between weld and pipe metal yield strengths is an important factor in protecting any pre-existing weld metal defect from severe plastic strains. Essentially, if the weld metal overmatches, then gross-section yielding is likely to occur in the pipe. If the weld undermatches, then gross-section yielding in the pipe will not occur, straining of the weld will occur, and higher levels of toughness will be required to prevent fracture initiation from a pre-existing defect. The use of cellulosic procedures with E55010/E62010 consumables is unlikely to achieve overmatching yield strengths. Results from the cellulosic E55010/E62010 procedure test on the selected supplier's prequalification Grade 550 pipe (Table 3) show that the CSA cross-weld tensile test (reinforcement in place) yield strength was 532–573 MPa (77–83 ksi). The same test with the reinforcement removed gave a yield strength of 516–522 MPa (75–76 ksi), with failures in the weld region. The pipe body tensile tests gave a yield strength of 618–649 MPa (90–94 ksi).

Although failure occurs in the pipe in standard CSA tests, the beneficial effect of the weld reinforcement is negated in the presence of a weld metal discontinuity. Even if an appropriate level of toughness can be achieved in these circumstances, it will be difficult to guarantee in the field.

Another important consideration with Grade 550 materials is softening in the heat-affected zone. How is this influenced

**Table 3—Tensile Test Results for E55010/E62010 Weld**

Type of Tensile Test	Sample	Yield Strength, MPa	Ultimate Strength, MPa
Pipe Body	1	649	753
	2	618	752
Reinforcement on	1	532	672
	2	573	689
Reinforcement removed	1	516	646
	2	522	650

**Table 2—Tensile Test Results on Candidate Grade 550 Pipe Steels**

Manufacturer	Sample	Yield Strength, MPa	Ultimate Strength, MPa
1	1	620	748
	2	612	745
2	1	649	753
	2	618	752
3	1	534	704
	2	536	703
4	1	546	659
	2	536	655
5	1	571	702
	2	553	675
6	1	520	642
	2	511	636

by welding procedures and weld metal yield strengths? Hardness traverses (Fig. 2) show that for the OD region the weld metal does slightly undermatch, and that the HAZ shows considerable softening. In the ID region (most susceptible to discontinuities), considerable weld metal undermatching occurs and the HAZ shows increased softening. The effect of a narrow band of softening in the HAZ at the OD may be difficult to interpret because of the beneficial effect of the surrounding material. In the root, however, the region is no longer narrow because of the undermatching of the weld, and no beneficial effect of surrounding material can be expected.

Furthermore, all welds produced with these cellulosic SMAW procedures on the candidate pipe materials revealed a tendency to internal undercutting and porosity in the root, which was felt would be even more difficult to control under field conditions. An alternative is to use basic electrodes which can provide the necessary strength and toughness, but these, in their conventional uphill formulation, are not conducive to high-productivity mainline welding. Low-hydrogen downhill electrodes are available for pipeline applications, but, while overall weld completion times are comparable to those achieved with cellulosic electrodes, root bead completion times are considerably slower.

A compromise was suggested by the pipe supplier. It was decided to test a combination of cellulosic root bead and hot pass, using electrodes of Japanese manufacture, with fills and cap passes deposited using basic electrodes specially designed for high-productivity downhill welding, also by the same Japanese manufacturer. A NOVA pipeline welder assisted the electrode manufacturer to complete the desired test welds. A 4-mm (0.16-in.) diameter E48010-G electrode was selected for the root and hot pass. The benefit of this lower strength electrode is its reduced susceptibility to hydrogen-assisted cracking and its superior operating characteristics, giving freedom from internal undercut. The 4.5-mm (0.18-in.) diameter E62018-G selected for fill and cap passes was similarly easy to use. The modified tip of the electrode (hollow tip with arc-starting compound) facilitated a clean start with no porosity, unlike low-hydrogen downhill electrodes previously evaluated. The welds met the radiographic and mechanical test requirements of the CSA standard.

The results of the tensile tests with both reinforcement on and reinforcement removed are given in Table 4. Although those tests with reinforcement removed still failed in the weld, the yield strengths recorded easily exceeded 550 MPa (80 ksi) and were close to the yield strength of the pipe as measured in the pipe body tensile tests.

## Mechanized Gas Metal Arc Welding

The mechanized gas metal arc welding process has become the standard for the welding of major, large-diameter, cross-country pipelines in Canada. Normally, projects such as Empress East would not be considered for mechanized welding because the length of pipeline to be constructed will not support the high mobilization and minimum rental costs of the mechanized welding equipment. However, there were a number of factors to be taken into consideration for the welding of the Grade 550 pipe:

- This trial project should evaluate the suitability of welding processes and procedures considered for any future, long-distance pipeline project using Grade 550 material.
- Matching or overmatching yield strengths can be obtained from these welds with standard procedures.
- If some heat-affected zone softening does occur, generally the HAZ is narrow and the full benefit of the surrounding pipe and weld metal properties will be realized. The mechanized gas metal arc welding process is a low-hydrogen process with considerably lower risk of HAZ discontinuities.

The construction of 102 km (63 miles) of a 42-in. (107-cm) diameter pipeline on the Western Alberta System, to be completed just prior to the commencement of the Empress East Crossover, offered the opportunity to use mechanized welding for the Grade 550 pipe with the minimum of additional cost. Both projects were included in one contract and mechanized welding was specified.

### *Pulsed GMA welding was used for hot, fill and cap passes.*

For the welding of the Ipsco-manufactured, Grade 483 pipe for the Western Alberta Mainline Loop, the pulsed gas metal arc welding process was specified for the hot pass. In all other passes conventional, short-circuiting GMAW was specified. Since 1985, NOVA has actively pursued the application of the pulsed GMAW process to pipeline construction (Refs. 4, 5). Alberta Gas Transmission Division research programs led to the development of a methodology for the selection of pulsed welding parameters and process control logic for pipeline welding applications and the identification of suitable wire/shielding gas combinations for superior strength and toughness properties. In 1989, a cooperative program between NOVA and CRC-Evans was completed to merge NOVA-developed pulse/arc length control logic with the capabilities of the CRC-Evans controlled drop transfer pulsed power source and, with the NOVA-developed Ar-He-CO<sub>2</sub> shielding gas in combination with Thyssen C-Mn-Si-Ti wire, establish a field-ready, mechanized pulsed gas metal arc welding capability. Detailed welding procedures were developed and qualified with a complete field-ready pulsed GMAW system in both Grade 483 and Grade 550 pipe steels.

Table 4—Tensile Test Results for E48010/E62018 Weld

Type of Tensile Test	Sample	Yield Strength, MPa	Ultimate Strength, MPa
Reinforcement on	1	633	733
	2	643	739
	3	633	737
	4	642	736
Reinforcement removed	1	625	717
	2	610	714
	3	613	708
	4	607	719

Using this equipment and the experience gained from the cooperative program, the pulsed GMAW process was first applied to the welding of the hot pass on the 30-km (18.6-mile), NPS 24 North Lateral Loop in the fall of 1989. The process was successful in eliminating spatter and reducing significantly the number of incomplete joint penetration and incomplete fusion discontinuities, hence, its selection.

Subsequent to the NOVA/CRC-Evans program, a project was completed for the pipeline research committee of the American Gas Association by Microalloying International on the pulsed gas metal arc welding of API 5LX80 steels (Ref. 6). The NOVA/CRC-Evans procedures were used to weld X80 pipe materials from five different mills with excellent results. The pulsed GMAW process was able to consistently produce discontinuity-free welds in a range of X80 materials at a joining rate equivalent to that of conventional mechanized GMAW. The welds produced exhibited overmatching yield strength and crack tip opening displacement (CTOD) toughness properties exceeding 0.32 mm at -5°C (1.28 in. at 23°F).

For these reasons, it was decided to use the pulsed gas metal arc welding process for hot, fill and cap passes for the welding of the Grade 550 Empress East project. The susceptibility of the pulsed GMAW process to the effects of residual pipe magnetism precludes its use for the internal root pass; this is applied using standard, short circuiting GMAW.

## Qualification of Construction Welding Procedures

### Mainline Welding

A previously established procedure for large-diameter, cross-country pipeline construction, where mechanized welding is used, is to inspect the weld using mechanized ultrasonic

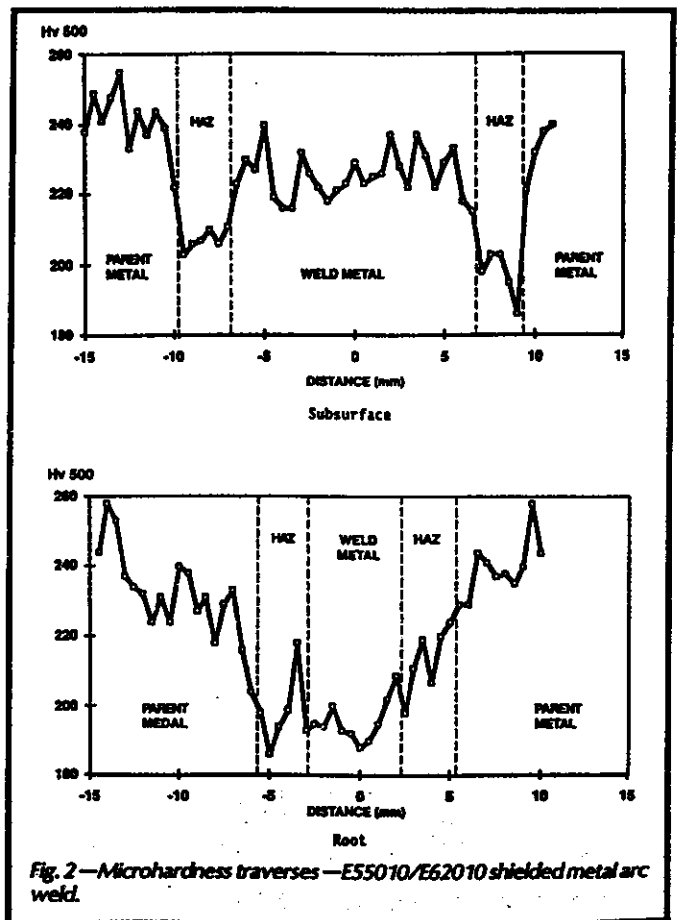

testing and employ an alternative weld acceptance standard based on engineering critical assessment (Ref. 7). In order to be qualified, welding procedures must meet the requirements of Clause 6.2.5 and Clause K3 of the CSA-Z184 standard. Clause K3 requires that cross-weld tensile tests be carried out with reinforcement removed and that the yield strength of the weldment be equal to or greater than the specified minimum yield strength of the pipe material. Charpy V-notch tests are required to be carried out in accordance with the requirements of ASTM Standard E23 and CTOD tests are required to be conducted in accordance with the requirements of British Standard BS 5762. Tighter restrictions apply on some of the essential welding variables.

The 42-in.-diameter, 10.6-mm and 16.9-mm (0.42- and 0.68-in. wall thickness (WT)) project pipe was shipped to CRC-Evans in Houston to complete the welds for procedure qualification. "Set-in" welds, trial welds to confirm the number of passes for each wall thickness and the precise welding conditions for each individual pass, were first conducted using the previously developed procedures (Ref. 6) as a starting point.

*All tensile tests fractured outside of the welds.*

Two deviations from these existing procedures were required to accommodate project specific conditions. The first deviation was the use of the standard 75Ar-25CO<sub>2</sub> shielding gas for the root pass instead of 82.5Ar-12.5CO<sub>2</sub>-5He. The reason for this was to minimize equipment resetting and welder training when the contractor moved from the Grade 483 Western Alberta Mainline Loop to the Grade 550 Empress East project.

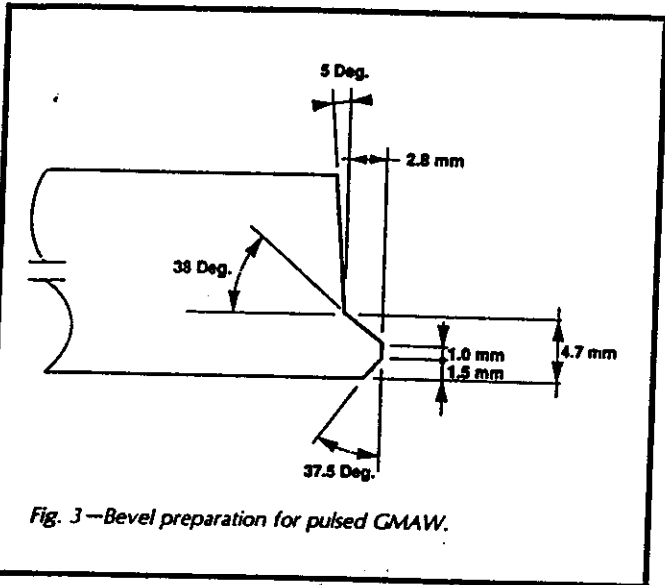

Fig. 3—Bevel preparation for pulsed GMAW.

Table 5—Pulsed GMA Welding Procedure

Consumables:	Root	0.9 mm diameter Thyssen K-Nova
	Hot, Fill & Cap	1.0 mm diameter Thyssen K-Nova
Shielding Gas (%):	Root	75Ar-25CO <sub>2</sub>
	Hot/Fills	82.5Ar-12.5CO <sub>2</sub> -5He
	Cap	87.5Ar-12.5 CO <sub>2</sub>
Welding Direction:	5G/Down	
Number of Welders:	Internal—Six Welding Heads	
	External—Two Welding Heads	

Electrical Parameters for 10.6 mm WT:

	Root (Internal) (Short Arc)	Hot (Pulsed)	Fill 1 (Pulsed)	Fill 2 (Pulsed)	Cap (Pulsed)
Arc Speed, mm/min	720-800	970-1070	360-400	300-460	300-460
Wire Speed, mm/min	9650	11430	7880	7880	7880
Gas Flow, cmh	1.7-2.1	1.1	1.1	1.1	1.4
CTWD, mm	9.0	12.5	12.5	12.5	12.5
Voltage, V	19-20	22-25	21-24	21-24	23-26
Amperage, A	190-210	220-260	150-180	150-180	140-180

Electrical Parameters for 16.9 mm WT:

	Root (Internal) (Short Arc)	Hot (Pulsed)	Fill 1 + 2 (Pulsed)	Fill 3 (Pulsed)	Cap (Pulsed)
Arc Speed, mm/min	720-800	970-1070	360-400	300-460	300-460
Wire Speed, mm/min	9650	11430	10920	10920	7880
Gas Flow, cmh	1.7-2.1	1.1	1.1	1.1	1.4
CTWD, mm	9.0	12.5	12.5	12.5	12.5
Voltage, V	19-20	22-25	22-25	22-25	23-26
Amperage, A	190-210	220-260	190-220	190-220	140-180
Pulse Parameters:		Pulse Width, ms		2.75	
		Peak Current, A		430	
		Background Current, A		45	

The second deviation was for the deposition of the cap pass. In the development work, the cap passes had been applied using the Model M200 industrial welding carriage. The system to be used on the Empress East project was the P100 pipeline "bug," which lacks the sidewall dwell capabilities of the M200. As a result, external undercut was encountered during procedure development. To overcome the problem, the shielding gas mixture for the cap pass was changed from the 82.5Ar-12.5CO<sub>2</sub>-5He to 87.5Ar-12.5CO<sub>2</sub>.

The 10.6-mm and 16.9-mm wall thickness welding procedures are shown in Table 5. A bevel geometry designed to minimize the number of fill passes on the heavy wall was used on both thicknesses and is shown on Fig. 3.

Five "consistency" welds were produced for each thickness and subjected to radiographic inspection according to Clause 6.2.9 of CSA-Z184. Two welds for each thickness were taken at random and subjected to a manual ultrasonic inspection using the probes and acceptance criteria designed for the mechanized ultrasonic inspection to be used on the project. The welds were then shipped back to Canada for destructive testing, according to Clause 6.2.5 and Clause K.3 of CSA-Z184.

The results of tensile tests with reinforcement on and reinforcement removed are given in Table 6. All tests fractured outside of the welds, indicating that the weld metal was overmatching.

Hardness traverses (Fig. 4) show, for both the OD and the ID regions, that the weld metal matches or overmatches, and that there is less softening of the heat-affected zone than with the conventional SMAW procedure.

### Manual SMAW Tie-in and Repair Welding

According to CSA-Z184, a tie-in welding procedure covering both wall thicknesses of Grade 550 pipe could be qualified by a single test weld on 16.9-mm-thick material. Although the grade of the material was the same, the chemistry and rolling practice were different for the two wall thicknesses and it was therefore decided to produce and qualify welding procedures for both. In addition, the pipeline was tied to valve assemblies using transition pieces made of 17.5-mm (0.7-in.) WT, Grade 483 pipe and the procedure for joining the Grade 550 to the Grade 483 also required qualification.

Repair welding procedures were qualified by producing and testing repairs of previously completed welds in two positions (first and third quadrant).

All welds were qualified by radiographic inspection according to Clause 6.2.9 and destructive testing to Clause 6.2.5 of CSA-Z184. In addition to these requirements, the following tests were conducted:

- Charpy V-notch tests at -5°C in the weld metal and HAZ.
- Microhardness traverses (Hv500).
- Metallographic examination.

The various combinations of manual welds qualified are summarized in Table 7.

A typical SMAW procedure is given in Table 8.

## Performance during Construction

### Mainline Welding

Normally, welders are required to complete and qualify for all passes. However, as Empress East was such a short project, each welder was qualified only for a specific pass of the procedure. The root and hot pass welders were already trained from having used the same process on the previous 100 km (62 miles) of the Grade 483 project and only minimal training was considered necessary for the fill and cap welders to make

Table 6—Tensile Test Results for Pulsed Gas Metal Arc Weld

Type of Tensile Test	Sample	Yield Strength, MPa	Ultimate Strength, MPa
Reinforcement on	1	594	708
	2	621	723
	3	615	702
	4	598	707
Reinforcement removed	1	619	699
	2	572	698

the transition from the short arc to the pulsed GMAW process. After having assembled all the equipment on the right-of-way, each welder completed his pass on five consecutive training/qualification welds. All welds were acceptable based on radiographic inspection and the welders were qualified to start production welding.

Production welding consisted of 98 welds in pipe of 10.6 mm and 28 welds in 16.9 mm wall thickness. Such a short project did not warrant a full spread of mechanized welding equipment capable of 100 welds per day. Only one welding station was utilized for each pass as opposed to the multiple fill and cap stations that would normally be provided. However, equipment handling and welding speeds for the pulsed GMAW process are similar to those with conventional, short arc GMAW and there is no reason to expect that the productivity will be any different. The pulsed welding equipment had already proven itself on two NOVA long-distance pipeline projects for the welding of the hot pass, in a variety of right-

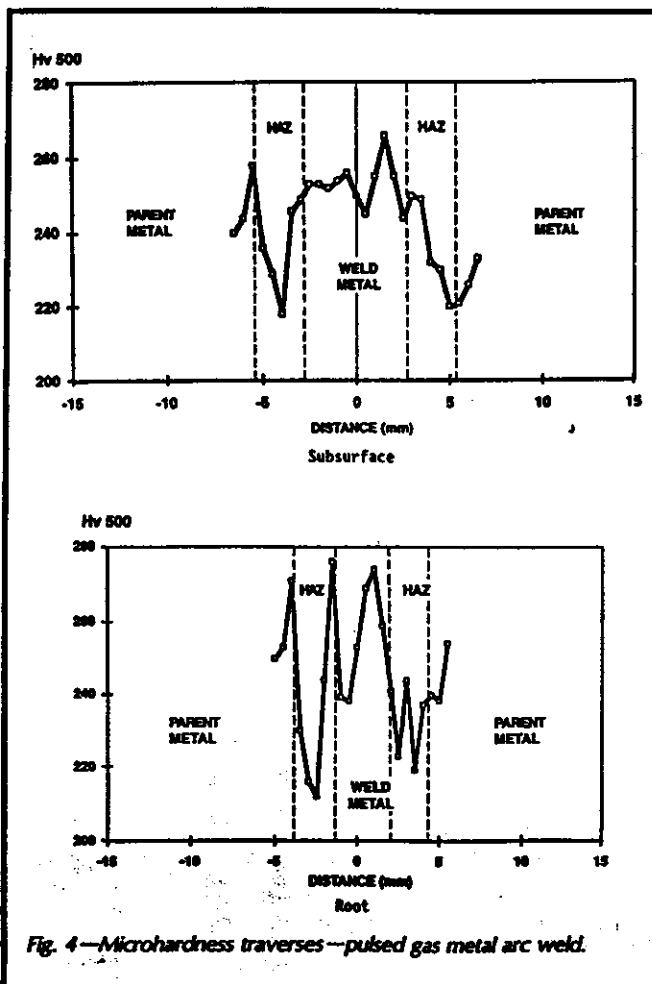

Fig. 4—Microhardness traverses—pulsed gas metal arc weld.

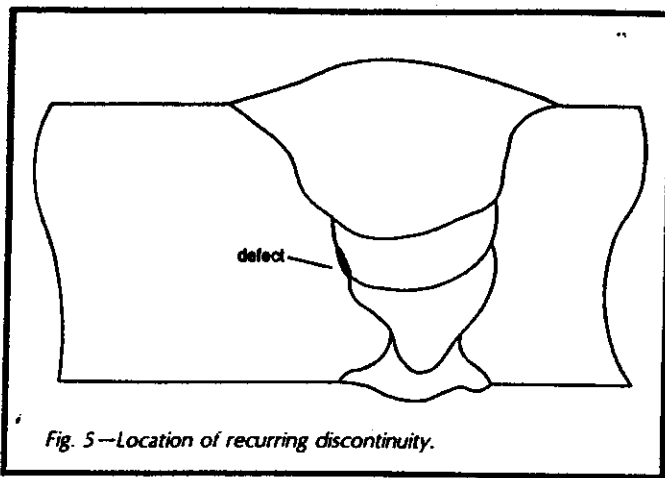

Fig. 5—Location of recurring discontinuity.

of-way and weather conditions, and the equipment continued to operate satisfactorily at Empress East.

Nearly 50% of the welds contained rejectable discontinuities detected by a combination of radiographic and ultrasonic inspection. Such a level of repairs is not unusual at the start of any project and many of the discontinuities were clearly equipment set-up problems or human errors, which normally disappear after a few days of construction. However, a recurring problem that immediately presented itself on commencing production welding was indications of incomplete sidewall fusion in the first fill pass, some of which were of rejectable length. The indications were limited to the vertical sections (3 and 9 o'clock positions) of the weld and predominantly on one side of the pipe (one welder). At first, the discontinuity was detected only by ultrasonic inspection and was confirmed by metallographic examination of a cross-section of a defective weld. The discontinuity was later detected both by radiography and ultrasonic inspection. The morphology and location of the discontinuity indicates that it is technique related. As can be seen from Fig. 5, good penetration into the hot pass had been achieved and the sidewall had been melted. However, slag had been allowed to run between the molten pool and the sidewall and the weld failed to fuse.

The fill-pass bugs are configured such that the torch trails the carriage, which is opposite to the hot pass and cap pass bugs where the torch is located at the front of the carriage. The conventional fill-pass bugs supply a "blanket" gas shield from a tube located in front of the arc, whereas, for the pulsed GMAW process, the welding head has been modified to supply a flow of gas concentric to the welding arc. As a result of the gas cup surrounding the contact tube and the limited contact tube-to-work distance required by the process, the welder has limited visibility of the weld pool and, for the vertical sections at least, he is viewing the pool from behind. The problem is compounded by the brightness of the pulsed arc, and by the fact that the welder is changing position from standing to lying on his back to complete the bottom portion of the weld. During the change, he cannot control steering or contact tube-to-work distance. For the second fill pass in the 10.6-mm WT pipe, the welder's ability to see the arc and weld

Table 7—Material Combinations Qualified for SMAW

Tie-in on 10.6 mm WT x Gr. 550
Tie-in on 16.9 mm WT x Gr. 550
Tie-in on 16.9 mm WT x Gr. 550 to 17.5 mm x Gr. 483
Repair on 10.6 mm WT x Gr 550 PGMA mainline welds
Repair on 16.9 mm WT x Gr 550 PGMA mainline welds
Repair on 16.9 mm WT x Gr 550 SMA tie-in welds

pool is improved and no problems were encountered. For the 16.9-mm WT pipe, visibility is still impaired, although to a lesser degree, for the second fill pass and, not surprisingly, the defect occurred in both first and second fill passes. A revised welding procedure with a small change in the bevel angle to improve the visibility was qualified and succeeded in reducing the incidence of the defect but did not eliminate it. With more training or with experience on a longer project, the welders will develop the necessary skills to compensate for these equipment limitations and this was evident by the way the number of repairs required were diminishing as the project progressed. The repair rate on the final day of mainline welding was 14%. Nevertheless, in order to consider applying pulsed GMAW to fill and cap passes on future projects, a relatively small development exercise will need to be conducted to confirm that, with equipment properly configured, the recurring discontinuity is eliminated.

### Manual Tie-in and Repair Welding

Four welders were assigned for manual tie-ins and repairs and received four days of training in the techniques to handle the different cellulosic and low-hydrogen downhill electrodes. The welders were using their own Lincoln 200-A welding machines, which proved unable to reliably supply the current necessary for the qualified welding procedure requiring 4.5-mm ( $\frac{3}{16}$ -in.) electrodes in the fill and cap passes. A revised procedure using 4.0-mm ( $\frac{5}{16}$ -in.) electrodes were qualified to deal with this limitation. At the end of training, each welder was qualified by successfully completing all passes on half of the circumference of a tie-in weld. For repair welding, the welders were required to complete repairs in two opposite quadrants of a weld.

The completion time for the tie-in welds was only slightly slower than a conventional tie-in of the same size, due to the extra care taken to achieve a good fitup. Twenty-six tie-ins were complete with eight requiring repair. Both the time and the incidence of discontinuities would be expected to decrease as the welders became more familiar with the new consumables.

A total of 70 repairs were completed with 14 rejectable, primarily due to porosity. Repair welding was considered to be slightly slower with the use of low-hydrogen downhill electrodes, again through lack of familiarity. Some of the repairs were performed internally using a special crawler and the 4.0-mm low-hydrogen downhill electrode. In such a confined space, it was found that a smaller electrode would be easier to handle.

### Summary and Conclusions

A 2.5-km-long pipeline has been successfully designed, procured and constructed in accordance with the requirements of CSA-Z 184 using NPS 42 CSA-Z245, 1 Grade 550 pipe.

Current large diameter, cross-country pipeline construction

Table 8—SMAW Procedure for Tie-ins

Weld Pass	Electrode		Welding Direction	Amperage Range	Voltage Range	Travel Speed Range, mm/min
	Size (mm)	Class				
Root	4.0	E48010-G	Down	110-160	21-30	200-365
Second	4.0	E48010-G	Down	120-180	24-36	250-450
Fill(s)	4.5	E62018-G	Down	170-270	24-34	215-550
Cap	4.5	E62018-G	Down	180-260	22-34	170-430
Alternate Fill & Cap	4.0	E62018-G	Down	130-200	22-30	175-450

practices can be used with Grade 550 pipe using mechanized pulsed gas metal arc welding. Improvements in welding techniques and welding equipment configuration have been identified to reduce the incidence of recurring discontinuities.

Manual shielded metal arc welding procedures with low-hydrogen downhill SMAW electrodes can be used for the tie-in and repair welding of Grade 550 pipe. ♦

#### References

1. Pargeter, R. J. 1986. Field weldability of high strength pipeline steels. Final report to the Pipeline Research Committee of the American Gas Association on Project PR-164-415. AGA Catalog # L51507.
2. Rothwell, A. B. 1990. Assessment of cracking tests for pipeline steels. International Conference on the Metallurgy, Welding and Qualification of Microalloyed (HSLA) Steel Weldments. Houston, Tex.
3. Denys, R. 1990. Fracture behavior of large-diameter pipeline girth welds: Effect of weld metal strength. Interim report to the Pipeline Research Committee of the American Gas Association on Project PR-202-922.
4. Dorling, D. V., Huntley, R. M., Geertigs, J., and Rothwell, A. B. 1986. Pulsed gas metal arc welding of thick-section steels for low-temperature applications. Report prepared for Canmet by NOVA Corporation of Alberta. DSS File # 1-5Q.23440-4-9065.
5. Thompson, T. S., Rothwell, A. B., and Dorling, D. V. 1988. The influence of shielding gas composition on pulsed gas metal arc welding of arctic and offshore structures and pipelines. Report prepared for Canmet by NOVA Corporation of Alberta. DSS File # 03SQ.23440-6-9113.
6. Microalloying International Inc. 1990. Pulsed gas metal arc welding (PGMAW) of API 5LX-80 pipe. American Gas Association, Final report for Contract PR-187-821. AGA Catalog # L51610.
7. Glover, A. G., Hodgkinson, D., and Dorling, D. V. 1990. The application of mechanized ultrasonic inspection and alternative acceptance criteria to pipeline girth welds. International Conference on Pipeline Technology. Ostend, Belgium.

YOU CAN'T MISS THIS...

## SHEET METAL WELDING CONFERENCE

October 7,8,9, 1992  
Fairlane Holiday Inn  
Detroit, Michigan

The American Welding Society-Detroit Section urges you to attend this conference to discover the latest in state-of-the-art sheet metal welding technologies. AWS is sponsoring this phenomenal three-day event to help promote the advances in the sheet metal joining sciences.

Leading specialists and AWS members will be submitting technical reports and special presentations in both the fundamental and application areas of welding.

In addition, vendor contact booths will be on display to exhibit the prevailing automation controls, robotics and laser technologies.

Unfortunately, attendance is limited and the conference is expected to sell-out quickly. You must register immediately to secure reservations. For more information on the Sheet Metal Welding Conference V, contact the AWS-Detroit Section at (313) 549-0520.

DETROIT  SECTION

Circle No. 29 on Reader Info-Card

## Tempilstik®... the number one welding temperature indicator is also one of the world's most accurate.

When the Tempilstik® mark melts ... the temperature has been reached. Nothing could be simpler. The precise melting temperature gives visual control for measuring preheat, interpass, postweld heat treatment temperatures. Over 100 temperature ratings. Guaranteed to 1% accuracy. Meets all temperature requirements of AWS D1.1; ASME Code, Sect. I, III & VIII; ANSI/ASME Code B 31.1 & 31.3. Lot numbered for NIST traceability.

**Tempil** Division, Big Three Industries, Inc.

2901 Hamilton Blvd., So. Plainfield, NJ 07030  
(908) 757-8300  
FAX: (908) 757-9273



Circle No. 30 on Reader Info-Card.

Practical information for welders and others involved in welding and its allied processes.

## Gas Tungsten Arc Welding

Gas tungsten arc welding (GTAW) is a fusion process that utilizes a nonconsumable tungsten electrode. An arc is established between the electrode and the workpiece, and metal fusion may be assisted by the addition of a filler metal or it may be done without a filler metal.

This process is noted for its excellent quality welds and absence of spatter. It can be used to join a variety of ferrous and nonferrous metals.

Manual performance of this process is known to require dexterity and a greater eye-hand coordination than some other fusion processes, especially when filler metal is added. Arc initiation with manual welding is commonly accomplished with the scratch or touch start technique or by high-frequency starting.

A technique for manual welding is illustrated below. After the arc is established, a slight circular motion creates a molten pool. Once this is done, tilt the torch approximately 5 to 15 deg from vertical and proceed to weld, keeping the weld pool at a uniform width. Be careful not to tilt

the torch excessively or the shielding gas coverage of the weld pool may be compromised and air may be drawn into the shielding gas.

If filler metal is used, make sure it is cleaned of contaminants such as oil, oxides, dirt and grease. The filler rod should be held at approximately a 15-deg angle from the workpiece and fed at the leading edge of the weld pool. To add filler metal, the end of the rod should be dipped into the molten pool, being careful not to touch the tungsten electrode. It is incorrect to allow the end of the rod to melt and drip into the weld pool.

It is very important to keep the end of the rod, the weld pool and the electrode all within the area covered by the shielding gas. If the hot end of the rod is removed from the protective shield, that end can become contaminated by the atmosphere.

The whole process should be performed smoothly and uniformly.

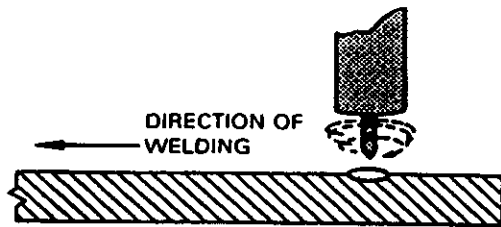

A Circular Motion Develops the Weld Pool

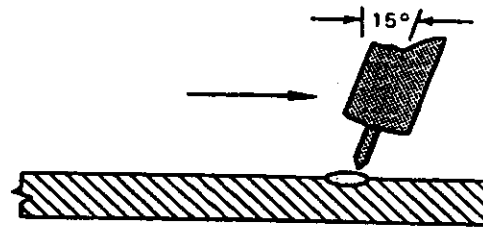

Electrode Moved to Trailing edge

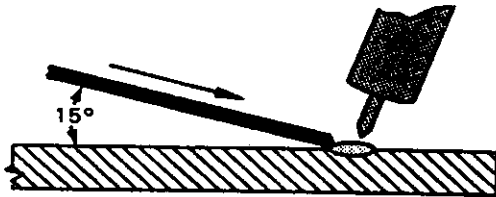

Filler Metal Added at the Leading Edge

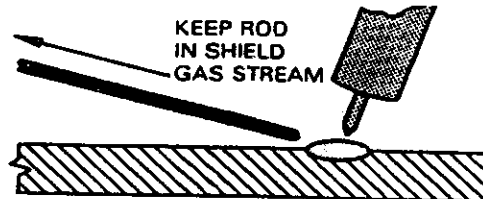

Withdraw Rod Slightly from the Weld Pool

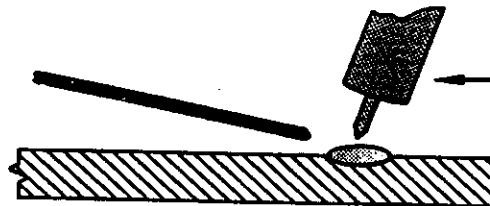

Move Electrode to Leading Edge and Repeat the Procedure when Needed

Excerpted from the *Welding Handbook*, Vol. 2, 8th edition.



# Gas Tungsten Arc Welding

The selection of electrode, current and shielding gas depends on the type of metal being joined and its thickness. The table below offers a guide for making those selections. Before welding, become familiar with the characteristics of the different electrodes, currents and shielding gases.

As with any welding process, any problems that arise require a careful evaluation of all factors involved in the operation (i.e., fixturing, equipment, procedures), but the table below on troubleshooting offers some possible solutions to common problems.

**Recommended Types of Current, Tungsten Electrodes and Shielding Gases for Welding Different Metals**

Type of Metal	Thickness	Type of Current	Electrode*	Shielding Gas
Aluminum	All over 1/8 in. under 1/8 in.	Alternating current DCEN	Pure or zirconium Thoriated	Argon or argon-helium Argon-helium or argon
Copper, copper alloys	All under 1/8 in.	DCEP DCEN	Thoriated or zirconium Thoriated	Argon Helium
Magnesium alloys	All under 1/8 in.	Alternating current DCEP	Pure or zirconium Pure or zirconium	Argon Argon
Nickel, nickel alloys	All	DCEN	Zirconium or thoriated Thoriated	Argon Argon
Plain carbon, low-alloy steels	All under 1/8 in.	DCEN Alternating current	Thoriated Pure or zirconium	Argon or argon-helium Argon
Stainless steel	All under 1/8 in.	DCEN Alternating current	Thoriated Pure or zirconium	Argon or argon-helium Argon
Titanium	All	DCEN	Thoriated	Argon

\*Where thoriated electrodes are recommended, ceriated or lanthanated electrodes may also be used.

## Troubleshooting Guide for Gas Tungsten Arc Welding

Problem	Cause	Remedy
Excessive electrode consumption	<ol style="list-style-type: none"> <li>Inadequate gas flow.</li> <li>Operating on reverse polarity</li> <li>Improper size electrode for current required.</li> <li>Excessive heating in holder.</li> <li>Contaminated electrode.</li> <li>Electrode oxidation during cooling.</li> <li>Using gas containing oxygen or CO<sub>2</sub>.</li> </ol>	<ol style="list-style-type: none"> <li>Increase gas flow.</li> <li>Use larger electrode or change to straight polarity.</li> <li>Use larger electrode.</li> <li>Check for proper collet contact.</li> <li>Remove contaminated portion. Erratic results will continue as long as contamination exists.</li> <li>Keep gas flowing after stopping arc for at least 10 to 15 seconds.</li> <li>Change to proper gas.</li> </ol>
Erratic use	<ol style="list-style-type: none"> <li>Base metal is dirty, greasy.</li> <li>Joint too narrow</li> <li>Electrode is contaminated.</li> <li>Arc too long</li> </ol>	<ol style="list-style-type: none"> <li>Use appropriate chemical cleansers, wire brush, or abrasives.</li> <li>Open joint groove; bring electrode closer to work; decrease voltage.</li> <li>Remove contaminated portion of electrode.</li> <li>Bring holder closer to work to shorten arc.</li> </ol>
Porosity	<ol style="list-style-type: none"> <li>Entrapped gas impurities (hydrogen, nitrogen, air, water vapor).</li> <li>Defective gas hose or loose hose connections.</li> <li>Oil film on base metal.</li> </ol>	<ol style="list-style-type: none"> <li>Blow out air from all lines before striking arc; remove condensed moisture from lines; use welding grade (99.99%) inert gas.</li> <li>Check hose and connections for leaks.</li> <li>Clean with chemical cleaner not prone to break up in arc; <b>DO NOT WELD WHILE BASE METAL IS WET.</b></li> </ol>
Tungsten contamination of workpiece	<ol style="list-style-type: none"> <li>Contact starting with electrode.</li> <li>Electrode melting and alloying with base metal.</li> <li>Touching tungsten to molten pool.</li> </ol>	<ol style="list-style-type: none"> <li>Use high frequency starter; use copper striker plate.</li> <li>Use less current or larger electrode; use thoriated or zirconium-tungsten electrode.</li> <li>Keep tungsten out of molten pool.</li> </ol>

## **PRACTICAL WELDER**

# **Orbital GTA Welding Used to Replace Tubing at Generating Plant**

BY BARBARA K. HENON

**E**ach year, TransAlta Utilities Corp. (TAU) of Calgary, Alberta, Canada, shuts down one of the six coal-fired units at its Sundance Generating Station for a major turbine inspection/overhaul. The six units at the station, located 70 kilometers west of Edmonton, Alberta, have a total capacity of 2100 MW. This extended outage also provides the opportunity to undertake major boiler repairs. This year, the 342 superheater bimetallic welds were scheduled for replacement. These welds, which join the stainless steel internal elements with the chromium-molybdenum external elements, had reached the end of their useful life.

### **Bimetallic Weld Replacement**

The superheater design conditions are 2475 psig at 1005°F. The bimetallic welds absorb thermal stresses attributed to varying expansion coefficients between dissimilar materials, in addition to normal pressure and temperature considerations. These stresses are accumulated due to periodic unit shutdowns for maintenance, resulting in a creep life weld limitation of nominal 100,000 operating hours. EPRI (The Electrical Power Research Institute) has carried out a number of studies into this problem, and has estimated that the first weld failure could be expected at an accumulation of 75,000 operating hours. The failures typically have been shown to propagate internally from the heat-affected zone (HAZ). Unit One at Sundance is now 20 years old, and running with an availability factor of 88%. It has accumulated more than 150,000 operating hours, and numerous bimetallic welds had already been repaired manually. It was clearly the time for replacement.

Floyd Mulligan, plant manager at the station, was looking for welding quality that would extend the life of the tube re-

placements. The plant had experienced several bimetallic weld failures in the past and these failures typically cost the company \$50,000 per day in lost revenue. Floyd wanted these replacements to allow the plant to operate with high reliability for up to an additional 200,000 hours. A new joint design was utilized for the bimetallic weld.

The new design used Inconel<sup>1</sup> as filler, instead of the original E 309 welding rod, and featured an altered weld profile with a wide cap. This design has shown a fourfold increase in the life of the weld on laboratory creep tests. Originally done as field welds, the replacement bimetallic welds for this project were shop fabricated off-site and TransAlta believes they won't require replacement during the remaining life of the plant. The shop-fabricated assemblies were four feet long, comprising two feet each of stainless steel and chromium-molybdenum tubing, and one central bimetallic weld. The work scheduled for the unit overhaul consisted

of removing the existing bimetallic welds (and adjacent tubing) and installing the replacement bimetallic weld assemblies.

### **Orbital Pipe Welding**

Traditionally, this work was carried out by several skilled craftsmen. The welding portion of the work, stainless steel (304-H) to stainless steel, and chrome-moly (T22) to chrome-moly, would require 20 to 26 qualified gas tungsten arc welders. On a similar project the previous year, the contractor working for TAU was unable to hire enough skilled workers to perform the work, and TransAlta was forced to recruit additional resources of manpower and orbital welding equipment, manufactured by Arc Machines, Inc. of Pacoima, Calif. During that project, the potential of the orbital welding equipment

1. Inconel is a trademark of the Inco family of companies.

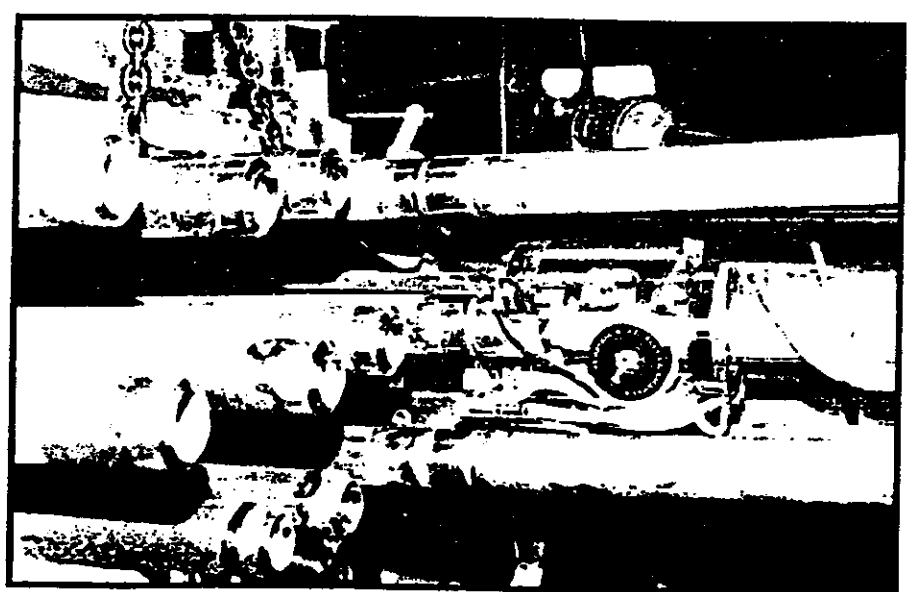

Fig. 1 — A weld head positioned on a superheater header tube in preparation for making a weld. When the weld head is mounted on the center tube as shown, clearance is just sufficient for locating the weld head. A finished weld can be seen in the foreground.

BARBARA K. HENON is with technical services, Arc Machines, Inc., Pacoima, Calif.

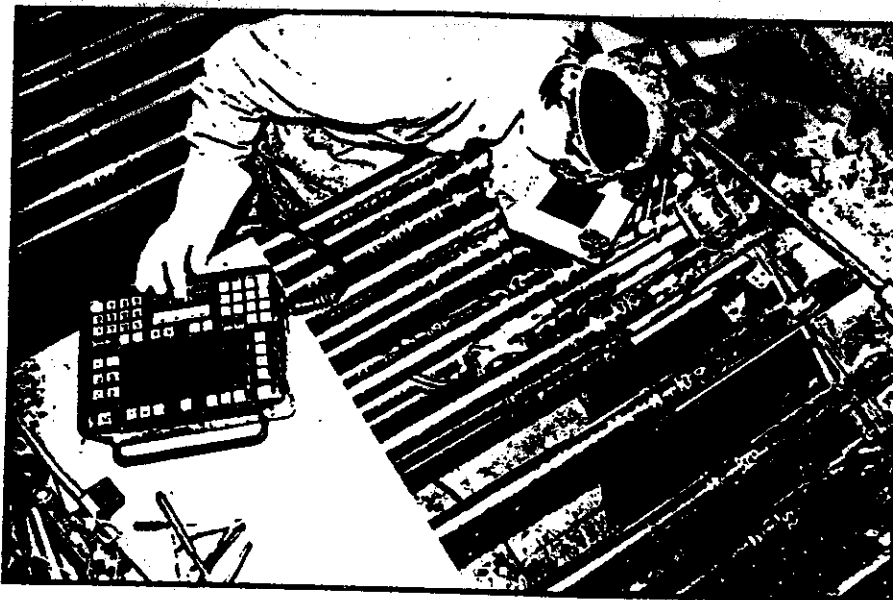

Fig. 2 — An orbital welding machine operator uses a program operator pendant to adjust the position of the weld head in preparation for welding the superheater header tube. Note the finished chromium-molybdenum-to-chromium-molybdenum welds and the layered arrangement of the tubing entering the superheater header.

was recognized by Steve Thomas, TAU senior engineering technologist.

TransAlta wanted to use the orbital welding equipment for the bimetallic weld replacement on the Sundance Unit #1. Working with Asea Brown Boveri, Inc. (ABB Combustion Services), planning was done to incorporate the use of the orbital welding equipment into the project. TAU selected ABB partly because of its considerable experience with the use of orbital welding equipment at other major utilities throughout Canada.

### Personnel Selection and Training

For the job at the Sundance Generating Station, a reliable source of trained manpower was again needed. In the Canadian power industry, major maintenance overhauls are scheduled for the summer months when the demand for power is less. During this time of year there is usually a shortage of manpower. ABB Combustion Services, at the time of the Sundance Unit #1 project, did not have a large enough staff of trained machine operators, and there was no available pool of trained operators. TAU, working closely with ABB, invested in the training of eight welders employed with ABB on a regular basis from the International Brotherhood of Boilermakers, Local 146. Local 146 is ABB's manpower supplier in the Alberta area for boiler maintenance. The local was very interested in orbital welding technology and felt that obtaining training for its members would give them a higher-

technology profile. The training took place at ABB's Edmonton office. Frank York, pipe welding product manager and welding specialist from Arc Machines, spent two 32 hour sessions, training four welders on the equipment in each session. Upon completion of their training, each welder had 64 hours of experience working with the equipment. Half of this time was spent on welding and half on performing joint preparation, all of which was under the supervision of ABB's senior orbital welding technician, Steve Chambers.

### The Scope of Work

The scope of work was carefully planned with a detailed estimate of the actual man-days required for each phase of the job. Daily goals were set for tube dressing, setup, fitting, welding the roots, x-ray, etc. The actual job was begun on August 2 and scheduled for completion on September 16. Everything possible was done to assure that the job would be done efficiently, smoothly and on schedule. TransAlta provided tools and essential equipment, including facing equipment to pre-

pare the tubing ends for orbital welding.

The human factor was considered as well. In order to minimize the time the men were away from the job, special air-conditioned lunchroom and washroom facilities were constructed on the seventh floor of the boiler building at the same level as the superheater header. Since the only elevator had a limited capacity and was rather slow, these specially built rooms contributed to the efficiency of the project.

A total of 684 welds had to be made in three weeks. The header tubes are arranged in 114 rows stacked three tubes deep with about 2 in. of radial clearance provided between the tubes. All tubing to be welded was 2 in. OD. The chromium-moly tubing had a wall thickness of 0.460 in., while the stainless tubing had a wall of 0.240 in. Before welding could begin, ABB's welding engineering technologist, Larrie Hermans, had to develop a qualified welding procedure that conformed to Sections I and IX of the ASME Boiler and Pressure Vessel Code. Weld Procedure Specifications (WPS), and Procedure and Performance Qualification Records (PQRs) were required to certify that both the process and the welding operators satisfied the requirements of the code.

The work was carefully planned by ABB and TAU. Steve Thomas (TAU), Brad Herczeg, ABB maintenance manager, and Spencer Allen, ABB site supervisor, worked to generate a viable plan that gave a realistic picture of the actual man-days needed to perform the job.

### Welding Equipment

Three Model 215 full-function micro-processor-controlled pipe welding power supplies were used on this project — Fig. 1. The qualified weld schedules listing the weld parameters for travel

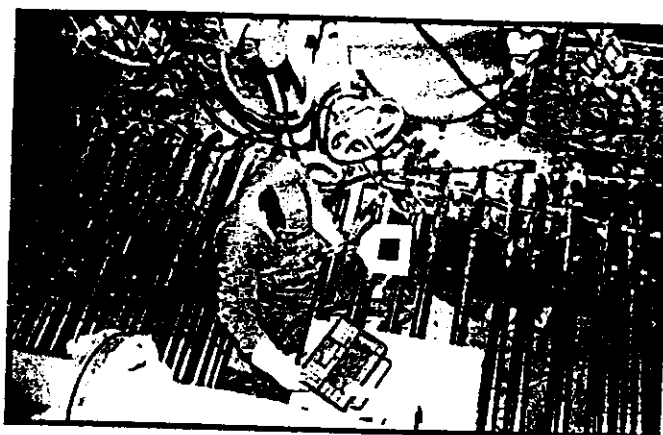

Fig. 3 — The welding operator controls the welding operation from the pendant while the weld head, which is positioned on the bottom row of the superheater header tubing, executes the weld.

speed, arc voltage control, welding currents, oscillation and wire feed speed were entered into the unit via the program operator pendant and stored in memory — Fig. 2. During the weld, slight steering of the torch was accomplished using the smaller auxiliary operating pendant. Four Model 81 water-cooled pipe welding heads were present on the site; one was kept to be used as a spare. The M-81 had a 1 7/8-in. extension for the end of the torch, which provided better visibility of the joint during welding and protected the weld head from excessive heat. The working space was very tight with a less than 2-in. clearance between the tubes — Fig. 3. In a few places, the tubes had to be slightly spread apart to accommodate the weld head, which has a nominal radial clearance of 1.75 in.

The tubes at one end of the header were welded first with the operators working toward the center on two of the machines (Fig. 4), and from the center toward the other end with the third machine, leaving a window of unwelded tubes to provide access for welding — Fig. 5. There was good crawl space under the lower row of tubing, but the center row of tubing was the hardest to reach. If these welds were done manually, the center row weld would have to be done with the welder reaching down from the top or up from the bottom. With the orbital equipment, it was possible to have a single operator on each machine, whereas if the job were to be done manually, two welders would be working on the same weld joint at the same time. Thus, the use of the automatic equipment eliminated some of the work that would be done with the manual welder in an uncomfortable position or in difficult-to-reach places.

### Production Techniques Lead to Increase in Productivity

During training, goals were set for the level of welding productivity that would be required to complete the project successfully. Although a learning curve was expected, the operators were produc-

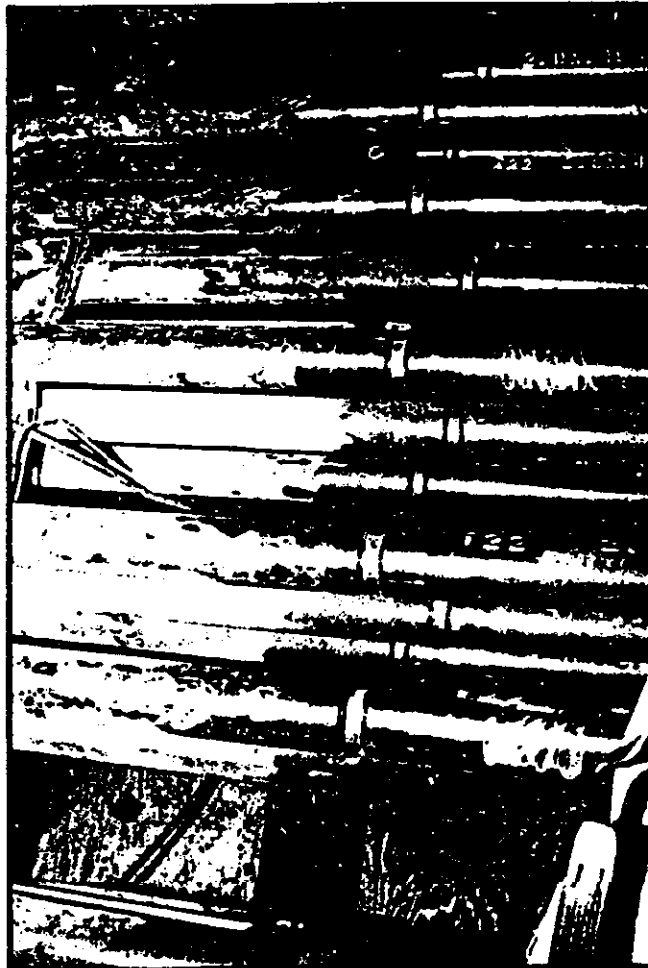

Fig. 4 — Partially completed chromium-molybdenum-to-chromium-molybdenum welds on superheater header tubes. The root pass and first fill pass are done first and then must pass radiography inspection before the final fill and cap passes can be done.

tive from the start of the replacement project. With three eight-hour shifts in operation five days a week, the productivity level averaged about eight welds per shift per machine. Some operators were able to double this rate.

On previous projects done with manual welding technology, radiography was a constraint to productivity and a time window to perform the radiography was required. On this project, they

were able to save time by scheduling the radiography to be done on the weekends.

ABB developed a number of time-saving fabrication techniques for cutting and purging. This was done to give TAU the best possible cost, as this project was done on a time and materials basis. Arc Machines cooperated by having Frank York on site to advise them and keep the welding operation going. After the start of the job, they were able to save a significant amount of welding time by reducing the number of passes on the stainless-to-stainless welds from four to three. The chrome moly-to-chrome moly weld required eight passes to complete. The stainless-to-stainless welds were done first so that these welds could be purged with inert argon gas during welding. Purging with argon protects the weld surface from oxidation and provides a cleaner, higher quality weld. The soluble purge dam material that was used was removed during hydrotesting. The welding operations were consistently below the estimated man-days for welding, but these improvements were, to some extent, consumed by extra time needed for precision fit-up.

ABB estimates that this job, done with orbital welding, was about 25% more efficient than a similar job done two

years before with manual GTAW. In addition, there is now a core of trained personnel that can be tapped for future jobs.

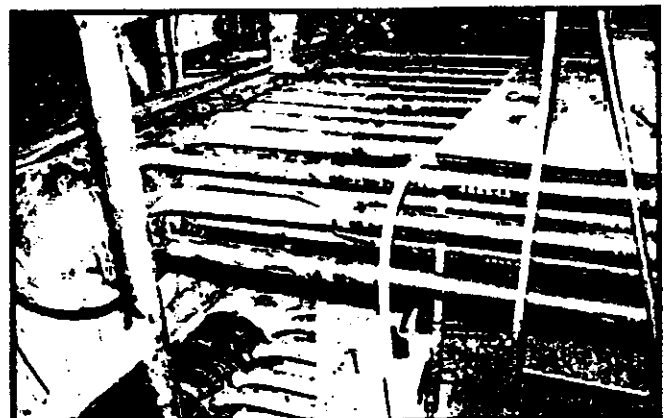
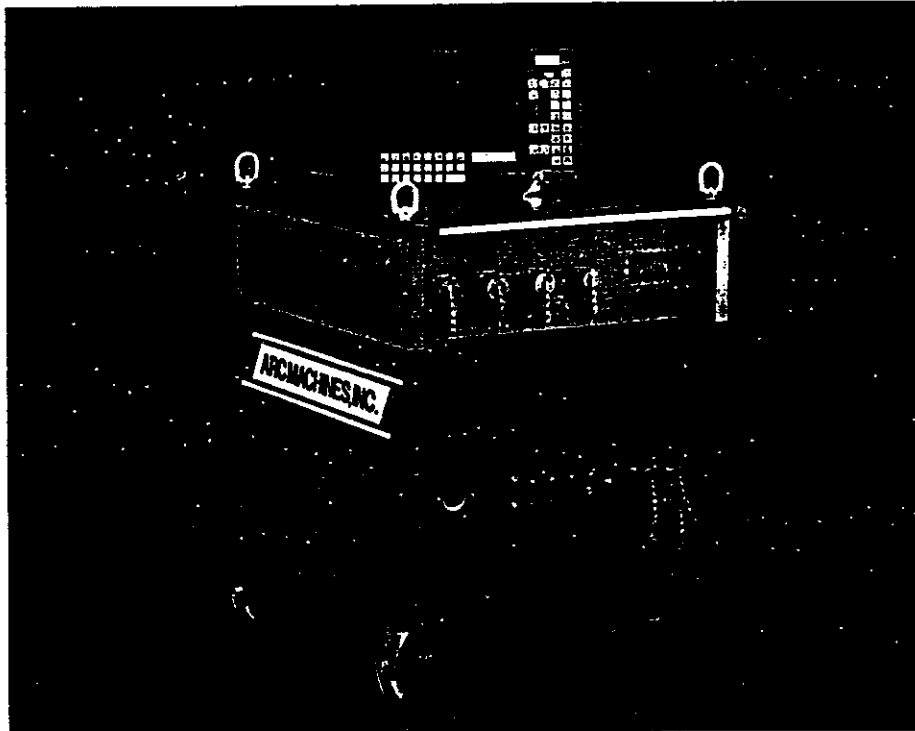

Fig. 5 — Finished welds show three-deep arrangement of superheater heading tubing as they enter the header at left.



## ARC MACHINES, INC.

### MODEL 215 MICROPROCESSOR-CONTROLLED POWER SUPPLY



- Easy to program and use. Each screen is prompted in English, French and German (other languages available)
- Solid-state pulsed 350 amps DC GTAW Power Supply, 100% Duty Cycle
- High capacity memory for storage of weld schedules
- Operator overrides on 14 essential welding variables. Amount of override can be controlled by the user from 0% to 100%
- Compatible with all standard Arc Machines' weld heads
- Operates up to 200 feet away from weld head
- Complete line of options and accessories
- Built-in diagnostic features

**HEADQUARTERS:**  
 Arc Machines, Inc.  
 10280 Glenoaks Blvd.  
 Pacoima, CA 91331  
 U.S.A.  
 Tel: 1-818-896-9556  
 Fax: 1-818-890-3724

**EUROPEAN OFFICE:**  
 Arc Machines, Inc.  
 Chemin du Lavasson 2  
 CH-1196 Gland  
 Switzerland  
 Tel: +41 / 22 / 995.00.51  
 Fax: +41 / 22 / 995.00.59

**GERMAN OFFICE:**  
 Arc Machines GmbH  
 Markelsbach 2  
 D-53804 Much  
 Germany  
 Tel: 02245 / 91680  
 Fax: 02245 / 916868

**UK OFFICE:**  
 Arc Machines UK Limited  
 Unit 31, Derwent Business Ctr.  
 Clarke Street  
 Derby, DE1 2BU England  
 Tel: 01332 / 291888  
 Fax: 01332 / 291295

## MODEL 215 MICROPROCESSOR-CONTROLLED POWER SUPPLY

The Arc Machines Model 215 microprocessor-controlled power supply is a field-proven GTAW power supply which represents the latest in state-of-the-art technology. It is a solid-state pulsed 300 amps DC power supply with a 100% duty cycle. The Model 215 operates all standard Arc Machines welding heads and is an extremely versatile power supply with a strong emphasis on ease of operation. Each programming screen is prompted in plain English assuring the user simple and fast programming of weld schedules. No computer codes are used.

The memory system of the Model 215 is capable of storing a large number of weld schedules. Each individual weld schedule may consist of up to 100 passes with 38 variables and each pass may contain up to 100 levels with 17 variables. These combinations allow virtually unlimited versatility.

The Arc Machines Model 215 can be stationed up to 200 feet away from the weld location. All controls necessary to operate the Model 215 are located on a small, portable, hand-held programmer-operator pendant, which can be located at the weld site or near the power supply. When welding in a hazardous environment is mandated, the Model 215 has a remote welding option which allows the operator to monitor the weld on a TV screen while maintaining a safe distance from the hazardous area.

### The Arc Machines Model 215 Offers:

- Solid-state, precision, pulsed GTAW power supply
- Operates all standard AMI welding heads
- Complete operation and programming at weld head location
- Alpha-numeric graphic display of all weld information and function values, plus patented "Heads-Up" display available with remote pendant
- Large-capacity memory for storage of all weld schedule information and function values
- Display of system operation instructions (operator prompting)
- Rapid input of weld schedule information
- Fourteen user-controlled overrides, programmable from 0% to 100%
- Complete line of accessories available
- Detects and indicates faults such as: ground, temperature, gas flow, coolant flow, internal voltages, etc.
- Current pulsation synchronized with oscillation, dwell, wire feed and travel

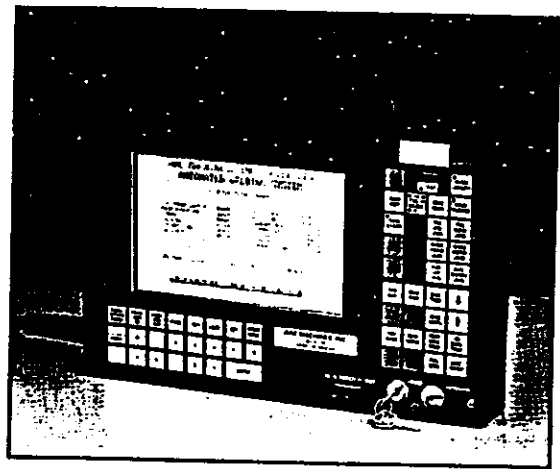

Model 215 Program Operator Pendant

Complies with all applicable international norms and directives, including: IEC 974-1; ISO/DIS 700; EN 50199; EN 60974-1.

### Technical Data:

Process:	GTAW (TIG)	Arc Start System:	High frequency or touch start
Weld Current:	5 to 350 amps DCSP $\pm 1\%$ , 100% Duty Cycle	Input Power:	230 / 460 VAC, 3 phase 60 Hz. Other ratings available.
Arc Voltage Control:	5 to 20 volts (Closed loop position servo)	Dimensions:	Height: 36.00" Width: 24.00" Depth: 42.00"
Travel/Rotation Speeds:	Range depends on weld head type	Memory Capacity:	Up to 254 weld schedules Up to 100 passes per schedule Up to 100 levels per pass
Wire Feed Speed:	1.0 to 200 IPM synchronized to pulsation and oscillation	Overrides:	Programmable from 0% to 100%
Torch Oscillation:	Range depends on weld head type	Applicable Spec:	Specification No. 215
Cooling System:	Liquid cooled. Filtered forced-air heat exchanger		

Specifications subject to change without notice.

**ARC MACHINES, INC.**

One Year Limited Warranty

Made in the U.S.A.



## ARC MACHINES, INC. MODEL 8 NARROW WELD HEAD

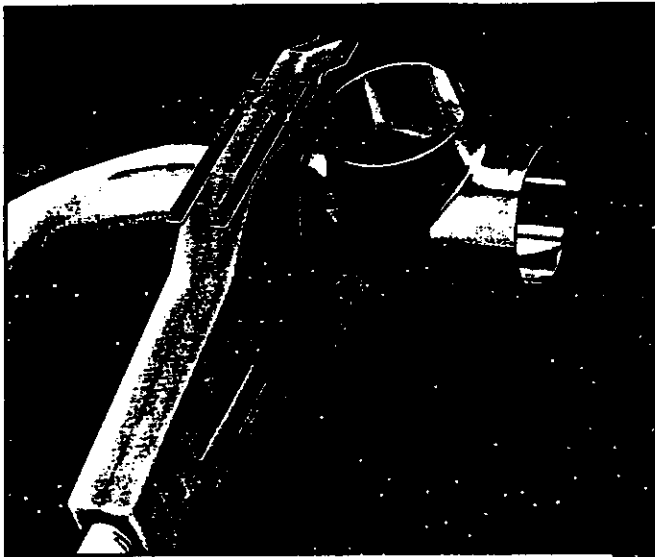

*Shown with fitting-to-fitting weld*

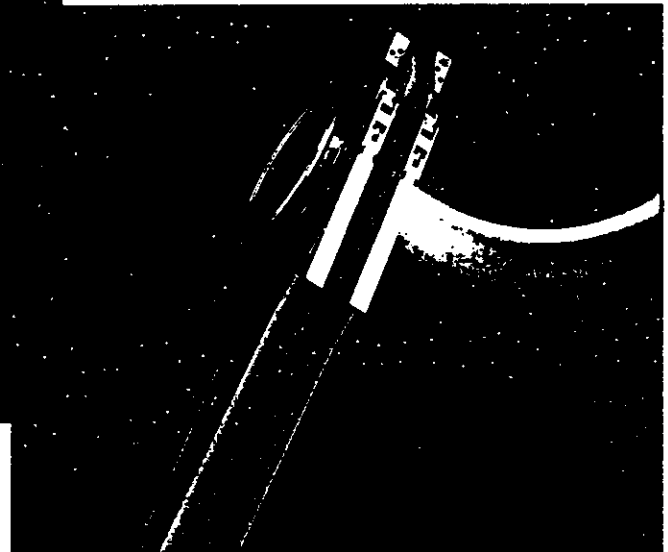

*Shown with fitting-to-ferrule*

### Ideal For:

- Fabrication shops
- Food, dairy and beverage industries
- Biomedical / pharmaceutical installations
- Semiconductor fabrication facilities and high-purity piping installations
- Vacuum and exhaust fittings
- CIP panel construction and valve clusters / headers
- Sanitary ferrule and short-tangent weld fittings

### Features:

- Orbital weld head for fusion welding of fitting to fitting, fitting to tube, and tube to tube applications
- Narrow head width accommodates all "standard" tube fittings
- Highly efficient liquid cooling of both internal and external components allows high duty cycle usage
- Range: 1.00" O.D. to 4.00" O.D. (25,4mm to 101,6mm O.D.)
- All-gear drive mechanism

**HEADQUARTERS:**  
Arc Machines, Inc.  
10280 Glenoaks Blvd.  
Pacoima, CA 91331  
U.S.A.  
Tel: (818) 896-9556  
Fax: (818) 890-3724

**EUROPEAN OFFICE:**  
Arc Machines, Inc.  
Chemin de la Crétaux  
CH-1196 Gland  
Switzerland  
Tel: +41 / 22 / 364.1064  
Fax: +41 / 22 / 364.1809

**GERMAN OFFICE:**  
Arc Machines GmbH  
Schmerbachstrasse 9  
D-53804 Much  
Germany  
Tel: 02245 / 5868  
Fax: 02245 / 5965

**UK OFFICE:**  
Arc Machines UK Limited  
Unit 31, Derwent Business Ctr.  
Clarke Street  
Derby, DE1 2BU England  
Tel: 01332 / 291888  
Fax: 01332 / 291295

# MODEL 8 NARROW WELD HEAD

The Model 8-4000 weld head is an orbital weld head for fusion TIG (GTAW) welding of fittings, tubing and thin wall pipe. The narrow width of this head makes it ideal for limited clearance applications, such as welding fitting to fitting or fitting to valve body assemblies. Welds materials such as stainless steel, titanium, Hastelloy and other autogenously weldable alloys.

A key feature of the Model 8-4000 weld head is its unique cooling design, allowing high duty-cycle welding. When connected to an AMI cooling unit, all components of this weld head are liquid-cooled, including cables, upper and lower clamp housings and electrode rotor (patent pending).

A variety of clamps are available to perfectly suit every welding application. For fitting-to-fitting welds the standard Model 8 (narrow) clamps require the least amount of stick-out. Where more stick-out is available (sizes up to 3.500" O.D. or 88,9mm), an adapter ring may be used in conjunction with Model 9-3500 standard or 9E-3500 extra wide clamp inserts, providing maximum grip and support, and allowing the usage of existing customer's inventory.

To weld fittings or ferrules with dimension "T" less than shown here, please contact AMI factory, sales offices or one of our representatives for recommendations.

Weld Head Model No.	Tube/Pipe O.D. Range	Dimensions								T minimum
		A	B	C	D	E	E1*	E2**	F***	
8-4000	1.00-4.00" 25,4-101,6mm	16.19" 411,2mm	3.81" 96,8mm	3.75" 95,2mm	7.50" 190,5mm	0.85" 21,6mm	1.02" 25,9mm	2.14" 54,3mm	1.70" 43,2mm	0.85" 21,6mm

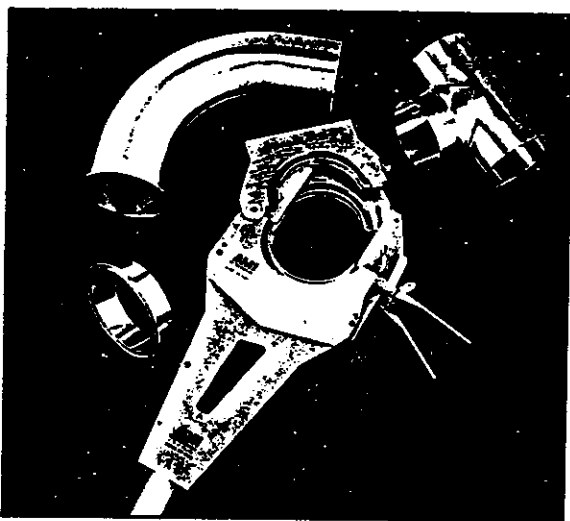

Model 8-4000 shown with representative sanitary fittings

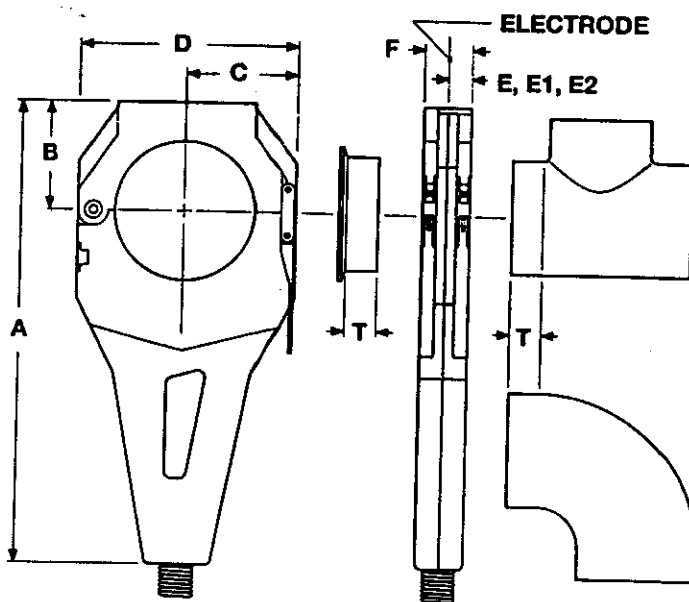

- \* "E" dimension with standard Model 8 narrow clamp insert
- \*\* "E1" dimension with adapter ring & standard Model 9 clamp insert
- \*\*\* "E2" dimension with adapter ring and extra wide Model 9 clamp insert
- \*\*\* "F" dimension with standard Model 8 narrow clamps

## Technical Data

Process:	GTAW (TIG) Fusion only	Electrode Size:	1/16" and 3/32"
Travel Motor:	D.C., P.M., D.C. Tachometer	Rotor RPM:	0.1 to 5.0
Head Weight:	10 lbs. (less cables)	Cable Length:	25 Ft. including adapter cable
Recommendation:	Water cooling unit		Extension cables are available

Specifications subject to change without notice

# ARC MACHINES, INC.

One Year Limited Warranty

Made in the U.S.A.



**ARC MACHINES, INC.  
MODEL 15  
LARGE-DIAMETER PIPE WELD HEAD**

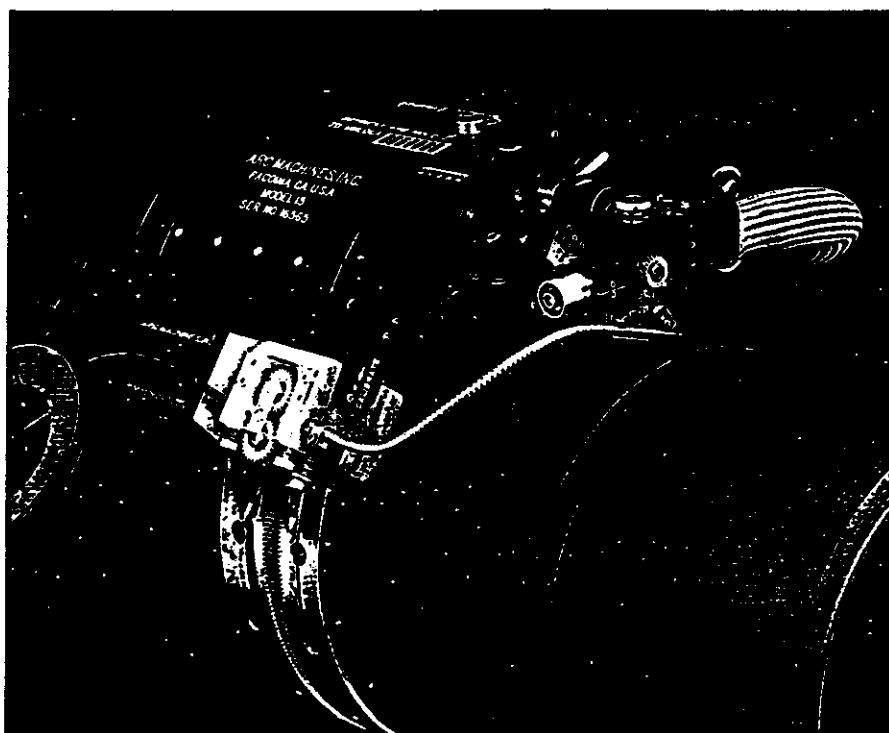

- Rugged, compact weld head with water-cooled torches
- Exclusive, zero-backlash gear drive (no friction drives) for positive, consistent travel speeds (uphill or downhill) in all positions
- Range from 3" pipe through all standard pipe sizes, such as 6", 8", 10", 12" up to any diameter. Flat track for flat plate welds and large-radius curved track are available
- Extremely quick mount / dismount
- Cross-seam steering
- Synchronized torch oscillation, AVC, rotation and wire feed
- On-board wire feed mechanics, single or dual wire feed system
- Compatible with AMI Model 215 or Model 227 Power Supplies

**HEADQUARTERS:**

Arc Machines, Inc.  
10280 Glenoaks Blvd.  
Pacoima, CA 91331  
U.S.A.

Tel: (818) 896-9556  
Fax: (818) 890-3724

**EUROPEAN OFFICE:**

Arc Machines, Inc.  
Chemin de la Crétaux  
CH-1196 Gland  
Switzerland

Tel: +41 / 22 / 364.1064  
Fax: +41 / 22 / 364.1809

**GERMAN OFFICE:**

Arc Machines GmbH  
Schmerbachstrasse 9  
D-53804 Much  
Germany

Tel: 02245 / 5868  
Fax: 02245 / 5965

**UK OFFICE:**

Arc Machines UK Limited  
Unit 31, Derwent Business Ctr.  
Clarke Street  
Derby, DE1 2BU England

Tel: 01332 / 291888  
Fax: 01332 / 291295

# Model 15 Narrow-Gap Torch

The narrow-gap torch was designed to promote positive fusion of weld-joint side walls in heavy-wall pipe and vessel welds, with less heat input and quicker weld times than conventional equipment now being used. This torch uses a rotating tungsten, which provides mechanical manipulation of the arc and wire feed within the groove. The integral gas cup provides direct gas shielding of the tungsten and the weld metal. This combination, in conjunction with narrow preps, allows deposition rates that are higher than conventional cold-wire GTAW. Current weld preps being used are approximately 1/2" wide, in the root area, with a 3 to 9 degree included angle for welds up to 4" thick. The clean, compact torch design simplifies process operation so that no special training is required for operators familiar with AMI orbital pipe welding equipment.

Narrow Groove Data: 30" OD, 4" Wall Pipe

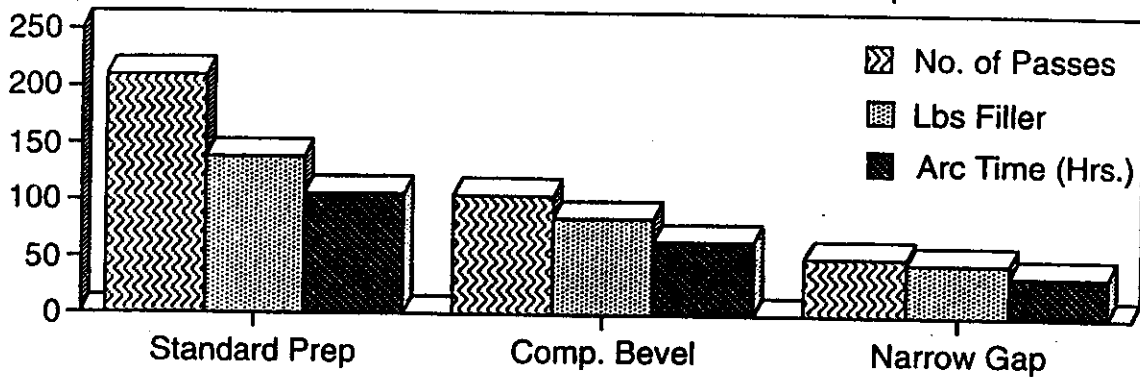

Consult Arc Machines, Inc. for applications assistance

## Offers:

- Suitable to weld up to 6" wall thicknesses
- Excellent remote visibility. Equipped with 2 video cameras
- Torch set-up in 2" increments to minimize radial clearance
- Reduces weld time
- Wire size range: 0.030 - 0.045"
- Torch: Water-cooled, 350 amp
- Optional 0.375" wide gas cups for special applications
- Actual weld groove (joint prep) depends on the type of material being joined, component geometry and restraint

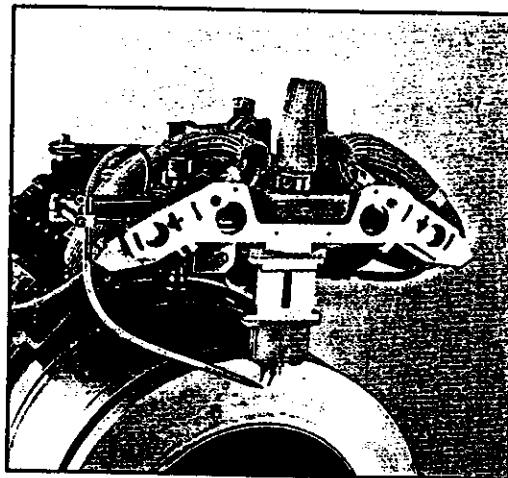
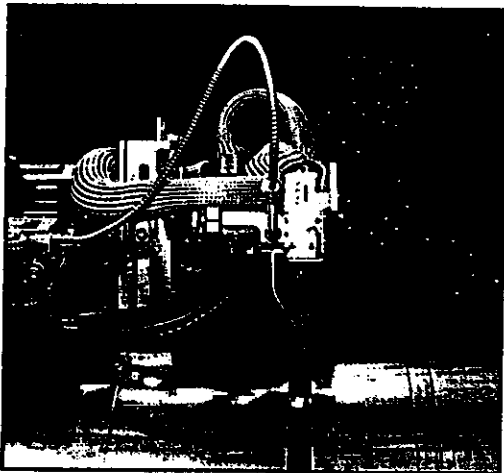
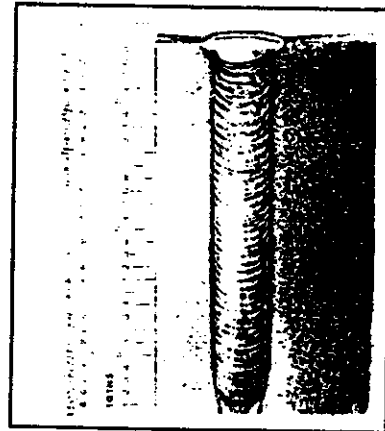

**ARC MACHINES, INC.**

## Model 15 Options

**AVC / Oscillator Interchange:** Allows the AVC Servo to be used as the oscillator and allows the oscillator servo to be used as the AVC. Required when torch is tilted to be parallel with axis of the weld head. (Used for buttering, nozzle build-up, bulkhead or similar welds)

**AVC Reversal:** Allows for the torch to be mounted upside down and the AVC to operate in reverse. (Required for large diameter I.D. welding)

**Right-Angle Drive:** Allows the weld head to be mounted perpendicular to the pipe instead of parallel to it. Used for short radius elbows or tight axial clearance in conjunction with AVC / OSC Interchange.

**AVC Tilt:** Allows the torch and AVC movement to be tilted up to a 60 degree angle. (Required for fillet and socket welds)

contact Arc Machines.

**15-CW Wire Feeder and Spool Holder:** Additional (second) wire feeder. Allows welding in both directions of head travel; the power supply automatically selects proper wire feeder as a function of rotation direction.

**Short or long radius elbow:** (Consult Arc Machines, Inc.)

**Gas Cup / Gas Lens / Wire Manipulator Extender:** This multi-part option allows most torches to be used to weld pipe with up to 5" wall thickness.

**Cables:** Extension cable assemblies are available which allow weld head operation up to 200 feet from the power supply.

**Large Wire Spool Holders:** Allows use of 8" (10 lb.) or 12" (30 lb.) wire spools under certain limited conditions.

**300 IPM Wire Feed Motor:** For use with special-application torches.

For application requiring more torque or faster travel.

### Technical Data

Torch AVC Stroke:	1.75"	Amplitude, max.:	1.00"
Travel Speed:	0.1 to 20 IPM	Wire Manipulator:	Vertical, Horizontal and Angular
Wire Feed Speed:	5 to 200 IPM	(Manual Art)	0.020 - 0.045",
Torch:	Water-cooled, 300 ADC	Filler Wire:	Standard: 0.035"
Torch Adjustments:	100% duty cycle	Wire Spool Size:	2 lb., 4" standard spool
Tungsten Size:	Torch specific	Radial Clearance	Depends on pipe diameter,
Torch Cross-seam	3/32", 1/8" or 5/32"	Range:	torch type and configuration;
Steering Range:	2.00"	Axial Clearance	3.750" (minimum)
Max. Wall Thickness:	Depends on torch type,	Range:	Depends on torch type and
		Outline Drawing:	options; 11.5" (minimum)
			40150075, 40150057, 40150055
			40150070, 40150036, 40150058

*Specifications subject to change without notice.*

## ARC MACHINES, INC.

One Year Limited Warranty

Made in the U.S.A.