

## 1.0 INTROLUCTION

The aim of this seminar handbook is to give an appreciation of the possibilities of the range of metal joining techniques known collectively as welding. The seminar touches on design for welding, welding processes, weldment quality, the use of symbols on drawings for welding and nondestructive examination, and codes & standards.

The coverage is nevertheless brief almost to the point of being superficial. Several crucial aspects of the design of weldments are merely skimmed. Many economically-important welding processes used outside the construction field have been left out, and much of welding metallurgy is completely ignored.

Full coverage of these topics would require many more hours than are available. For those who require more specialized information, references and further reading are given under each of the main headings.

## 2.0 DESIGN FOR WELDING

### 2.1 Welding - One of Several Joining Methods

Welding is practically indispensable today. Nuclear power stations, chemical plants, ships and aircraft could not exist in their present forms without the strong, reliable joints provided by welding. At the same time, welding processes help build low-cost mass-produced consumer goods from tin cans to autos.

Welding is however only one of several joining processes which the designer may choose:

#### COMPETING METAL-JOINING PROCESSES

<u>Process</u>	<u>Example</u>
Welding	pressure vessels
Brazing	gas turbine blading
Soldering	electronic components
Rivetting	truck bodies
Bolting	structural steel
Adhesives	aircraft
Unitary construction	(make it in one piece: - by casting, forging, bending, etc.)

Welding is never the only design solution. It can have undesirable side-effects, including distortion, residual stress, impaired corrosion resistance and damage to surface finishes. Select welding when:

- welding offers the most satisfactory joint quality when joint quality is paramount (eg. pressure vessels)

- welding is the low cost production method when cost is paramount (eg. office furniture)

## 2.2 Welding Joint Design

Common welded joint types are shown in Figure 1.

The loads in a welded structure are transferred from one member to another through the welded joints. The designer selects a joint type primarily for the strength required and the service conditions in which the joints will perform. The manner in which the stress is applied must be considered, whether tension, shear, bending or torsion. Different joint designs are called for if the load is fluctuating, when fatigue is a factor. Joints may be designed to avoid stress concentrations and to minimize residual stresses. Corrosive service conditions may require joints that are free from crevices or other irregularities that make them susceptible to attack.

Many application Codes contain specific rules for weld joint design and manufacture (eg. joint strength factors and permissible joint configurations) for the guidance of the designer - as in for instance the ASME Boiler and Pressure Vessel Code or the CSA Standard for Welded Steel Construction.

In addition to the above, joints are detailed for economy and ease of manufacture. Good access and simple weld configurations make it easy for the welder to produce good workmanship and sound welds. Particular joint configurations and surface finish may also be needed to facilitate inspection and nondestructive examination.

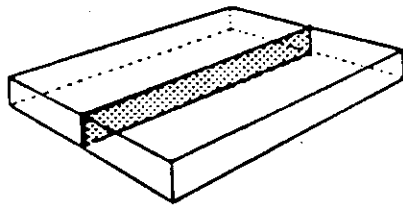

**Applicable welds**

- |               |                    |
|---------------|--------------------|
| Square-Groove | J-Groove           |
| V-Groove      | Flare-V-Groove     |
| Bevel-Groove  | Flare-Bevel-Groove |
| U-Groove      | Edge-Flange        |

(1A) Butt joint

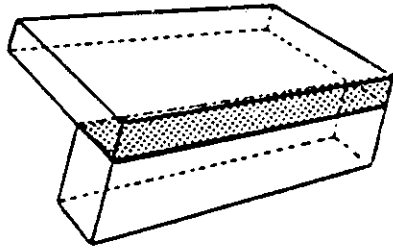

**Applicable welds**

- |                |                    |
|----------------|--------------------|
| Fillet         | Flare-Bevel-Groove |
| Square-Groove  | Edge-Flange        |
| V-Groove       | Corner-Flange      |
| Bevel-Groove   | Spot               |
| U-Groove       | Projection         |
| J-Groove       | Seam               |
| Flare-V-Groove |                    |

(1B) Corner joint

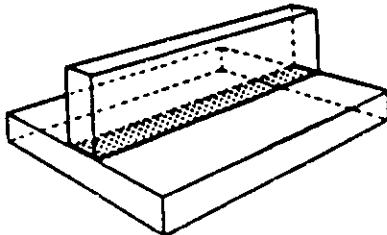

**Applicable welds**

- |               |                    |
|---------------|--------------------|
| Fillet        | J-Groove           |
| Plug          | Flare-Bevel-Groove |
| Slot          | Spot               |
| Square-Groove | Projection         |
| Bevel-Groove  | Seam               |

(1C) T-joint

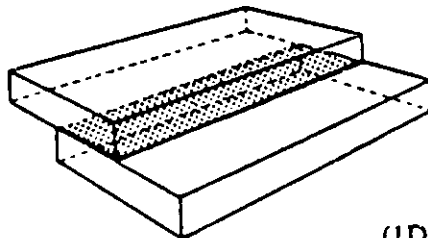

**Applicable welds**

- |              |                    |
|--------------|--------------------|
| Fillet       | J-Groove           |
| Plug         | Flare-Bevel-Groove |
| Slot         | Spot               |
| Bevel-Groove | Projection         |
|              | Seam               |

(1D) Lap joint

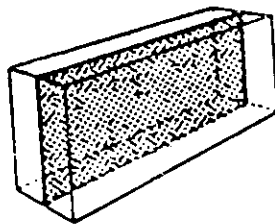

**Applicable welds**

- |               |               |
|---------------|---------------|
| Plug          | Edge-Flange   |
| Slot          | Corner-Flange |
| Square-Groove | Spot          |
| Bevel-Groove  | Projection    |
| V-Groove      | Seam          |
| U-Groove      | Edge          |
| J-Groove      |               |

(1E) Edge joint

Figure 1: TYPES OF JOINTS

### 2.3 Weld Types and Joint Preparation

Two common weld types are fillet welds and groove welds, as illustrated in Figure 2.

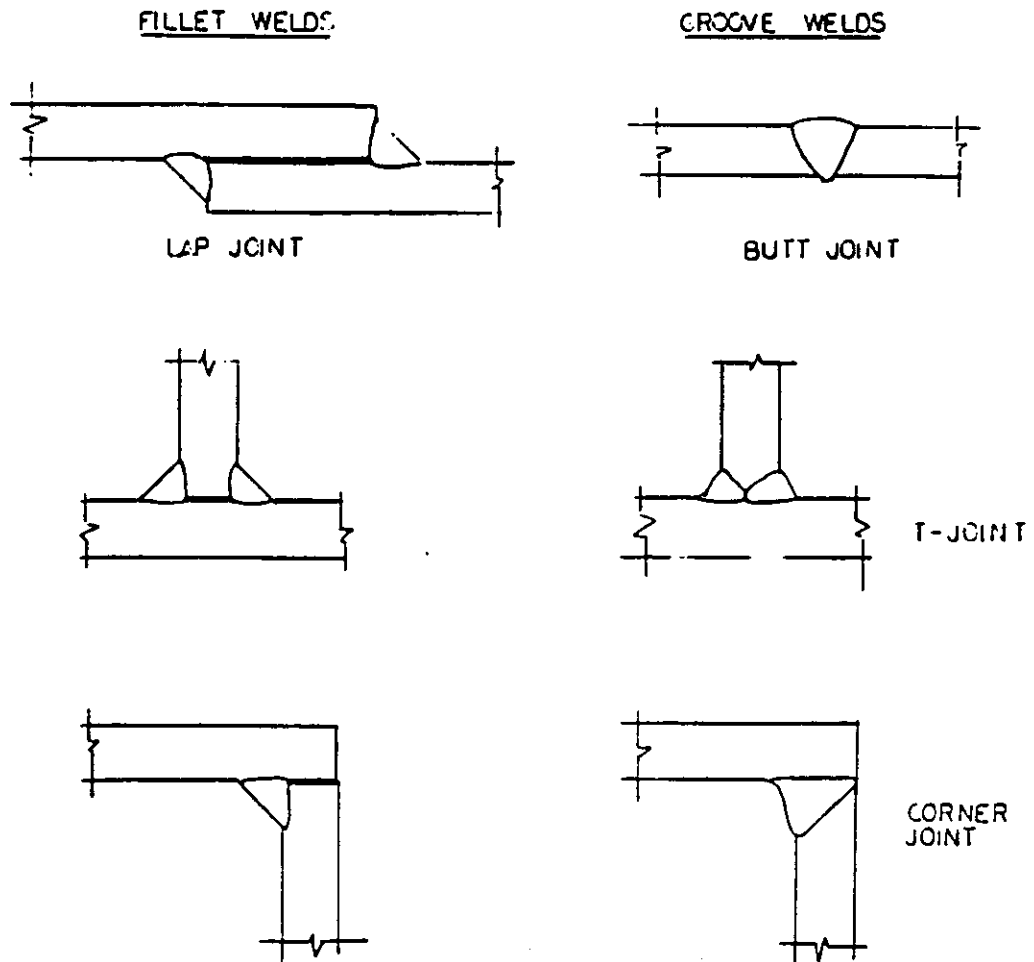

Figure 2: FILLET & GROOVE WELDS IN COMMON JOINT ARRANGEMENTS

Fillet welds consist of a triangular weld deposit joining two members which are approximately at right angles, without fusing all of the joint. Fillet welds are used in lap, T and corner joints, and are very simple to prepare and fit up. Where the design permits, fillet welds are used in preference to groove welds for economy.

Groove welds consist of weld metal deposited in a groove or bevel formed on the edges of the adjoining parts. If the groove extends only part way through the joint, the weld is termed a "partial-penetration" groove weld. In "full-penetration" welds, the entire joint is fused.

"Square groove" welds are made by butting together two sections, with a slight gap if necessary to aid penetration. The maximum thickness that can be penetrated depends on the welding process, ranging from about 0.15 inch for Gas Tungsten Arc Welding (GTAW) to about 1/2 inch for Submerged Arc Welding (SAW). In thicker sections, the joint edges must be bevelled to give access to the root of the joint, and the groove is progressively filled in one or more passes.

Obtaining a satisfactory weld root can be tackled in several ways. If both sides of the joint are accessible, a sealing pass can be deposited after grinding back the root to sound metal. Alternatively, a backing strip tack-welded across the joint beforehand will support the first few weld runs. Backing strips can sometimes be left in place, but if considered objectionable must be removed after welding. When a joint must be welded from one side only, in pipes for example, satisfactory penetration and root profile is often achieved using GTAW for the root pass, which allows good control of the amount of fusion. Accurate joint preparation and fit-up is needed.

In larger thicknesses, the cross-sectional area of a single bevel groove is large and needs a lot of welding to fill it. Above a certain thickness, the amount of weld metal needed can be profitably reduced by preparations having

a smaller volume such as J preparations, compound bevels, and double-V grooves.

Because the choice of weld preparation depends on welding process and technique as well as on purely technical considerations, it is advisable for the designer to consult with the manufacturer or fabricator before specifying details of weld preparations, or at least to adhere to some recognized standard.

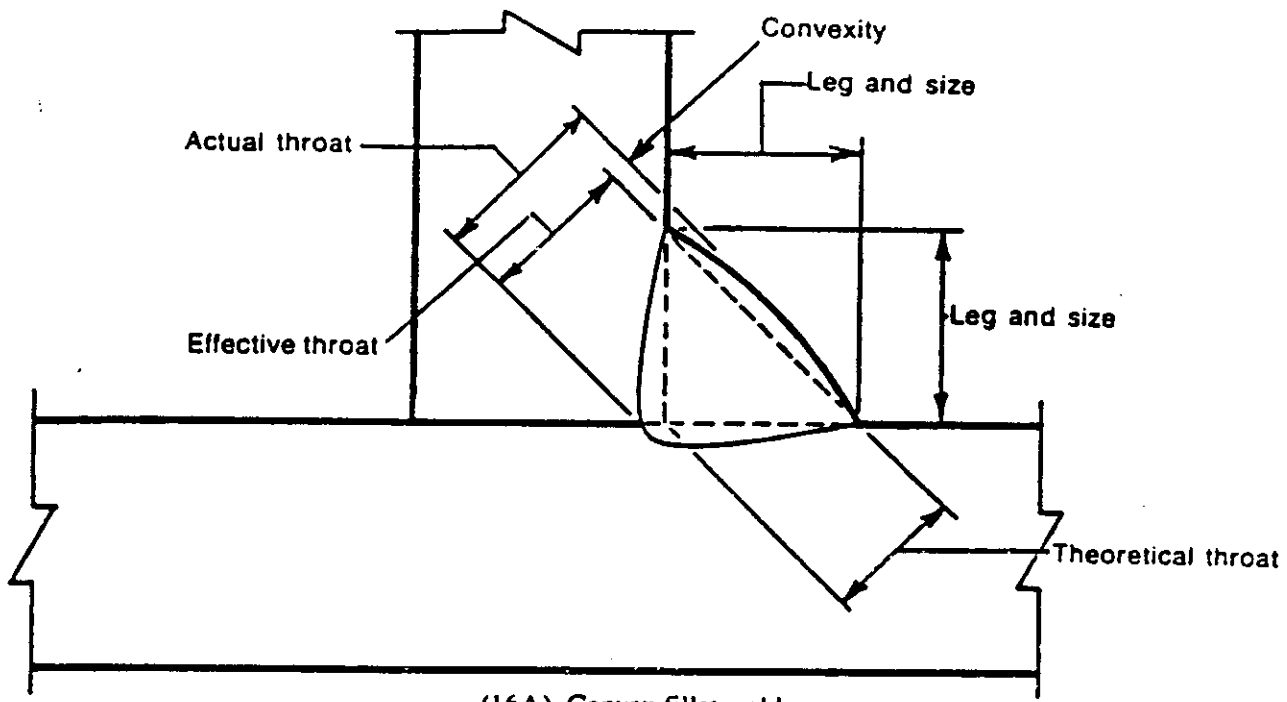

(16A) Convex fillet weld

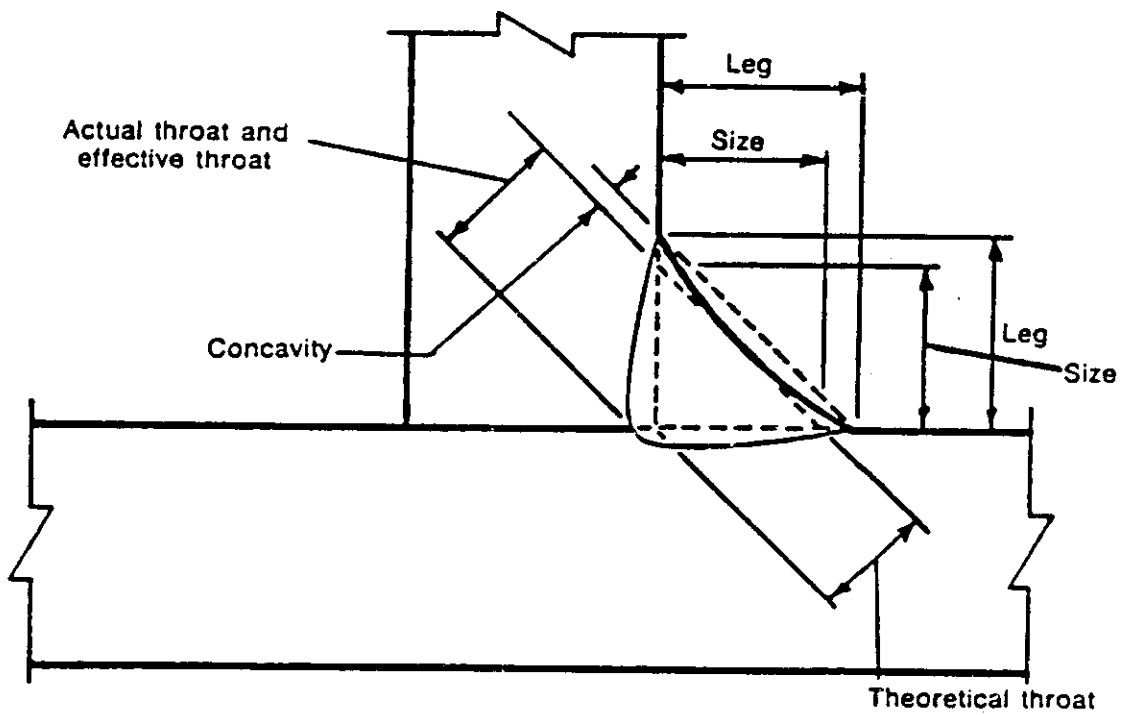

(16B) Concave fillet weld

Figure 3(a) FILLET WELD TERMINOLOGY



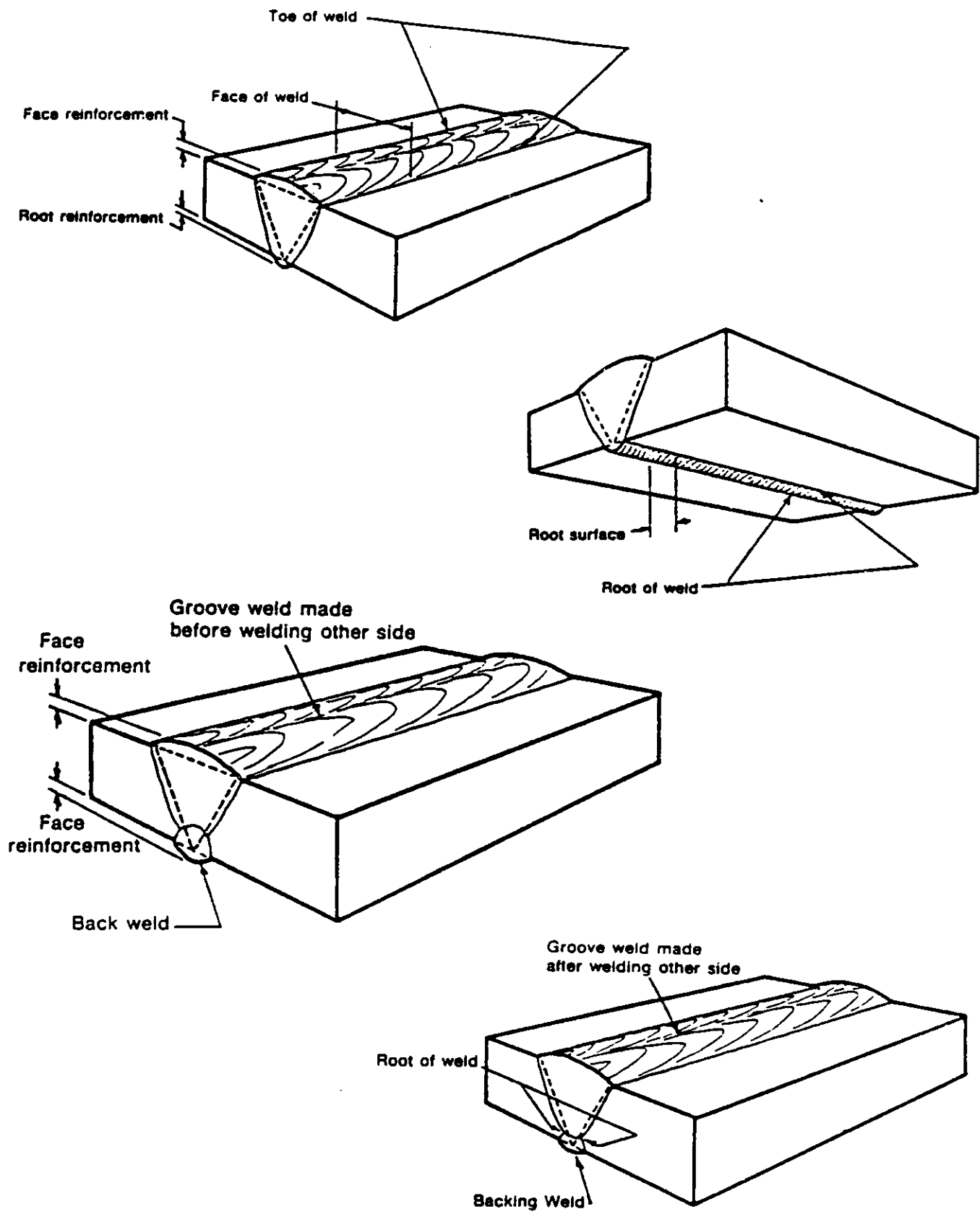

Figure 3(b): GROOVE WELD TERMINOLOGY

## 2.4 Static Strength of Welded Joints

Fillet welds and partial penetration welds as well as full-penetration groove welds are satisfactory in many applications involving static loading, and can produce joints matching the strength of the parent material.

Caution is required if materials are to be welded which rely on special heat treatment or cold working to impart strength or ductility, for example alloy steels and aluminum alloys. In these cases, the heat from welding locally disturbs the parent material and matching mechanical properties cannot be expected without further processing. Weld defects resulting from improper procedures may also impair joint properties.

Many design Codes, for instance the ASME Boiler and Pressure Vessel Code stipulate joint configurations, working stress levels and analytical procedures in detail, which the designer is obliged to follow. Such Codes may also require welding procedure and welder qualification tests to demonstrate acceptable weld mechanical properties and soundness before the procedures are used in production.

The table below gives allowable unit loads on steel fillet welds of various leg sizes for general purpose use. It is assumed that the welds are equal - leg fillets where the weld "throat", a better indication of weld shear strength, is equal to 0.707 of the leg length (see Figure 3). Usually a weld metal is chosen which matches the strength of the base material.

The strength of connections between structural members composed of groups of such fillet welds can be calculated by a method in which the welds are treated as lines arranged around the section outline. The geometric properties of the weld group, such as moments of inertia, are readily calculated or found from tables, and the problem becomes simply one of determining the force per unit length of weld.

Weld size, in.	Strength level of weld metal, ksi						
	60 <sup>a</sup>	70 <sup>a</sup>	80	90 <sup>a</sup>	100	110 <sup>a</sup>	120
	Allowable unit load, 10 <sup>3</sup> lb in.						
1/16	0.795	0.930	1.06	1.19	1.33	1.46	1.59
1/8	1.59	1.86	2.12	2.39	2.65	2.92	3.18
3/16	2.39	2.78	3.18	3.58	3.98	4.38	4.77
1/4	3.18	3.71	4.24	4.77	5.30	5.83	6.36
5/16	3.98	4.64	5.30	5.97	6.63	7.29	7.95
3/8	4.77	5.57	6.36	7.16	7.95	8.75	9.54
7/16	5.57	6.50	7.42	8.35	9.28	10.21	11.14
1/2	6.37	7.42	8.48	9.54	10.61	11.67	12.73
5/8	7.96	9.28	10.61	11.93	13.27	14.58	15.91
3/4	9.55	11.14	12.73	14.32	15.92	17.50	19.09
7/8	11.14	12.99	14.85	16.70	18.57	20.41	22.27
1	12.73	14.85	16.97	19.09	21.21	23.33	25.45

a. Fillet welds actually tested by the joint AISC-AWS Task Committee

Table 1: ALLOWABLE UNIT LOADS ON STEEL FILLET WELDS

The following example illustrates the steps in calculating the size of weld in the bracket to column connection shown below.

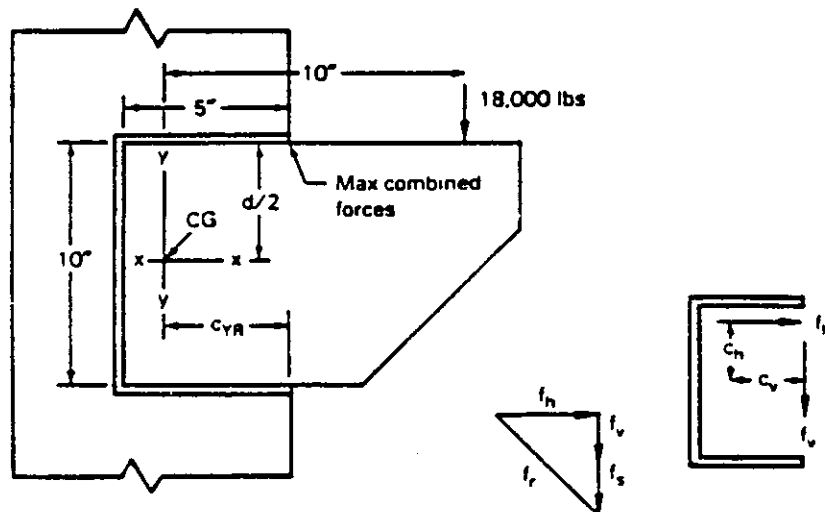

Figure 4: BRACKET JOINED TO A COLUMN FACE WITH A FILLET WELD

Step 1: Determine the centroid of the weld group. In this case  $C_{yr} = 3.75$  in (from tables).

Step 2: Determine the points where the resultant force per unit length is a maximum. The bending or torsional component is greatest at the point(s) furthest from the centroid (i.e., the right-hand ends of the horizontal fillet welds in this case) and to this is added the vertical shear, assumed to be uniformly distributed over the weld group.

Step 3: Determine the maximum resultant force/unit length.

The bending component is split into horizontal ( $f_h$ ) and vertical ( $f_v$ ) components.

The horizontal bending component is:

$$f_h = \frac{T d/2}{J_w}$$

where

T, applied torque	= 180,000 lb/in.
$J_w$ , polar moment of weld group	= 385.4 in <sup>3</sup>
d = section depth	= 5 in.

i.e.  $f_h = 2,340$  lb/in.

Similarly,

$$f_v = \frac{T C_{yr}}{J_w}$$

= 1,750 lb/in.

The vertical shear force,

$$f_s = \frac{P}{L_w}$$

where

$$P, \text{ shear force} = 18,000 \text{ lb}$$

$$l_w, \text{ weld length} = 20 \text{ in.}$$

i.e.

$$f_s = 900 \text{ lb/in.}$$

The resultant force per unit length is:

$$f = [f_h^2 + (f_v + f_s)^2]^{\frac{1}{2}}$$
$$= 3,540 \text{ lb/in.}$$

Step 4: Determine the weld size.

If the allowable stress on the effective area is 30% of the UTS, and a 60,000 psi UTS filler is used,

$$\tau = 0.3 \times 60,000 = 18,000 \text{ psi}$$

Weld effective throat required:

$$E = \frac{f}{\tau} = \frac{3,540}{18,000} = 0.197 \text{ in.}$$

Assuming an equal leg fillet, the fillet weld size

$$S = \frac{E}{0.707} = 0.279 \text{ in.}$$

In practice a 5/16 inch fillet weld would be specified.

## 2.5 Fatigue of Welded Structures

"Fatigue failure" of a structure means the gradual formation and propagation of a fracture under repeated or fluctuating loading.

Fatigue failure is one of the most common modes of failure of welded structures. The fatigue strength of welded structures depends on the detail design of the joints. Many well-conceived structures and pieces of equipment are spoiled by poor detail design and bad selection of joint types.

The reason why fatigue failures associated with welds are so common is because it is easy to introduce severe stress concentrations to a welded structure. A weld bead made across a plate creates an abrupt change of section and hence stress concentrations at the toes of the weld bead. If the plate is subjected to oscillating loads transverse to the weld, these stress concentrations tend to initiate fatigue cracks. A transverse butt weld can reduce the cyclic life by a factor of ten compared to the as-rolled plate. Features such as backing rings and weld undercut tend to reduce fatigue endurance further by creating more severe stress concentrations. The fatigue strength of plate butt welds is markedly improved by machining or grinding the surfaces flush after welding.

If transverse butt welds are sufficient to reduce fatigue strength, it can be anticipated that fillet welds and partial penetration welds, with their inherently severe stress concentrations, perform poorly under fatigue loading. Not only is this so, but the flexibility of fillet welds encourages their use to fit gussets, brackets, splice plates and other odd attachments that give rise to a general stress concentration in addition to localized effects near the welds. Beware of making minor fillet-welded attachments to members carrying cyclic loads with the lame excuse that the welds are "not strength welds". These non-strength welds may well be a feature that impair the fatigue life of the structure.

The approach that has been adopted for fatigue design of structures such as bridges is based on fatigue testing of typical welded details to enable the details to be put into different categories of cyclic life. By comparison with standard charts, the designer may determine the fatigue life of a structure from its lowest quality detail.

The ASME Boiler and Pressure Vessel Code gives other criteria for design of welded components subject to cyclic loading from plant operation. The ASME Code gives stress indices, reflecting the stress concentrations that occur at welds, which are used to factor the allowable working stresses in the joints. The ASME B&PV Code also tends to restrict the use of poor fatigue details such as fillet welds or permanent backing rings in many cases.

## 2.6 Brittle Fracture

Failure of welded structures by "brittle" or fast fracture is fortunately rare. However, the serious consequences of a catastrophic failure of large structures such as bridges, ships and pressure vessels - and the fact that such failures have occurred - justify the effort to understand and avoid them. Much of what is known about fast fracture stems from research begun in the 1940's after a number of welded ships literally broke in two - some while berthed in calm seas.

Materials can exhibit different modes of failure under different circumstances. Structural steels are normally expected to show a high level of ductility, which makes them excellent materials for many applications. Unfortunately structural steel, along with other materials, can fail in a brittle manner under certain conditions, resulting in the rapid propagation of a fracture.

The factors promoting fast fracture of a steel structure are:

### 1. Tensile Stress

2. Stress Concentration
3. Low Temperatures
4. Large Thicknesses
5. Material Microstructure

Welding contributes to these conditions in several ways -- in addition to the fact that welding makes possible the monolithic, highly stressed structures that are susceptible to brittle fracture in the first place!

Welding can add tensile residual stresses of yield point magnitude locally. Severe stress concentrations can be introduced by welds, both from the geometry of the surface and internal defects such as cracks. Welding may also locally alter the microstructure of the material to produce zones of poor ductility and toughness.

Several measures are adopted in codes such as the ASME Boiler and Pressure Code to ensure fracture-safe design of large components. Materials are tested by fracture mechanics techniques to ensure they possess adequate toughness at the test and service temperatures. Charpy notch impact tests are carried out on weld metal and heat affected zones in the weld procedure qualification test coupons. Welds in thicker sections are given heat treatment to relieve residual stresses. Surface and volumetric non destructive examinations are used to detect any weld defects that may exist.

## 2.7 Distortion

The intense heating and rapid cooling of welding cause metals to undergo localized expansions and contractions which result in permanent distortion of the workpiece.



Typical patterns of distortion in a single V-groove weld are illustrated below, Fig. 5. Transverse shrinkage in multi-pass groove welds can amount to 1/16 to 1/8 inch, depending on the number of passes. Longitudinal shrinkage can be of the order of 1/8 inch per 10 feet of weld.

Distortion is as much a design problem as a manufacturing one. Good design practice with respect to distortion is:

1. Ensure good joint fit-up.
2. Design to keep the length of weld seams and the size of weld deposits to a minimum.
3. Balance welds about the neutral axis of a section to prevent bowing.
4. Avoid welding as a means of assembling finished machined parts to precise dimensions. Weld, then finish machine.

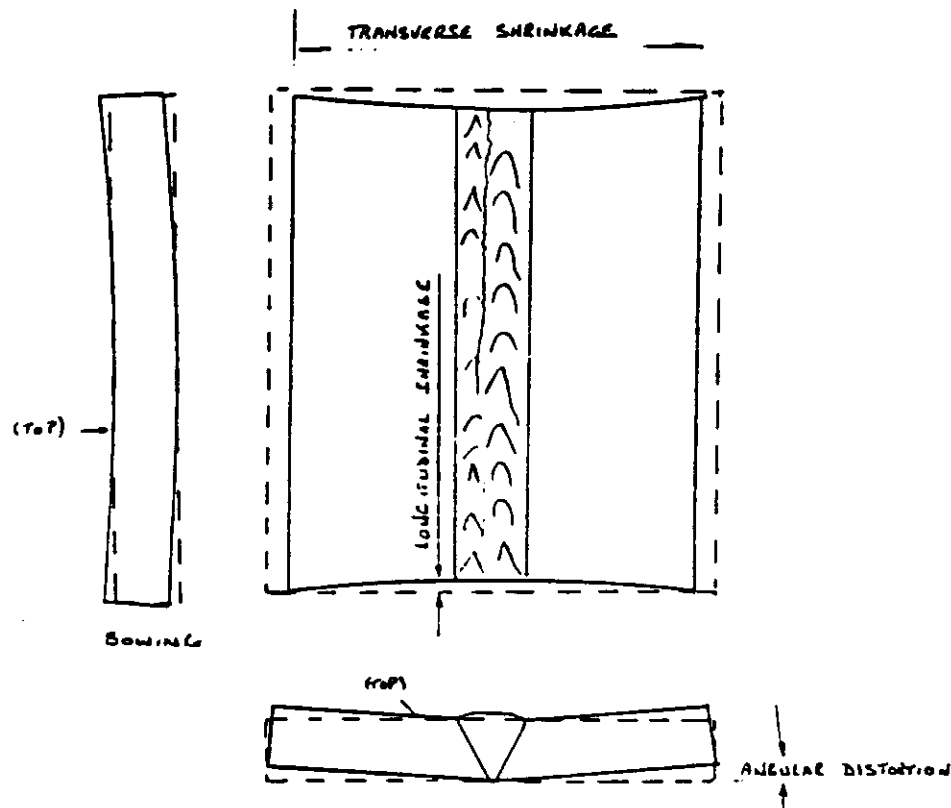

Figure 5: TYPICAL V-GROOVE WELD DISTORTION PATTERNS

### 3.0 WELDING PROCESSES

Theoretically, an ideal weld might be formed by bringing together ultra-clean, precisely matching metal surfaces so as to enable atoms to share electrons across the interface. Although this ideal is rarely achieved, there are many practical ways of making satisfactory welds.

The welding processes most used for structural work are termed "fusion welding processes", because coalescence of the materials is arranged by melting, or fusing, them. The heat required to locally melt the material in many fusion welding processes is supplied by an electric arc maintained between a welding electrode and the workpiece. The heat for melting can be provided in other ways also. Oxy-acetylene flames, laser and electron beams are examples of non-arc heat sources.

As well as a heat source, a method is often needed for preventing metal from reacting with the surrounding atmosphere. Fluxes and slags, blanketing the weld zone with inert gas, or working in-vacuum are techniques used to avoid atmospheric contamination.

The great variety of welding processes is an indication of the many ways in which heating sources and atmospheric shielding can be provided. In fact, much of the skill of the welding engineer lies in recognizing the essential requirements for a joint and choosing an appropriate process.

The fusion welding processes described below account for probably 90% of all structural welding performed, although several economically - important process have been omitted. Sources of further information on processes are indicated at the end of the handbook.

### 3.1 Oxyfuel Gas Welding (OFW)

The gas used for fuel is selected for its heat output when mixed with oxygen. Most gas welding is done with oxygen and acetylene gases. It is normally referred to as oxy-acetylene welding. The hottest flame produced by any of the oxygen-fuel mixtures is oxy-acetylene. For example, oxy-acetylene is used for metals having relatively high melting points. These include the carbon steels, cast irons, stainless steels, copper and copper alloys.

Other fuel gases, having lower flame temperatures, may be used for metals and alloys which have relatively low melting points. For example, hydrogen, natural gas and several manufactured gases are separately combined with oxygen for welding aluminum, magnesium, lead, zinc and some precious metals. Cost difference may influence choice.

The three basic flames used for oxy-acetylene gas welding are illustrated in Figure 6. Each flame type has its specific use with various metals and alloys. For example, a carburizing flame is normally used when welding aluminum, a neutral flame when welding carbon steels, and an oxidizing flame is used for brazing with bronze alloys.

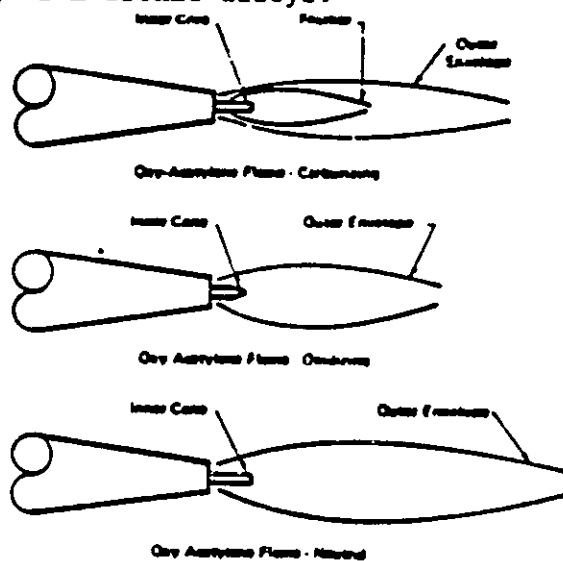

Figure 6: TYPICAL OXY-ACETYLENE FLAMES

## Fluxes for Oxy-fuel Gas Welding

An important factor in weld quality is the removal of surface oxides from the molten weld pool and adjacent areas. Unless the oxides are removed, fusion may be difficult and oxides may become entrapped in the solidifying metal. These conditions occur particularly when the oxides have a higher melting point than the base metal, and a means must be found to remove these oxides. Fluxes are applied for this purpose.

Fluxes for oxy-fuel gas welding are available as proprietary mixtures. The fluxes generally contain mineral oxides, fluorides, and borates with small quantities of organic binders and wetting agents. These substances react chemically with the oxides of most metals to form molten slags at welding temperatures. The slag protects the weld region from the atmosphere and from the gases in the flame.

The flux may be prepared as a dry powder, a water-mixed paste, or as a coating on the filler rod. Dry powder fluxes are applied by dipping the heated end of the filler rod into the powder. Enough adheres to the rod for adequate fluxing. Fluxes in paste form are usually painted on the base metal with a brush and the welding rod may be either painted or dipped.

The common metals and welding rods requiring the use of fluxes are bronze, cast iron, silicon bronze, stainless steel, nickel alloys, and aluminum. Carbon steel can be welded without fluxes.

Equipment for Oxy-fuel Gas Welding

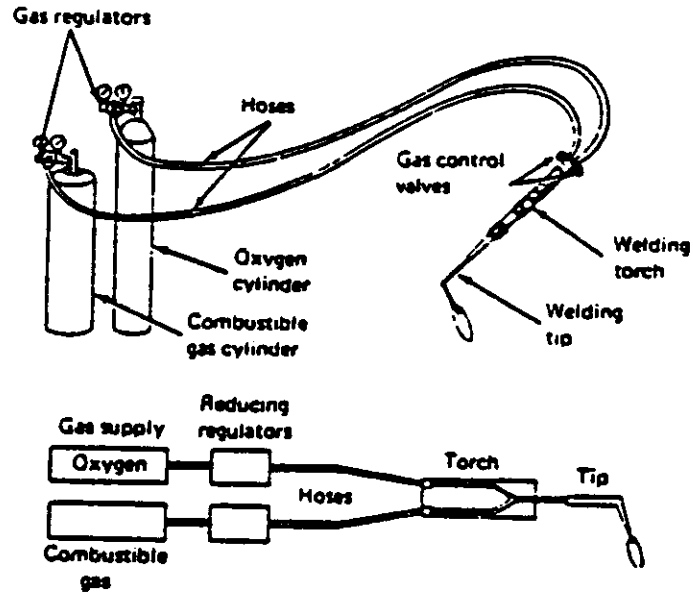

Figure 7(a): BASIC EQUIPMENT FOR OXY-FUEL GAS WELDING

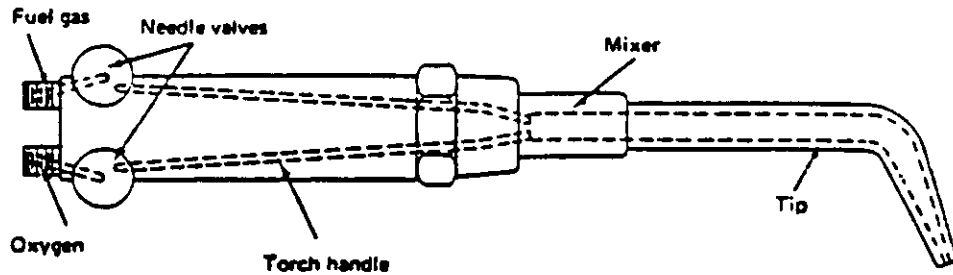

Figure (7(b)): ELEMENTS OF AN OXY-FUEL GAS WELDING TORCH

The minimum basic equipment needed for perform oxy-fuel gas welding is shown schematically in Figure 7. This equipment setup is completely self-sufficient and relatively low in cost. It consists of fuel gas and oxygen cylinders, each with pressure regulators, hoses for conveying the gases to the torch, and a torch and tip combination for adjusting the gas mixtures and producing the desired flame. The same basic equipment is used for torch brazing and heating operations. By simple substitution of the proper torch and tip combinations, the equipment is readily available for manual and carriage-controlled oxygen cutting.

Pressurized oxygen and fuel gases are safe when used with the proper, well-maintained equipment, but present a serious fire or explosion hazard if handled improperly. Operators should be familiar with the capabilities and limitations of the equipment and the rules of safe operation, including those contained in American National Standard Z49.1, 'Safety in Welding and Cutting', published by the American Welding Society.

#### Applications of Oxy-Fuel Gas Welding

Low carbon, low alloy, and cast steels are most easily welded by the oxy-acetylene process. Stainless steels require the use of fluxes to remove oxides. Cast irons are difficult to weld by any method. However, repairs can be made to cast iron components by oxy-acetylene welding if suitable procedures are employed. Aluminum, brasses, and bronzes can be joined. Oxy-acetylene welding should not be used for reactive metals such as titanium or zirconium.

The process may be used for fabricating sheet metal, tubing or piping in relatively thin sections. Because of the low equipment cost and the flexibility of the process, it is widely used for light fabrication or maintenance operations in the small industrial, agricultural, and automotive industries. Oxy-acetylene welding is generally unsuited to the quality requirements for nuclear power stations.

### 3.2 Shielded Metal Arc Welding - SMAW - (Stick Welding)

Shielded metal arc welding (SMAW) or manual metal arc welding with stick electrodes is one of the most commonly used welding processes for structural work, since it provides freedom of design and high-quality welds in a range of section thicknesses with a minimum equipment cost.

The electrode consists of a core wire surrounded by a uniform extruded flux covering, as illustrated in Figure 8. In operation, the arc is struck between the end of the electrode and the base metal. The core wire progressively melts and is carried across the arc in droplet form into the weld pool. The flux is melted with the core wire, forming a slag which performs the following principal functions:

- promotes electrical conduction across the arc
- protects the molten metal from atmospheric contamination
- modifies the alloy content of the weld metal
- controls the bead shape.

The flux covering has a major influence on the handling characteristics of the electrode and the quality of the weld deposit. 'Handling characteristics' means the ease of use, the ability to weld in positions other than the flat position, and whether the electrode will run on AC, DC electrode negative, or DC electrode positive. A variety of electrode types are in common use for different applications: see, for example, the American Welding Society A5.1 'Specification for carbon steel covered electrodes'. EXX18 is a grade frequently used in structural steel and pressure vessel work. According to the AWS classification, the first two digits give the minimum UTS of the weld metal in kips and the last two digits denote the handling characteristics. The flux coating in this case is composed mainly of calcium oxide (lime) and calcium fluoride (fluorspar) with small amounts of potassium salts to enhance arc stability on AC. About

30% iron powder is added to the coating to increase the deposition rate. EXX18 is a versatile electrode that can be used in all positions to make high-quality welded joints.

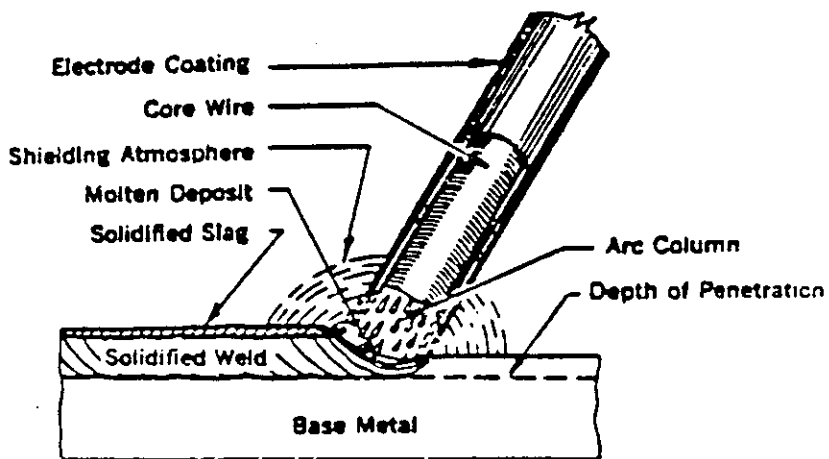

Figure 8: SHIELDED METAL ARC WELDING



Some coated arc welding electrodes are designed for use only with direct current, either DC electrode negative (DCEN), also known as straight polarity, or DC electrode positive (DCEP), also called reverse polarity. Others are designed specifically for alternating current although these will usually work on DC. The type of current and polarity used should generally follow the recommendations of the electrode manufacturer.

Manual metal arc welding requires experienced welding operators. Simple welding operations may be taught in a few weeks, but an operator capable of making satisfactory welds in all positions, on a variety of metals, is a highly skilled artisan usually of long experience. Equipment is very portable, for use in the shop or in the field.

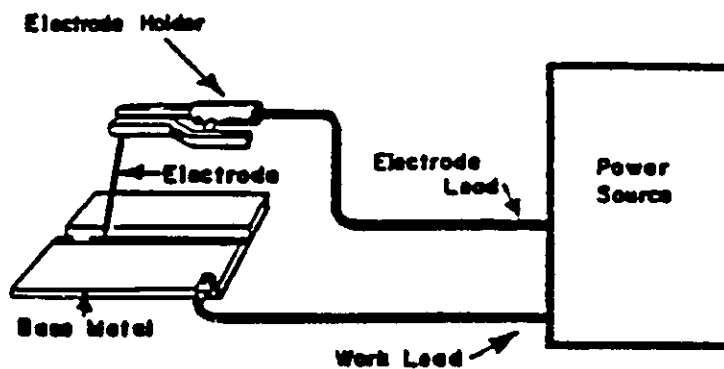

Figure 9: ELECTRIC CIRCUIT FOR SMAW

### 3.3 Submerged Arc Welding (SAW)

In submerged arc welding (SAW), a continuous wire electrode is fed into a mound of granular flux that covers the joint. The welding head is traversed mechanically along the joint and flux is added continuously, as illustrated in Figure 10. The arc causes the base metal, electrode, and

flux in the immediately vicinity to melt. The melted base material and filler flow together in the joint. At the same time, the melted flux floats on the surface, forming a protective slag. Since the arc runs beneath the flux covering without sparks, smoke, or flash, the operator needs little protective equipment. Unmelted excess flux can be reclaimed.

Originally developed for fully automatic operation, SAW is widely used for heavy structural fabrication such as plate girder production, pressure vessel manufacture, and shipbuilding. Submerged arc can produce high-quality multi-pass welds in substantial section thicknesses. There are several variations of the process, designed to permit higher deposition rates. Various multiple electrode systems, such as twin wires in tandem, that use one or more power sources with different types of electrical connection are available. Also available is a semi-automatic version with a hand-held torch. Due to the high deposition rates that can be achieved, SAW offers excellent productivity and a low cost per pound of deposited metal. One disadvantage of the process is that it can be used only in the flat or horizontal fillet positions. Mechanical manipulators are commonly used to position the workpiece for welding.

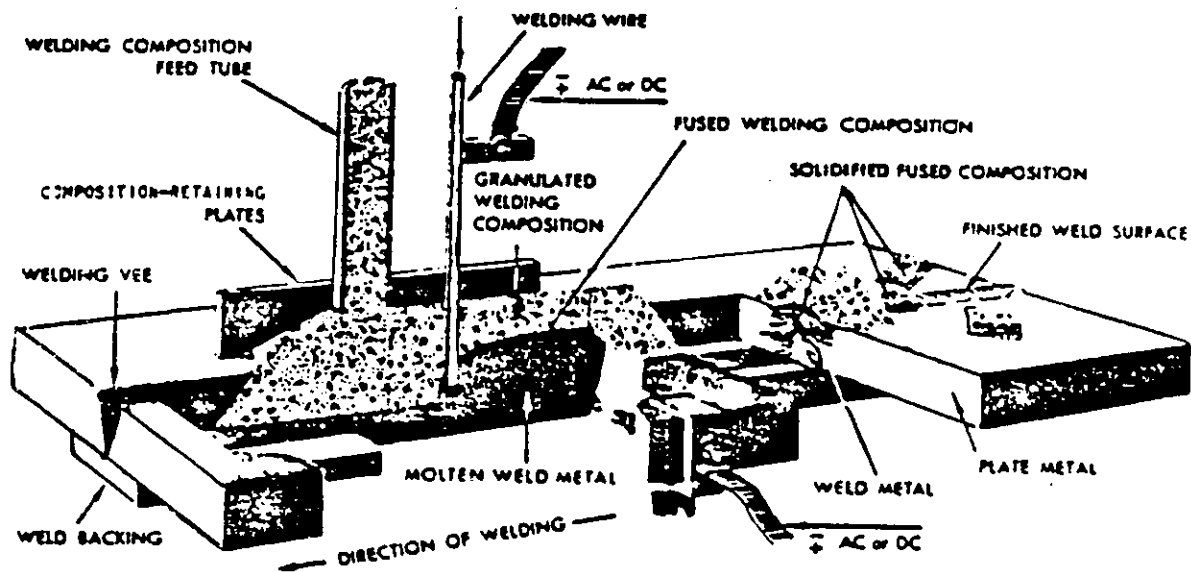

Figure 10: SUBMERGED ARC WELDING PROCESS

Recommended Currents and Deposition rates

The tables below indicate typical current ranges for each particular electrode size.

<u>Approximate Deposition Rates</u>	
Single Wire	- 20-30 lbs/hr
Twin Wire	- 60 lbs/hr
Triple Wire	- 100 lbs/hr

Wire Diameter (ins)	Current (amp)
5/64	200 - 650
3/32	230 - 650
1/8	300 - 900
5/32	420 - 1000
3/16	480 - 1100
7/32	600 - 1200
1/4	700 - 1600
5/16	1000 - 2500
3/8	1500 - 4000

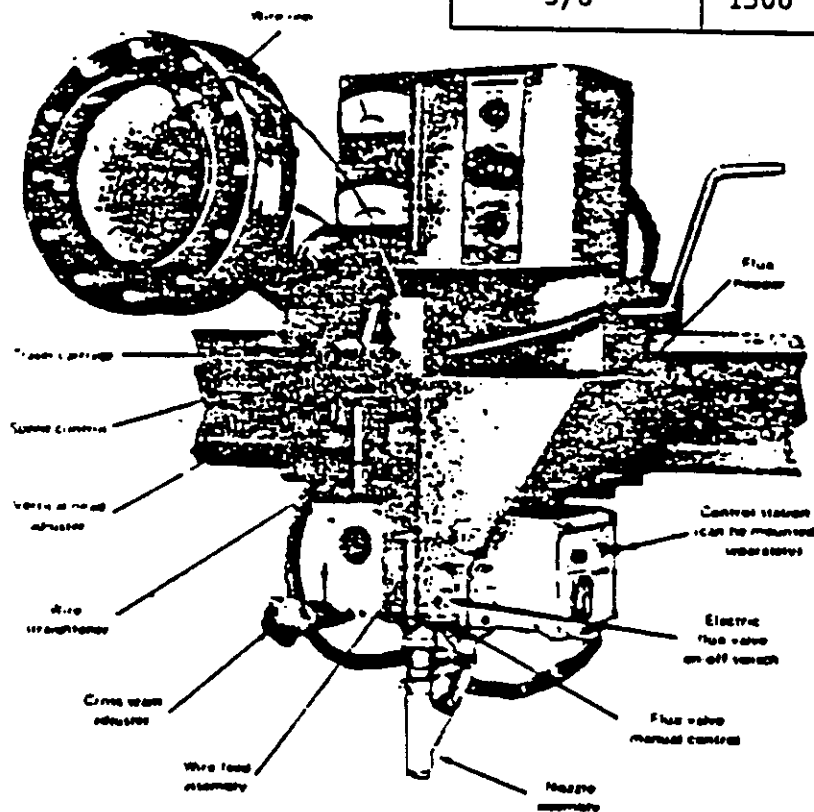

Figure 11: TYPICAL SUBMERGED-ARC WELDING HEAD

### 3.4 Gas Tungsten Arc Welding (GTAW) - TIG, Heliarc

In gas tungsten arc welding (GTAW), an arc is maintained between a non-consumed tungsten alloy electrode and the workpiece, as indicated in Figure 12. Shielding gas flows through a nozzle which surrounds the electrode, protecting the heated weld zone from atmospheric contamination. The shielding gas is usually argon or helium, although mixtures of argon with up to 10% hydrogen are sometimes used for welding stainless steels, and nitrogen may be used for welding copper. Filler is added separately when required for metallurgical reasons or to provide weld reinforcements. Many metals can be welded without the addition of filler, given suitable joint preparations.

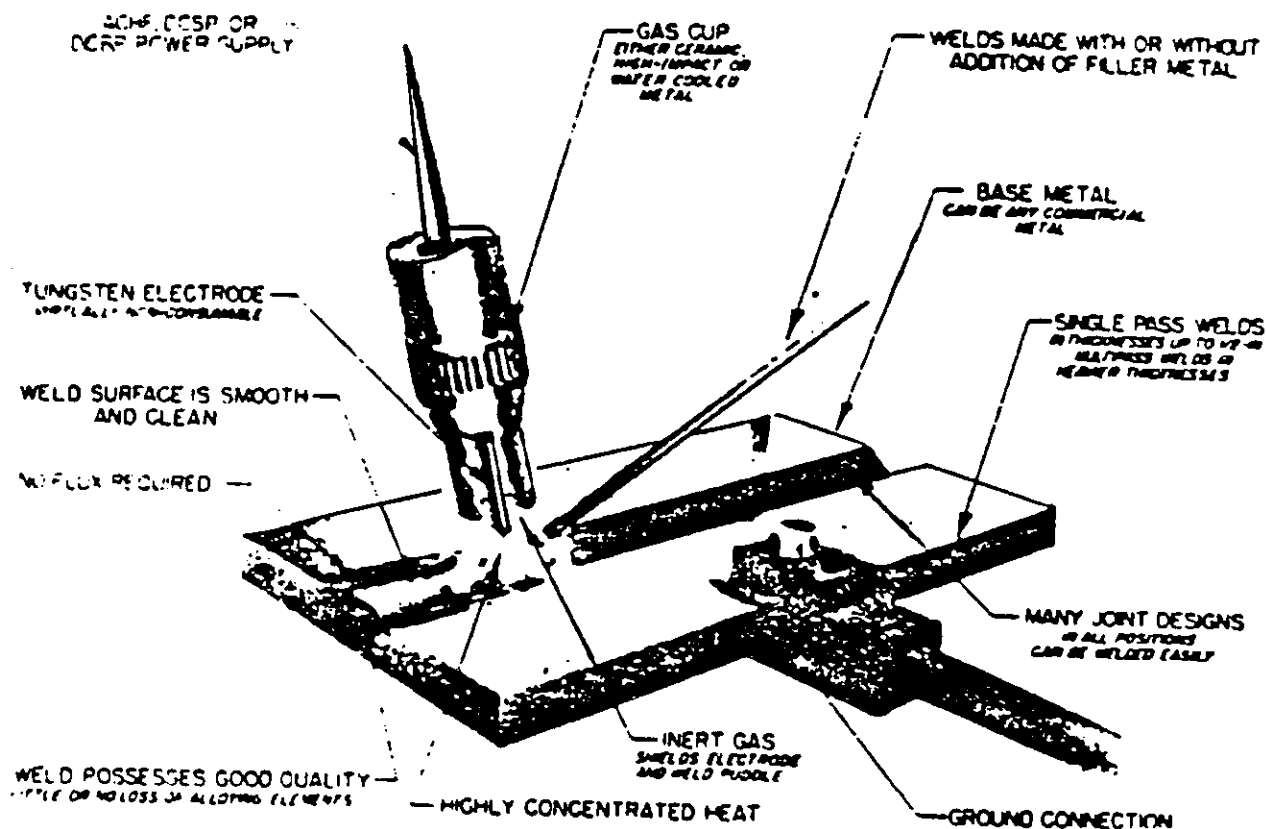

Figure 12: GAS TUNGSTEN ARC WELDING

## GTAW Process Operation

The arc converts electrical energy into heat. Most of the heat is generated at the surfaces of the electrode and workpiece by the emission and absorption of electrons and ions. The positive terminal or anode receives about 60% of the energy dissipated in the arc and the negative terminal or cathode about 30%. The electrically-conducting ionised gas that fills the space between the cathode and the anode, although at very high temperature (10,000°C), makes little direct contribution to heating of the workpiece. Thus arc heating differs from heat transfer from an ordinary flame.

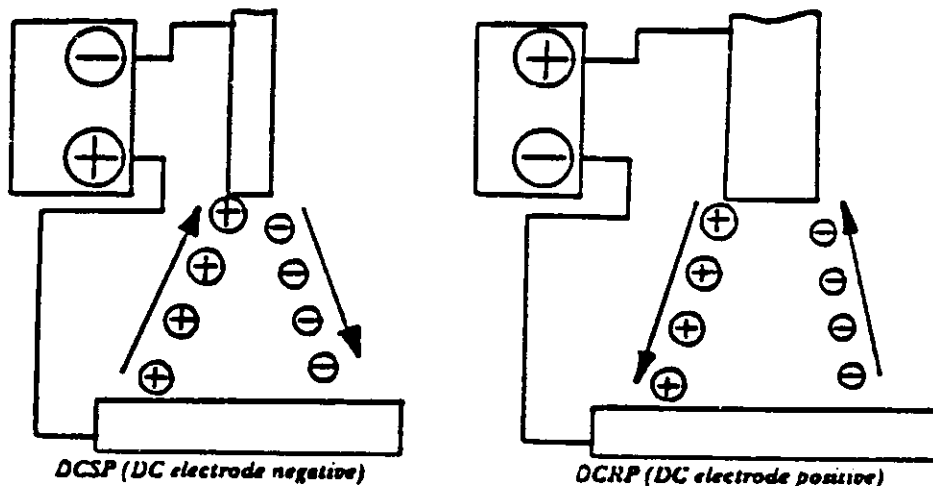

Figure 13: ELECTRON (-) AND ION (+) FLOW IN THE GTAW ARC

GTAW is usually operated on DC with the electrode connected to the negative terminal of the power supply and the workpiece to the positive terminal. This polarity produces the greatest heat input to the workpiece. The opposite polarity is sometimes used for welding aluminum or magnesium alloys because it is found to cause removal of the tenacious oxides that form on the surfaces of these metals. However, electrode positive polarity results in most of the heat being generated at the tungsten electrode, limiting its current carrying capacity. The bead size that can be produced with DC

electrode positive is thus restricted. AC provides a useful compromise between oxide removal and heat input for welding aluminum or magnesium.



DC Electrode negative -- deep penetration narrow weld



DC Electrode positive -- shallow wide weld

Figure 14: TYPICAL WELD PENETRATION OBTAINED WITH GTAW DC ELECTRODE NEGATIVE (DCEN) AND DC ELECTRODE POSITIVE (DCEP)

On AC operation, a high voltage must be available to reignite the arc each time the current passes through zero. This is commonly accomplished using special power supplies having either a square output waveform or a high frequency, high voltage generator. Independent of arc reignition, a phenomenon known as 'inherent rectification' may occur on AC operation due to the semiconducting nature of metal oxides. This results in a DC current component which tends to saturate power supply transformers, making it necessary to derate them to about 70% of their usual value. If considered detrimental, these effects can be corrected by inserting a large capacitor in the power circuit.

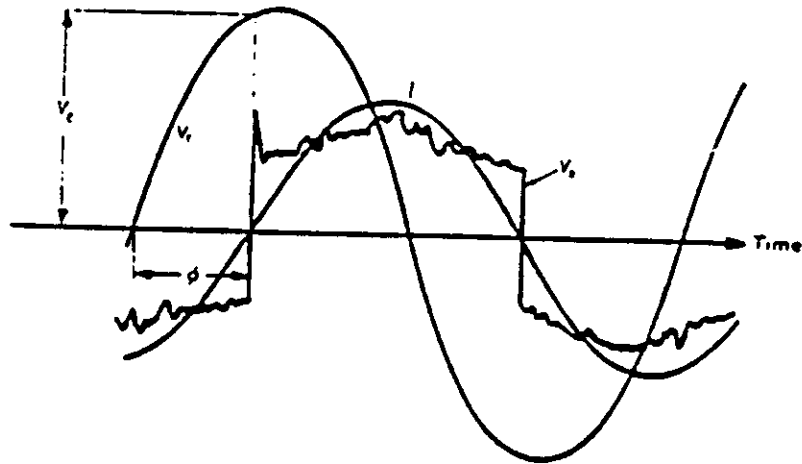

Figure 15: VOLTAGE AND CURRENT WAVEFORMS FOR AN A.C. WELDING ARC  
 $V_t$ , no load voltage of transformer;  $V_a$ , arc voltage;  
 $V_g$ , voltage across arc gap on reversal.

Automated GTAW is often used to make welds in small tubes and sheet metal. In such cases, it is important to control the weld bead shape and depth of penetration. The fused cross-section obviously depends on the arc energy. A number of other variables also affect bead shape, however, including: arc length, shielding gas composition, and electrode tip geometry. Another, elusive variable is the effect on fused zone shape of minor differences in base material composition. These effects tend to make precise control of weld penetration more difficult, even using relatively sophisticated machines. Several measures may be taken to improve control of weld penetration. Pulsing the current between a 'peak' and 'background' level at frequencies in the range 1 to 10 Hz has some beneficial effects on control of penetration and is commonly included on GTAW power supplies. Heat sinks placed beside the weld can aid control of penetration. Feedback systems for controlling weld temperature have been developed for some applications. Perhaps, however, it is best to avoid the need for precise weld bead shapes when possible.

## GTAW Materials and Applications

Gas tungsten arc can be used to join a number of metals for which no satisfactory flux-shielded processes exist. GTAW can make high-quality welds in carbon and stainless steels, nickel alloys, aluminum, copper, titanium, and zirconium alloys. The major process applications are the manufacture of components in these materials for the nuclear, aerospace, and chemical industries.

For the most basic applications, the torch and filler are manipulated manually. Equipment for manual GTAW is comparatively simple. The power supply would include a HF generator for arc starting, a foot rheostat for fine current control, and possibly the means for current pulsing.

In GTAW, the travel speed, current, arc length, and filler wire feed rate may be varied independently over wide ranges. Consequently, GTAW is flexible and easy to apply in mechanised form. Machines for tube, pipe, and tube-to-tubesheet welding are available commercially. The equipment typically comprises a mechanised torch carriage and a power supply which incorporates controls for welding current, carriage speed, wire feed rate, and gas flow levels, with timers to control the process sequence. Some form of seam tracking mechanism may also be included. One-axis seam tracking systems based on sensing the voltage drop across the arc are very useful for pipe welding because they eliminate the need to align the welding fixture exactly concentric with the pipe and can cope with weld build-up in multi-pass welds.

The greatest disadvantage of the GTAW process is the low deposition rate and hence the low productivity. Two process variants have been developed to improve productivity. In hot-wire GTAW, AC is passed through the filler from a separate power supply, preheating the wire before it enters the weld pool, Figure 16(a). In the flat position, the filler can be deposited up to



five times faster than conventional GTAW. Alternatively, productivity can be improved by reducing the area of the weld preparation and hence the volume of metal that must be deposited. So called 'Narrow-Gap' GTAW has been employed for joining thick pipes. This process requires special arrangements for supplying shielding gas to the bottom of the groove and close control of the process variables in order to ensure adequate sidewall fusion (Figure 16(b)).

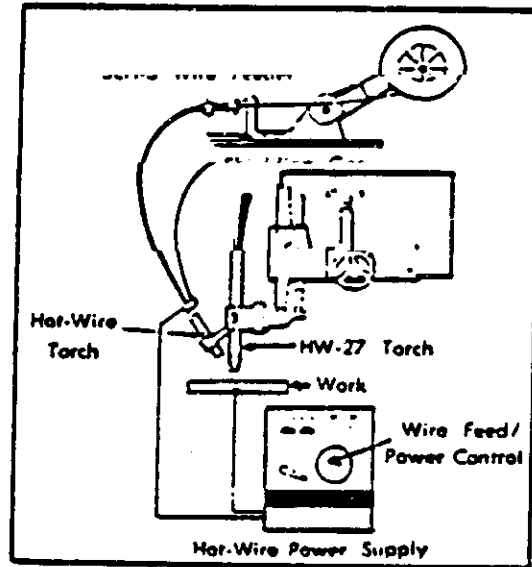

Figure 16(a): HOT WIRE GTAW EQUIPMENT

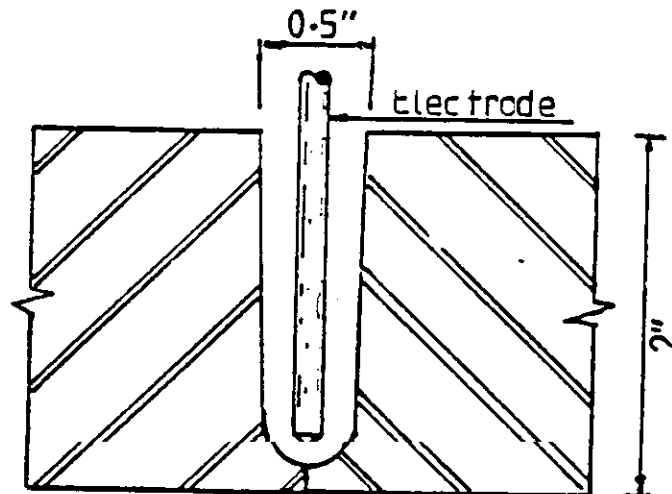

Figure 16(b): TYPICAL NARROW GAP WELD PREPARATION

### 3.5 Gas Metal Arc Welding (GMAW)-MIG/MAG, AIRCOMATIC

In gas metal arc welding (GMAW), a continuous wire electrode is fed mechanically through a welding torch which also provides gas shielding for the weld zone, as indicated in Figure 17. An arc is maintained between the end of the wire and the workpiece. GMAW is used invariably with DC and usually with the electrode positive. The shielding gas may be argon, argon-oxygen, argon-hydrogen, argon-carbon dioxide, carbon dioxide, or one of several proprietary mixtures, depending on the metal being welded and the welding procedure.

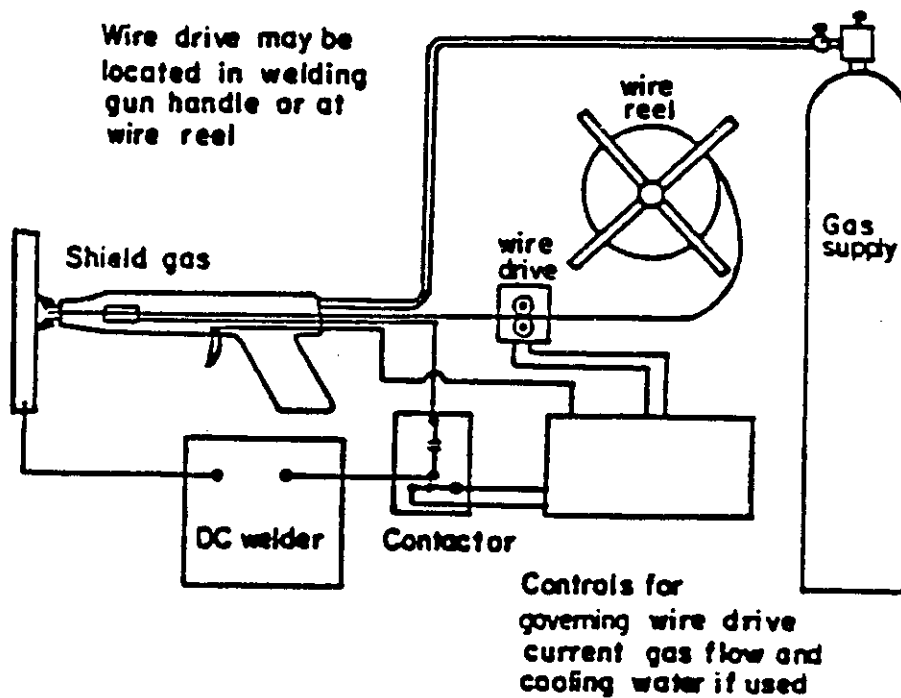

Figure 17: SCHEMATIC DIAGRAM OF GAS METAL ARC WELDING PROCESS

The form of metal transfer across the arc depends on a number of variables, such as current, voltage, wire diameter and feed rate, shielding gas, and the power supply electrical characteristics. Three modes of metal transfer are used:

- a) Spray or droplet transfer: Above a transition current and voltage for a given wire diameter and feed rate, small droplets are detached from the end of the wire and propelled across the arc by electromagnetic forces. A constant arc length is maintained by variable speed wire drive rolls reacting to changes in the arc voltage. Alternatively, power sources with a flat static output characteristic can be used which provide a large change in current and hence burn-off rate for a given change in arc voltage. The latter is more convenient for manually-held torches where the wire is fed at constant speed through a long, flexible conduit.

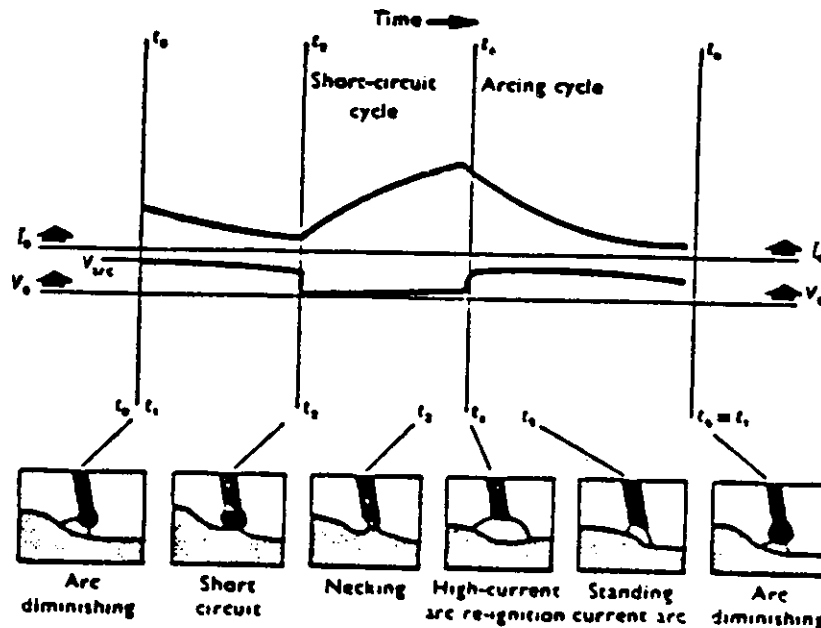

Figure 18: THE SHORT-CIRCUIT OR DIP-TRANSFER PROCESS Upper: typical voltage and current records; below: appearance of process from high-speed cine record.

- b) Short-circuiting or dip transfer: At lower voltages, arc length is reduced so that drops contact the workpiece before detaching from the wire, thus forming a short circuit. The short circuit results in a rapid rise in current, which fuses the metallic bridge and

re-establishes the arc. Under certain narrowly defined conditions, a stable cyclic short-circuiting process takes place, as illustrated in Figure 18. For this process to operate, a flat power source characteristic is required, with an adjustable dynamic response. For a given metal-shielding gas combination, there is an optimum set of operating conditions for each diameter of electrode wire. The advantages of the short-circuiting process are the ability to weld in all positions and the ability to weld thin-gauge materials due to the low heat input.

- c) Pulsed or synergic transfer: At intermediate currents, an erratic, globular form of metal transfer takes place. Pulsing the current can induce regular droplet detachment. This recent process development permits a wider range of operating conditions and the ability to weld out of position.

Gas metal arc welding can be used to join a variety of metals including carbon and low alloy steels, nickel alloys, aluminum, magnesium, coppers and bronze. The process is relatively new, being developed in the 1960's, and has enjoyed a rapid growth in application, particularly in the manual, semi-automatic form, because of the high productivity that can be achieved compared to SMAW. Typical applications include automotive assembly, shipbuilding, earthmoving equipment, and structural steelwork. The process is readily converted to fully mechanized operation. In this form it is used, for instance, to apply corrosion resistant cladding to components for the nuclear industry and for joining sections of oil pipelines. Because of the complexity of the process, properly maintained equipment and an investment in procedure development are necessary to realize the full economic benefits, however.

### Advantages of GMAW

A summary of its advantages includes:

- a) High deposition rate;
- b) Greater percentage of arc time since electrode changing is eliminated;
- c) A more economical use of filler metal since there is virtually no stub loss;
- d) A potential for high-quality weld metal.

### 3.6 Flux Cored Arc Welding (FCAW)

This process is very similar to the gas metal arc process previously described, but, rather than using a solid wire, a hollow wire containing various fluxing or alloying ingredients is used. It is a consumable electrode process in that an arc is struck between the electrode and the workpiece causing the electrode (and flux ingredients) to melt. The electrode wire is continuously fed into the arc from a coil.

There are two main variations of the process, one using an external shielding gas and the other self-shielding. In the latter, gases are generated from the flux and special ingredients are included to reduce contamination of the weld metal by oxygen and nitrogen. The principal of operation of the two versions are shown in Figs. 19 and 20.

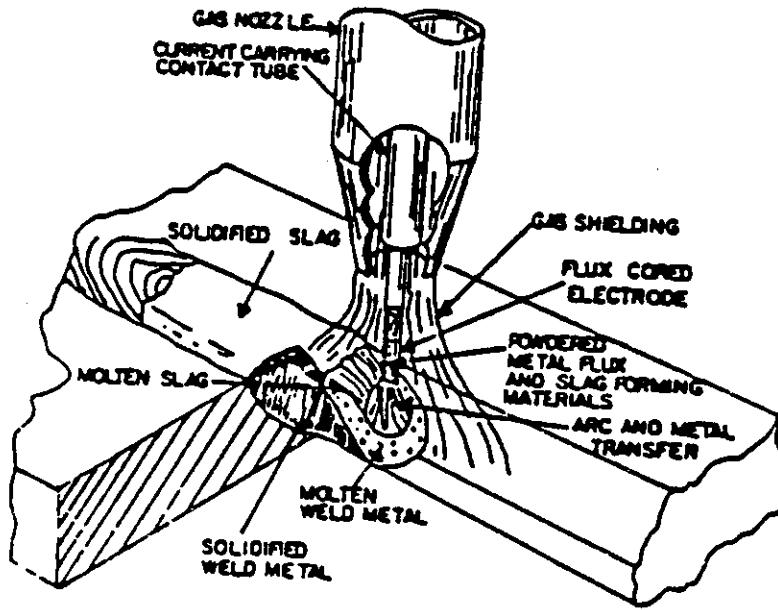

Figure 19(a): GAS SHIELDED FLUX CORED ARC WELDING

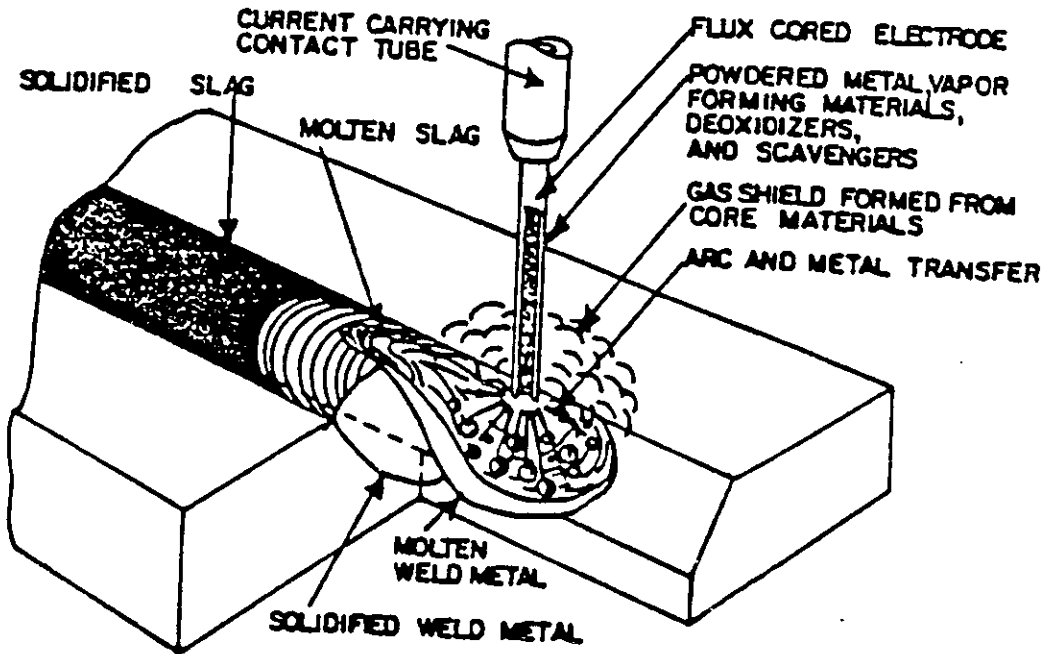

Figure 19(b): SELF-SHIELDED FLUX CORED ARC WELDING

The gun can be mounted on a carriage as a fully mechanized process, or used in the semi-automatic mode in which the gun is hand held and manipulated by the welder. In this way the process retains the flexibility of shielded metal arc welding, but has the advantage of a high duty cycle and high deposition rate. The flux cored process can produce high quality welds and is being used increasingly on steel fabrication in the medium thickness range.

#### Types of Wire Construction

A wide range of tubular flux cored wires are available and several types wire construction have been used. Some examples are shown in Fig. 20.

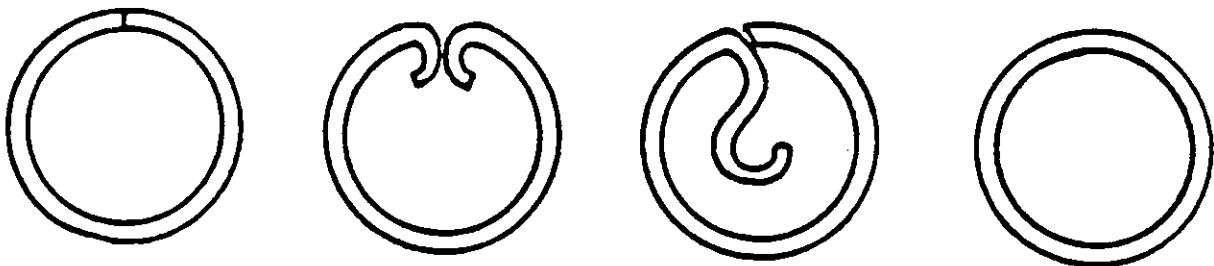

Figure 20: CROSS SECTIONS OF VARIOUS TYPES OF CORED WIRES

#### Gases

The most common gas used with flux cored welding is carbon dioxide ( $\text{CO}_2$ ) at a typical rate of 35 cu.ft/hr (16.5 L/min.). High penetration is achieved with this gas, and steel up to 1/2 in. (13 mm) thick may be welded without an edge preparation. With  $\text{CO}_2$ , the transfer of metal is usually globular.

Because of the oxidizing nature of CO<sub>2</sub> gas shield, the wire contains various deoxidizing elements (usually silicon and manganese), which react with the oxygen in the weld metal and prevent porosity. Gas mixtures may be used, and a 75% argon, 25% CO<sub>2</sub> mixture is popular and often preferred for welding out of position. CO<sub>2</sub> gas is about less expensive than argon or helium.

With the self shielding system, no external gases are required and all of the necessary shielding, deoxidation and denitrifying comes from ingredients in the core of the wire. This makes the equipment simpler and also makes the process more tolerant to wind which could disturb an external gas shield in an outdoor application.

### Materials

The flux cored process is used primarily for welding steels including structural grades, pressure vessel grades, alloy steels and some stainless steels. It is also used on cast iron and can be used for hard surfacing, overlaying and repair build-up.

### Electrodes

Specifications for flux cored tubular wires are covered in AWS 5.20 and CAS W48.5. There are differences between the American and Canadian specifications which should be noted.

Flux cored wires have the designation "T", meaning tubular and several types are specified covering both gas shielded and self-shielded types. Most gas shielded wires are operated electrode positive, but some (including some self-shielded wires) are operated electrode negative.



### Welding Parameters

Voltage can have an important effect on the bead shape. A high voltage leads to a wide bead and may give excessive spatter, while too low a voltage will reduce penetration and give a convex bead. In the self shielding system incorrect voltage may also lead to increased pick up of nitrogen from the air.

#### 4.0 WELDMENT QUALITY

Quality is a relative term. In engineering usage, an item has the right quality if it performs satisfactorily through its life -- in other words, if it has "fitness-for-purpose".

The selection of a particular quality level for an item is a judicious balance of design, manufacture and inspection which will achieve fitness-for-purpose at the lowest total cost over the full life of the structure. Quality levels can be permitted to vary among different weldments, depending on the service required. Specifying needlessly high quality levels can add substantially to the cost of a fabrication with no benefit. On the other hand, if quality is insufficient, failures may result in excess costs of lost service and high maintenance, if not worse. It should be realized that the lowest fabrication costs may not correspond with the lowest total cost over the life of a product.

Selection of a quality level for fitness-for-purpose involves design consideration of the following main factors:

1. Service Conditions: Stress levels, whether the loading is static or dynamic in nature, working temperatures, corrosion and wear.
2. Material Properties: Materials of suitable strength, toughness, corrosion resistance and other relevant properties must be selected. Also, any detrimental effects of welding and fabrication on materials must be considered.
3. Risk of Defects Arising: Welding procedures can produce defects of various types.
4. Risk of Defects Not Being Detected: Inadequate inspection or inaccessible geometry can result in defects being missed. There is a

finite risk that some defects will go undetected even by properly-applied inspection processes.

5. The Consequences of Failure: The consequences of structural failure tend to increase with:

- (i) Size of structure
- (ii) Stored energy (pressure vessels, towers, etc.)
- (iii) Location with respect to people
- (iv) Loss of production (a simple boiler tube failure may require little repair effort, but production loss is costly).

Fortunately, valuable guidance is provided by the many codes and standards which govern welded fabrication and define the quality requirements for reasonably safe operation of structures of various types. These codes and standards often indicate component designs, allowable stress levels, material properties, inspection and acceptance standards for weld discontinuities which have been proven through long experience.

#### 4.1 Fusion Weld Discontinuities

Fusion weld discontinuities are interruptions of the typical structure of a weldment such as a lack of homogeneity in the mechanical, metallurgical, or physical characteristics of the material or weldment. Discontinuities which exceed recognized acceptance standards are termed "defects", a word which signifies rejectability.

Fusion weld discontinuities may be classified into three major groups: namely process and procedures related, metallurgical and design related. Some discontinuities are related to specific welding processes, while others are related to particular base or filler metals. Discontinuities may be found in the weld metal, the heat affected zone and the base metal. The common weld discontinuities are listed in the table below and are depicted schematically in Figure 21.

COMMON TYPES OF FUSION WELD DISCONTINUITIES

Type of discontinuity	Depiction on Figs. 21	Location <sup>a</sup>	Remarks
Porosity		W	Weld only, as discussed herein
Uniformly Scattered	1a		
Cluster	1b		
Linear	1c		
Piping	1d		
Inclusions		W	
Slag	2a		
Tungsten	2b		
Incomplete fusion	3	W	At joint boundaries or between passes
Inadequate joint penetration	4	W	Root of weld preparation
Undercut	5	BM	Junction of weld and base metal at surface
Underfill	6	W	Outer surface of joint preparation
Overlap	7	W	Junction of weld and base metal at surface
Laminations	8	BM	Base metal, generally near mid-thickness of section
Delamination	9	BM	Base metal, generally near mid-thickness of section
Seams and laps	10	BM	Base metal surface almost always longitudinal
Lamellar tears	11	BM	Base metal, near weld HAZ
Cracks (includes hot cracks and cold cracks)			
Longitudinal	12a	W, HAZ	Weld or base metal adjacent to weld fusion boundary

COMMON TYPES OF FUSION WELD DISCONTINUITIES (Cont'd.)

Type of discontinuity	Depiction on Figs. 21	Location <sup>a</sup>	Remarks
Transverse	12b	W,HAZ,BM	Weld (may propagate into HAZ and base metal)
Crater	12c	W	Weld, at point where arc is terminated
Throat	12d	W	Weld axis
Toe	12e	HAZ	Junction between face of weld and base metal
Root	12f	W	Weld metal, at root
Underbead and heat-affected zone	12g	HAZ	Base metal, in HAZ
Fissures		W	Weld metal

W-weld, BM-base metal, HAZ-heat-affected zone

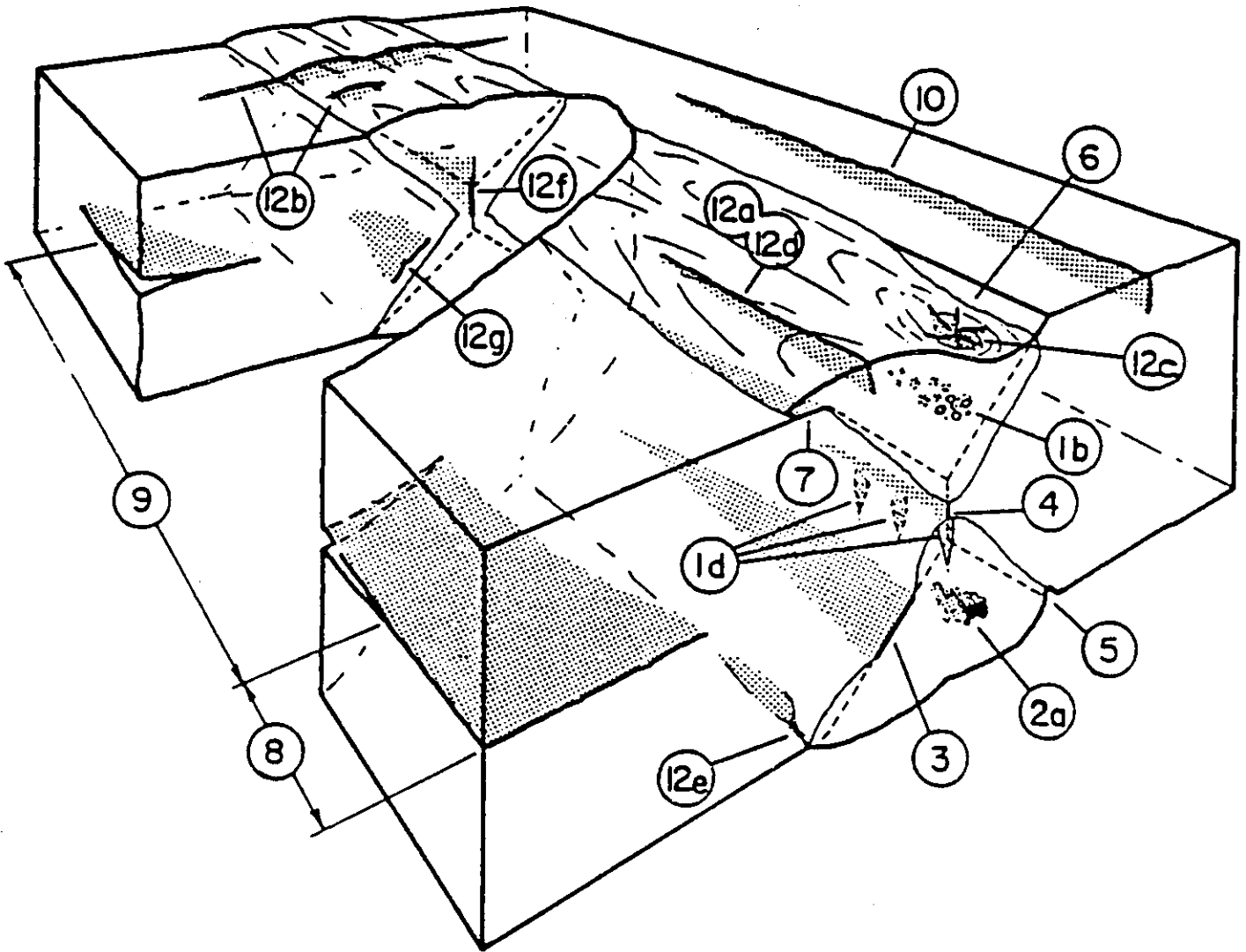

Figure 21: SCHEMATIC ILLUSTRATION OF WELD DISCONTINUITIES  
IN DOUBLE V-GROOVE WELD

## Porosity

Porosity is rounded voids caused by gas entrapped in solidifying weld metal. "Uniformly scattered porosity" may be distributed throughout single- or multi-pass welds. "Clustered porosity" is a localized grouping of pores often associated with weld bead start/stop locations. "Linear or aligned porosity" is pores aligned with a weld interface or the weld root. "Piping porosity" is a term for elongated gas pores.

At the levels generally permitted by industry codes and standards, porosity has little effect on the static strength or ductility of structural steel weldments. Under cyclic loading, the effects of porosity are generally overshadowed by the surface stress concentrations around the weld. If the surfaces of a butt weld are dressed flush, porosity exposed on the surface may contribute to fatigue crack initiation.

## Inclusions

"Slag inclusions" are non-metallic material entrapped in the weld, and may be present in welds made by flux-shielded processes. Sharp crevices at joint boundaries or between weld passes tend to trap slag. With proper technique, molten slag floats to the surface of the weld pool.

"Tungsten inclusions" are particles of tungsten electrode trapped in weld metal deposited with the gas tungsten arc welding process. These discontinuities may be caused if the tungsten electrode is inadvertently dipped into the weld pool, or if the current is too high causing melting of the electrode.

The influence of inclusions on weld integrity is similar to that of porosity. Moderate slag concentrations, up to about 4 volume percent of the weld zone, have little effect on the static properties of the lower strength

steel weld metals. Slag inclusions can influence the fatigue behavior of weldments, particularly inclusions at or near the surface, which create a greater stress concentration than similar, buried inclusions.

#### Incomplete Joint Fusion

Incomplete fusion is a failure to fuse and bond with either the base material or underlying weld passes. Incomplete fusion generally results from improper welding technique.

Incomplete fusion affects weld joint integrity in a manner similar to other rounded stress concentrations described previously, slag inclusions and porosity.

#### Inadequate Joint Penetration

When the weld zone fails to penetrate and fuse an area of the joint, the unfused area is described as inadequate penetration, as may happen for example in the root pass of groove welds.

Inadequate joint penetration may reduce the joint load-bearing area, and when present on the surface of single-groove welds, creates a severe stress concentration which would tend to initiate failure under cyclic loading.

#### Undercut

Undercut is a surface notch running parallel to the weld at the interface between weld metal and base metal. Undercut is often present to some degree. In severe cases, due to faulty technique, undercut adds to the stress concentration effect at the weld toes.



### Underfill

Underfill is simply the failure to completely fill the joint with weld metal, and is corrected by adding further weld metal.

### Overlap

Overlap is a cold shut or lap between the weld root or surface reinforcement and the adjacent base material. Overlap is created by incorrect welding procedures. Overlap creates a severe surface stress concentration.

### Cracks

Cracks are generally planar (or approximately so) discontinuities with a large ratio of length to opening displacement. Cracks may be formed at elevated or at low temperatures, may exist in the weld metal, the heat affected zone, or the base material, and may take a variety of orientations.

Cracking in its several forms is usually regarded as the weld discontinuity most detrimental to performance. A crack, by its very nature, is sharp at its extremities and thus acts as a severe stress concentrator. In addition, the presence of cracking signifies a loss of metallurgical control. Therefore cracks, regardless of size, are normally not permitted by most fabrication codes.

Cracks and crack-like discontinuities can be evaluated by fracture mechanics techniques when the material, the defect, and the stress conditions are well defined. This type of assessment is performed on high-value plant when repair would be difficult or impossible but continued service is desired. This approach is employed for instance to evaluate flaws detected during in-service inspection of nuclear reactor vessels.

## 4.2 Inspection

Inspection is a tool for achieving the desired quality or "fitness-for-purpose". Inspection of final product for acceptance or rejection does not alone make quality products. The only thing that puts quality into products is making them right in the first place. Inspection at appropriate times during manufacture according to a logical inspection plan enables quality to be monitored before defects are produced.

Welding inspectors must be familiar with all phases of the fabrication activities that apply to their product line. This includes understanding of requirements for welding procedure specifications, qualification testing and the application of various examination and testing methods, as well as a working knowledge of applicable codes, specifications and laws governing the quality of specific components. It is beneficial if inspectors are certified to a recognized standard, for example the Welding Inspector Qualification and Certification Program of the American Welding Society, or the Canadian Standards Association Standard W178 "Qualification Code for Welding Inspection Organizations".

Several Non-Destructive Examination (NDE) techniques are used to evaluate weldments, generally in order to (i) improve reliability by eliminating defects, (ii) to determine acceptability in accordance with a code or specification, (iii) to provide information for repair decisions, or (iv) to reduce costs by preventing further processing of defective material.

Non-destructive examination methods generally have the following elements:

- A probing medium (light, ultrasound, etc.)
- A component that is compatible with the probing medium
- A device for detecting effects or difference upon the probing medium
- A method for interpreting and acting upon the results.

The commonly used NDE methods for weldment inspection are:

1. Visual inspection (with or without optional aids) (VT)
2. Liquid penetrant (PT)
3. Magnetic particle (MT)
4. Radiography (RT)
5. Eddy current (ET)
6. Ultrasonic (UT)
7. Acoustic emission (AET)

The characteristics of these NDE techniques are described very briefly in the table below. More detailed discussion of NDE methods, procedures, and the type of discontinuity that each method will reveal is given in AWS B1.0 "Guide for Non-destructive Inspection of Welds" and "Welding Inspection" (2nd Ed, 1980), published by the American Welding Society. The AWS Handbook (Vol. 5) also gives a condensed review of NDE methods.

#### Nondestructive testing methods

Equipment needs	Applications	Advantages	Limitations
<b>Visual</b>			
Magnifiers, color enhancement, projectors, other measurement equipment, i.e., rulers, micrometers, optical comparators, light source.	Welds which have discontinuities on the surface.	Economical, expedient, requires relatively little training and relatively little equipment for many applications.	Limited to external or surface conditions only. Limited to the visual acuity of the observer/inspector.
<b>Radiography (Gamma)</b>			
Gamma ray sources, gamma ray camera projectors, film holders, films, lead screens, film processing equipment, film viewers, exposure facilities, radiation monitoring equipment.	Most weld discontinuities including cracks, porosity, lack of fusion, incomplete penetration, slag, as well as corrosion and fit-up defects, wall thickness, dimensional evaluations.	Permanent record—enables review by parties at a later date. Gamma sources may be positioned inside of accessible objects, i.e., pipes, etc., for unusual technique radiographs. Energy efficient source requires no electrical energy for production of gamma rays.	Radiation is a safety hazard—requires special facilities or areas where radiation will be used and requires special monitoring of exposure levels and dosages to personnel. Sources (gamma) decay over their half-lives and must be periodically replaced. Gamma sources have a constant energy of output (wavelength) and cannot be adjusted. Gamma source and related licensing requirements are expensive. Radiography requires highly skilled operating and interpretive personnel.

Equipment needs	Applications	Advantages	Limitations
<b>Radiography (X-Rays)</b>			
X-ray sources (machines), electrical power source, same general equipment as used with gamma sources (above).	Same applications as above.	Adjustable energy levels, generally produces higher quality radiographs than gamma sources. Offers permanent record as with gamma radiography (above).	High initial cost of x-ray equipment. Not generally considered portable. radiation hazard as with gamma sources, skilled operational and interpretive personnel required.
<b>Ultrasonic</b>			
Pulse-echo instrument capable of exciting a piezoelectric mat'l and generating ultrasonic energy within a test piece, and a suitable cathode ray tube scope capable of displaying the magnitudes of received sound energy. Calibration standards, liquid couplant.	Most weld discontinuities including cracks, slag, lack of fusion, lack of bond, thickness. Poisson's ratio may be obtained by determining the modulus of elasticity.	Most sensitive to planar type discontinuities. Test results known immediately. Portable. Most ultrasonic flaw detectors do not require an electrical power outlet. High penetration capability.	Surface condition must be suitable for coupling to transducer. Couplant (liquid) required. Small, thin welds may be difficult to inspect. Reference standards are required. Requires a relatively skilled operator/inspector. No record of results in most cases.
<b>Magnetic Particle</b>			
Prods, yokes, coils suitable for inducing magnetism into the test piece. Power source (electrical). Magnetic powders, some applications require special facilities and ultraviolet lights.	Most weld discontinuities open to the surface—some large voids slightly subsurface. Most suitable for cracks.	Relatively economical and expedient. Inspection equipment is considered portable. Unlike dye penetrants, magnetic particle can detect some near surface discontinuities. Indications may be preserved on transparent tape.	Must be applied to ferromagnetic materials. Parts must be clean before and after inspection. Thick coatings may mask rejectable indications. Some applications require parts to be demagnetized after inspection. Magnetic particle inspection requires use of electrical energy for most applications.
<b>Liquid Penetrant</b>			
Fluorescent or dye penetrant, developers, cleaners (solvents, emulsifiers, etc.). Suitable cleaning gear. Ultraviolet light source if fluorescent dye is used.	Weld discontinuities open to surface, i.e., cracks, porosity, seams.	May be used on all non-porous materials. Portable, relatively inexpensive equipment. Expedient inspection results. Results are easily interpreted. Requires no electrical energy except for light source. Indications may be further examined visually.	Surface films such as coatings, scale, smeared metal mask or hide rejectable defects. Bleed out from porous surfaces can also mask indications. Parts must be cleaned before and after inspection.
<b>Eddy Current</b>			
An instrument capable of inducing electromagnetic fields within a test piece and sensing the resulting electrical currents (eddy) so induced with a suitable probe or detector. Calibration standards.	Weld discontinuities open to the surface (i.e., cracks, porosity, lack of fusion) as well as some subsurface inclusions. Alloy content, heat treatment variations, wall thickness.	Relatively expedient, low cost. Automation possible for symmetrical parts. No couplant required. Probe does not have to be in intimate contact with test piece.	Limited to conductive materials. Shallow depth of penetration. Some indications may be masked by part geometry due to sensitivity variations. Reference standard required.
<b>Acoustic Emission</b>			
Emission sensors, amplifying electronics, signal processing electronics including frequency gates, filters. A suitable output system for evaluating the acoustic signal (audio monitor, visual monitor, counters, tape recorders, X-Y recorder).	Internal cracking in welds during cooling, crack initiation and growth rates.	Real time and continuous surveillance inspection. May be inspected remotely. Portability of inspection apparatus.	Requires the use of transducers coupled on the test part surface. Part must be in "use" or stressed. More ductile materials yield low amplitude emissions. Noise must be filtered out of the inspection system.

## 5.0 DRAWING SYMBOLS FOR WELDING AND NDE

Standard symbols for welding and NDE are used on engineering drawings to convey, concisely and precisely, the design requirements. The use of such symbols is much preferable to vague annotations such as "weld here", "weld all round", etc.

The complete system of symbols is described in AWS A2.4 "Symbols for Welding and Nondestructive Testing", published by the American Welding Society. Designers and drafting personnel should refer to this publication to select or interpret symbols. Information presented here describes the fundamentals of the symbols and how to apply them.

A complete welding symbol as shown in Figure 22 consists of the following elements:

1. Reference line (always shown horizontal)
2. Arrow
3. Basic weld symbol
4. Supplementary symbols
5. Tail
6. Dimensions and other data
7. Specifications, process, or other references.

All elements need not be used unless required.

The position of the basic weld symbol above or below the reference line is used to indicate whether the joint is welded from the side of the arrow, or the other side. As illustrated in Fig. 23, symbols depicting an "arrow-side" weld are always placed below the reference line. Symbols depicting an "other-side" weld are always placed above the reference line. If a joint is welded on both sides, the weld symbol is repeated above and below the line.

Some weld symbols, however, have no practical arrow or other side significance - for example, symbols for resistance spot welding.

To the basic welding symbol are added supplementary symbols and information to add further details of the required technique, such as backing, weld contour, weld and weld preparation dimension and welding process. Some examples are shown in Fig. 24 following.

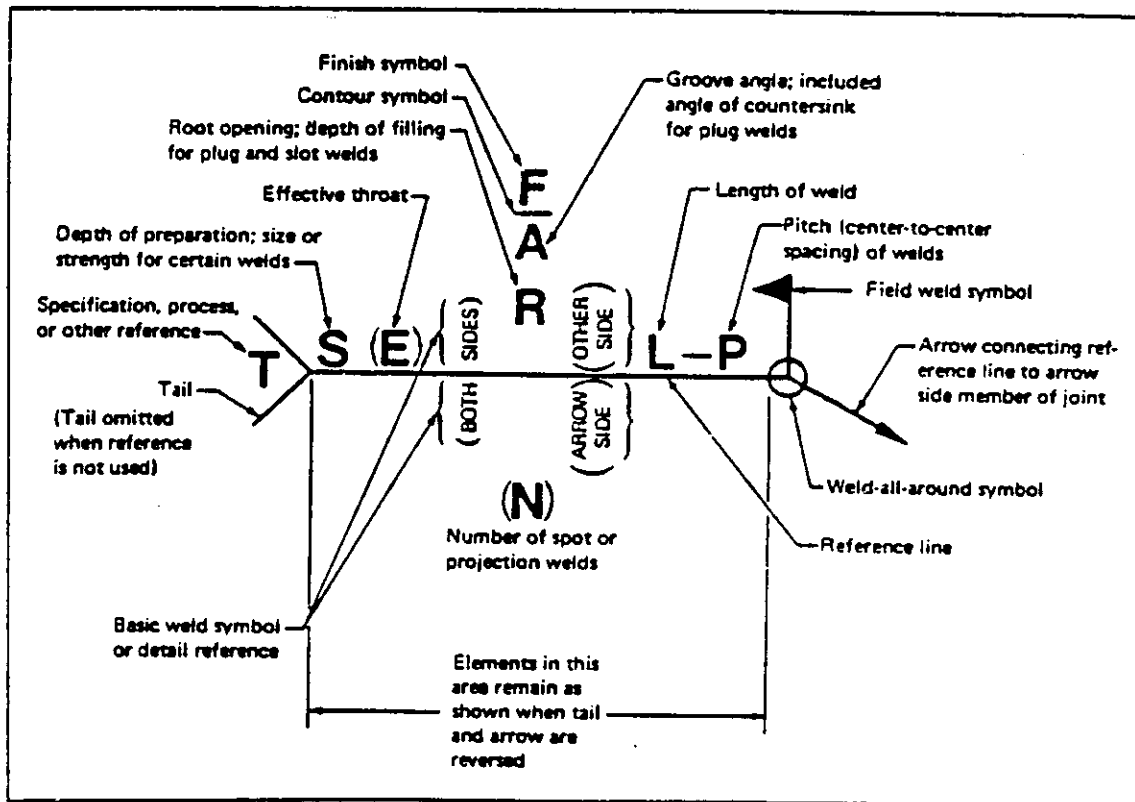

Figure 22(a): STANDARD LOCATION OF ELEMENTS OF A WELDING SYMBOL

Groove							
Square	Scarf*	V	Bevel	U	J	Flare-V	Flare-bevel

  

Fillet	Plug or slot	Spot or projection	Seam	Back or backing	Surfacing	Flange	
						Edge	Corner

Figure 22(b): BASIC WELD SYMBOLS

Weld all around	Field weld	Melt-thru	Backing or spacer material	Contour		
				Flush	Convex	Concave

Figure 22(c): SUPPLEMENTARY SYMBOLS

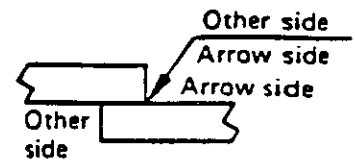
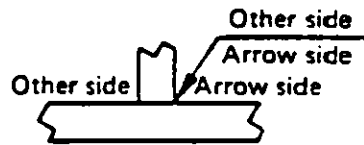
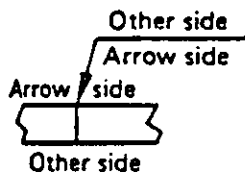

(A) Arrow and other side of a weld

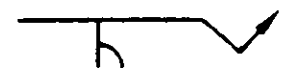
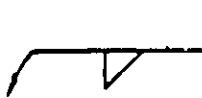

(B) Weld on arrow side

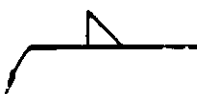

(C) Weld on other side

Figure 23: SIGNIFICANCE OF WELD SYMBOL LOCATION WITH RESPECT TO ARROW



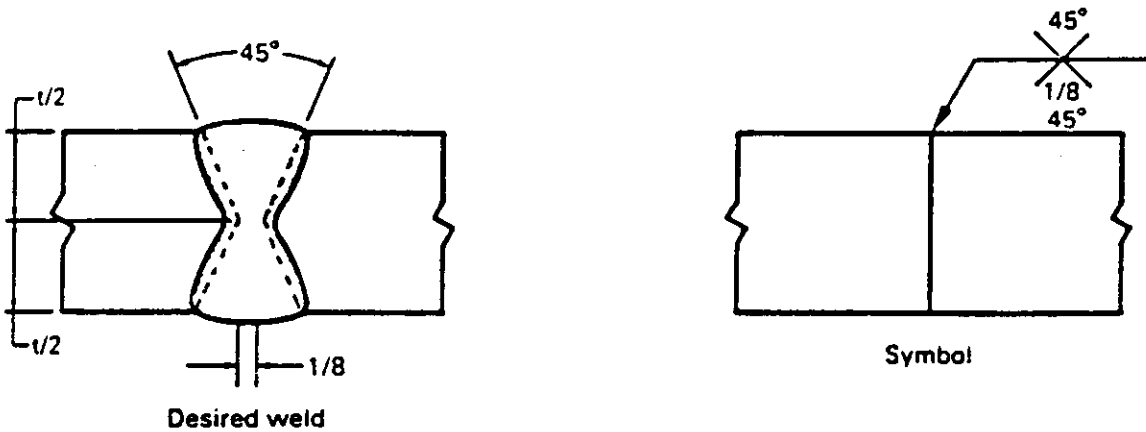

Depth of preparation (each side) –  $t/2$   
 Groove angle (each side) –  $45^\circ$   
 Root opening –  $1/8$  in.

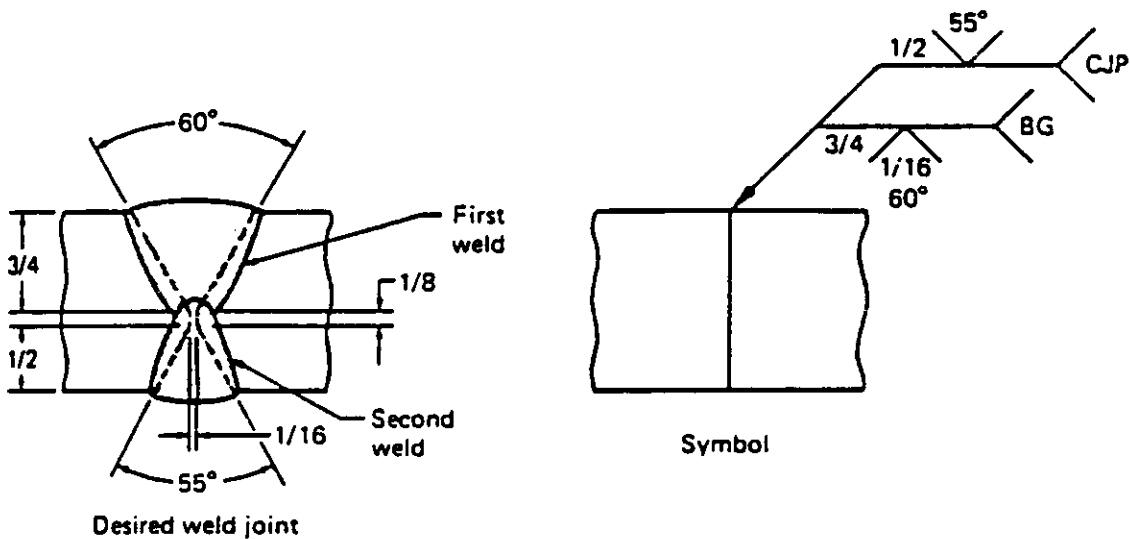

Depth of preparation (arrow side) –  $3/4$  in.  
 Depth of preparation (other side) –  $1/2$  in.  
 Root opening –  $1/16$  in.  
 Groove angle (arrow side) =  $60^\circ$   
 Groove angle (other side) =  $55^\circ$

Note: BG -- Back gouge to sound metal  
 CJP -- Complete joint penetration

Figure 24: EXAMPLES OF WELDING SYMBOL USE

NDE Symbols are similar in concept to weld symbols (Fig. 25) and are applied in similar fashion.

NON DESTRUCTIVE EXAMINATION SYMBOLS

<u>Type of Examination</u>	<u>Symbol</u>
Acoustic Emission Testing	AET
Eddy Current Testing	ET
Leak Testing	LT
Magnetic Particle	MT
Neutron Radiographic	NRT
Penetrant	PT
Proof Test	PRT
Radiographic	RT
Ultrasonic	UT
Visual	VT

As with welding symbols, the location of the NDE symbol below or above the reference line signifies examination of the arrow at the other side of the joint respectively. In addition, supplementary information may be added such as process specification references, length to be examined and the direction of RT examination.

NDE symbols may be combined with welding symbols or with each other if a part is to be examined by two or more methods.

Examples of various NDE symbols are shown in the Figure below.

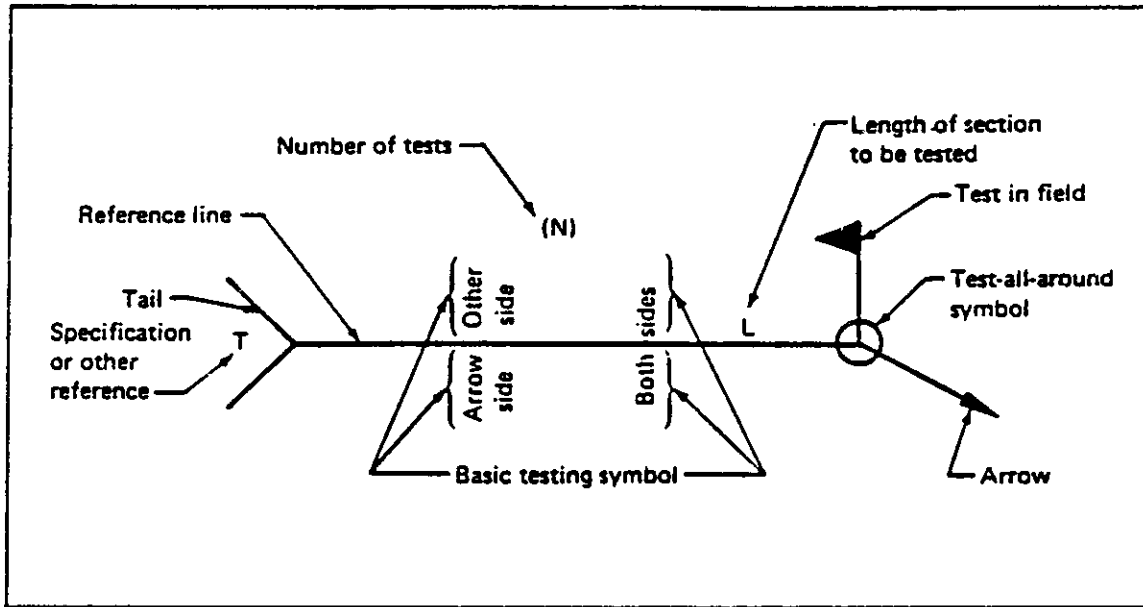

Figure 25: STANDARD LOCATION OF NDE SYMBOL ELEMENTS

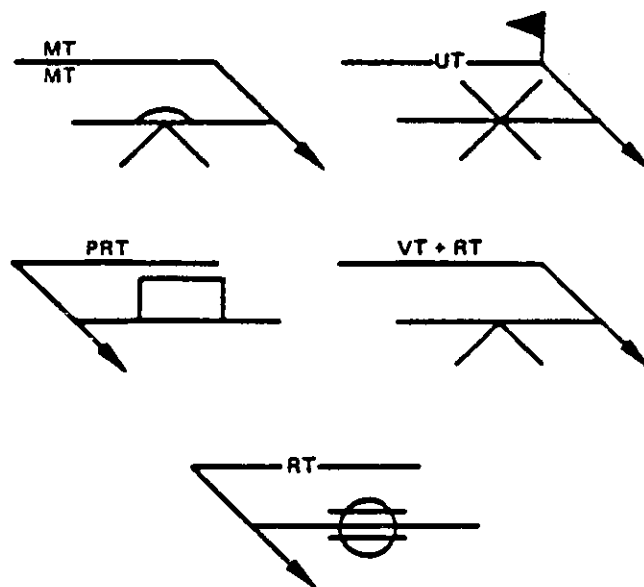

Figure 26: COMBINED NONDESTRUCTIVE EXAMINATION SYMBOLS

## 6.0 CODES AND STANDARDS

"Standards" are documents that describe the technical requirements for a material, process, product, system or service. They may also indicate the procedures, methods or tests used to determine that the requirements have been met.

Standards include codes, specifications, guides and recommended practices. Codes and specifications are generally couched in somewhat stronger language to indicate mandatory requirements. Guides and recommended practices are offered primarily as aids, because their use is usually optional.

Standards provide a common language which can be used confidently by purchaser, suppliers and other bodies to communicate requirements. Standards may be referenced by contractual agreement. In some applications, often when public safety may be affected, the use of certain codes or standards is mandatory by law -- eg. boiler & pressure vessel codes.

A large number of standards which govern or guide welding activities are issued by various national standards organizations, private and government bodies, and industry associations. The table below shows North American sources of welding-related standards.

The Canadian Standards Association is a voluntary membership organization engaged in standards development and also testing and certification. The CSA publishes a number of welding standards covering welding qualifications, applications, inspection, safety and material (see below). A subject index of CSA standards is available from the CSA.

U.S. standards are widely employed in Canada. The American Welding Society publishes numerous standards, covering the general subject areas of:

1. Definitions and symbols
2. Filler metals
3. Qualification and testing
4. Welding processes
5. Welding applications
6. Safety

Many of the AWS Standards have been adopted (sometimes with modifications) by other standards - making bodies. Thus the American Institute of Steel Construction (AISC) Specification for the Design, Fabrication and Erection of Structural Steel for Buildings refers to the AWS Structural Welding Code for welding and welder performance qualifications.

A catalogue of AWS publications may be obtained directly from the American Welding Society in Miami.

The American Society of Mechanical Engineers (ASME) publishes two codes of virtually worldwide importance for the power and process industries. The ASME Boiler and Pressure Vessel Code (B&PVC) consists of eleven sections. Sections I, III, IV and VIII cover the design, construction and inspection of power boilers, nuclear power plant components, heating boilers and unfired pressure vessels, respectively. Section II contains material specifications, including specifications for welding and brazing materials. Section V deals with methods and standards for non-destructive testing. Section IX "Welding and Brazing Qualifications" covers the qualification of welders, welding and brazing procedures that are to be employed on boilers or pressure vessels. This section of the ASME Code is often abstracted as the welding qualification standard for other types of product, something which should be done with caution.

The ASME B&PVC is referenced by the Canadian standards and the regulations of the provincial jurisdictions and the AECB for construction of nuclear power plants in Canada.

The ASME B31, "Code for Pressure Piping" presently consists of six sections:

B31.1 Power Piping

- .2 Fuel Gas Piping
- .3 Chemical Plant and Petroleum Refinery Piping
- .4 Liquid Petroleum Transportation Piping
- .5 Refrigeration Piping
- .8 Gas Transmission and Distribution Piping.

Section B31.1 "Power Piping" is employed for piping installations in CANDU plants.

### Sources of codes and standards of interest to the welding industry

American Association of State Highway and Transportation Officials (AASHTO) 444 N. Capital St., N.W. Washington, DC 20001 (202) 624-5800	Canadian Standards Association (CSA) 178 Rexdale Blvd. Rexdale, Ontario Canada M9W 1R3 (416) 744-4000
American Bureau of Shipping (ABS) 65 Broadway New York, NY 10006 (212) 440-0300	Compressed Gas Association (CGA) 1235 Jeff Davis Hwy. Arlington, VA 22202 (703) 979-0900
American Institute of Steel Construction (AISC) 400 N. Michigan Ave. Chicago, IL 60611 (312) 670-2400	International Organization for Standardization (ISO) (See American National Standards Institute)
American National Standards Institute (ANSI) 1430 Broadway New York, NY 10018 (212) 354-3300	National Board of Boiler and Pressure Vessel Inspectors (NBBPVI) 1055 Crupper Ave. Columbus, OH 43229 (614) 888-8320
American Petroleum Institute (API) 1220 L Street, N.W. Washington, DC 20005 (202) 457-7000	National Fire Protection Association (NFPA) Batterymarch Park Quincy, MA 02269 (617) 328-9290
American Railway Engineering Association (AREA) 2000 L Street, N.W. Washington, DC 20036 (202) 835-9336	Naval Publications and Forms Center <sup>1</sup> 5801 Taber Ave. Philadelphia, PA 19120 (215) 697-2000
American Society of Mechanical Engineers (ASME) 345 East 47th Street New York, NY 10017 (212) 705-7722	Pipe Fabrication Institute (PFI) 1326 Freeport Rd. Pittsburgh, PA 15238 (412) 782-1624
American Society for Testing and Materials (ASTM) 1916 Race Street Philadelphia, PA 19103 (215) 299-5400	Society of Automotive Engineers (SAE) 400 Commonwealth Dr. Warrendale, PA 15096 (412) 776-4841
American Water Works Association (AWWA) 6666 W. Quincy Ave. Denver, CO 80235 (303) 794-7711	Superintendent of Documents <sup>2</sup> U.S. Government Printing Office Washington, DC 20402 (202) 783-3238
American Welding Society (AWS) 550 N.W. LeJeune Road Miami, FL 33126 (305) 443-9353	Uniform Boiler and Pressure Vessel Laws Society (UBPVLS) 2838 Long Beach Rd. Oceanside, NY 11572 (516) 536-5485
Association of American Railroads (AAR) 1920 L Street, N.W. Washington, DC 20036 (202) 835-9100	

1. Military Specifications
2. Federal Specifications

## 7.0 REFERENCES & FURTHER READING

### Welded Design

ANSI/AWS D1.1 Structural Welding Code - Steel, latest edition, Miami FL.,  
American Welding Society.

ANSI/AWS D1.2 Structural Welding Code - Aluminum, latest edition, Miami FL.,  
American Welding Society.

CSA W59 "Welded Steel Construction" , latest edition, Toronto, Ontario,  
Canadian Standards Association.

Welding Handbook, 7th Edition, Vol. 5 (1984): "Engineering, Costs, Quality &  
Safety" Miami FL., American Welding Society.

Richards K.G. (1976) "Joint Preparations for Fusion Welding of Steel" Abington,  
UK, The Welding Institute.

ANSI/ASME B16.25 Butt Welding Ends, latest edition, New York, NY., American  
Society of Mechanical Engineers.

Richards K.G. (1969) "Fatigue Strength of Welded Structures" Abington, UK,  
The Welding Institute.

Richards, K.G. (1971) Brittle Fracture of Welded Structures, Abington, UK,  
The Welding Institute.

Pellini W.S. and P.P. Puzak (1963) "Fracture Analysis Diagram Procedures for The  
Fracture-Safe Engineering Design of Steel Structures" New York NY., Welding  
Research Council Bulletin No. 88.

Control of Distortion in Welded Fabrication (1968). Abington, UK, The Welding  
Institute.



## Welding Processes

Welding Handbook 5th Edition, Volume 1 (1984) "Fundamentals"; Vol 2 "Arc and Gas Welding Cutting Brazing and Soldering"; Vol 3 "Resistance and Solid State Welding and Other Joining Processes" Miami FL., American Welding Society.

Metals Handbook 9th Edition Volume 6 (1983) "Welding Brazing & Soldering" Metals Park. Ohio, American Society for Metals.

Houldcroft, P.T. (1977) "Welding Process Technology" London, UK, Cambridge University Press.

Schwarz M.M. (1979) "Metals Joining Manual" New York NY., McGraw Hill.

## Weldment Quality

Welding Inspection, latest edition, Miami FL., American Welding Society.

AWS B1.0 Guide for the Nondestructive Inspection of Welds, latest edition, Miami FL., American Welding Society.

Guide to AWS Welding Inspector Qualification & Certification, latest edition, Miami FL., American Welding Society.

CSA W178 Qualification Code for Welding Inspection Organisations, latest edition, Toronto Ontario, Canadian Standards Association.

CSA W178.2 Certification of Welding Inspectors, latest edition, Toronto, Ontario, Canadian Standards Association.

Nichols R.W.E. (Ed.) (1979) "Developments in Pressure Vessel Technology - 2: Inspection and Testing" London UK, Applied Science Publishers.

Lundin, C.D. (1976) "The Significance of Weld Discontinuities - A Review of The Current Literature" New York NY., Welding Research Council, Bulletin No. 222.

BSI PD6493 (1980) "Guidance on Some Methods for the Derivation of Acceptance Levels for Defects in Fusion Welded Joints" London, UK, British Standards Institution.

#### Symbols for Welding & NDE

AWS A2.4 Symbols for Welding and Non-Destructive Testing, latest edition, Miami FL., American Welding Society.

#### Codes & Standards

Moore, C.V. (1965) "An Introduction to The ASME Unfired Pressure Vessel Code" New York, NY., American Society for Mechanical Engineers Publication 65-WA/MET-15.

Welding Handbook 7th Edition Volume 5 (1984) "Engineering, Costs, Quality and Safety" Miami FL., American Welding Society.

#### Terms & Definitions

AWS A3.0 Welding Terms & Definitions, latest edition, Miami FL., American Welding Society.

General Sources of Educational and Training Publications:

American Welding Society (AWS)

55 N.W. LeJeune Rd.,  
PO Box 351040,  
Miami, FL., 33135.

Welding Institute of Canada (WIC)

391 Burnamthorpe Rd.,  
Oakville,  
Ontario L6J 6C9. (416) 845-9881

Canadian Welding Bureau (CWB)

254 Merton St.,  
Toronto,  
Ontario M4S 1A9. (416) 487-5415

The Welding Institute (TWI)

Abington Hall,  
Abington,  
Cambridge, UK CB1 6AL.

The Edison Welding Institute (EWI)

1100 Kinnear Rd.,  
Columbus OH. 43212. (614) 486-9400  
(Associate of TWI)