

CANDIDATE SITE CHARACTERIZATION

- *SURFACE GEOLOGIC MAPPING*
- *SURFACE GEOPHYSICAL SURVEYS*
- *HYDROGEOLOGICAL MAPPING*
- *DRILLING, LOGGING, SAMPLING, TESTING AND MONITORING*
- *UNDERGROUND HYDROGEOLOGIC INVESTIGATIONS*

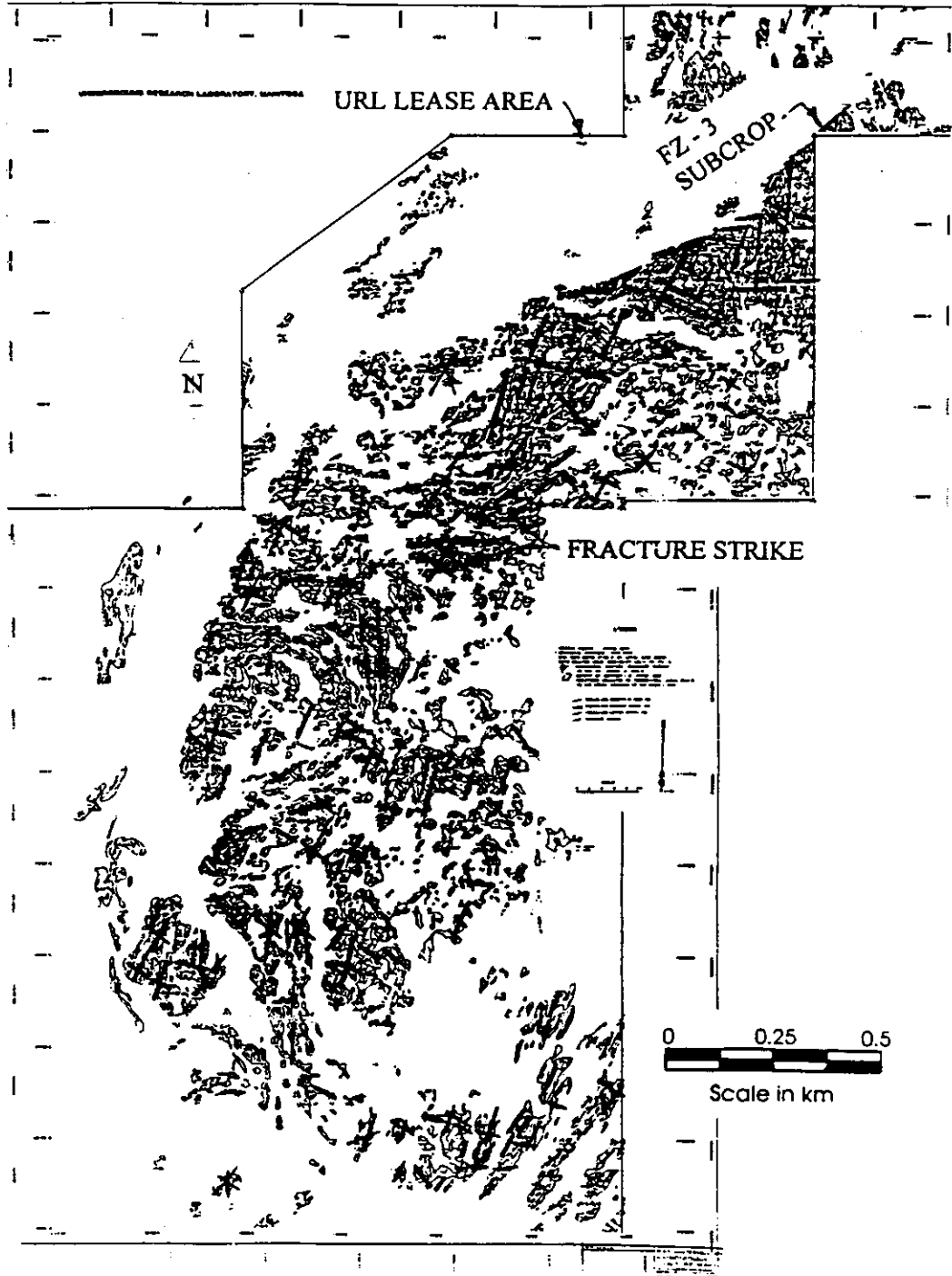

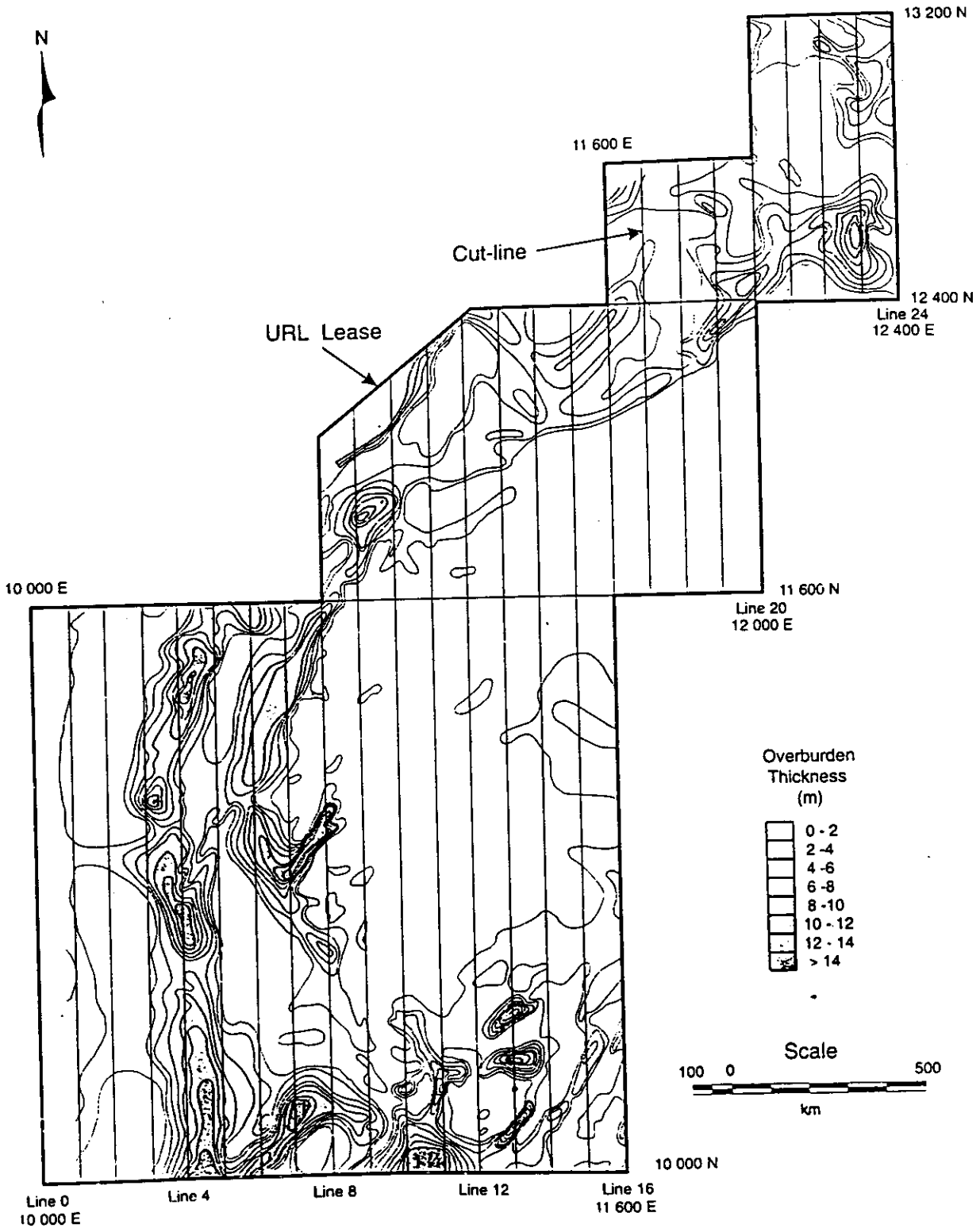



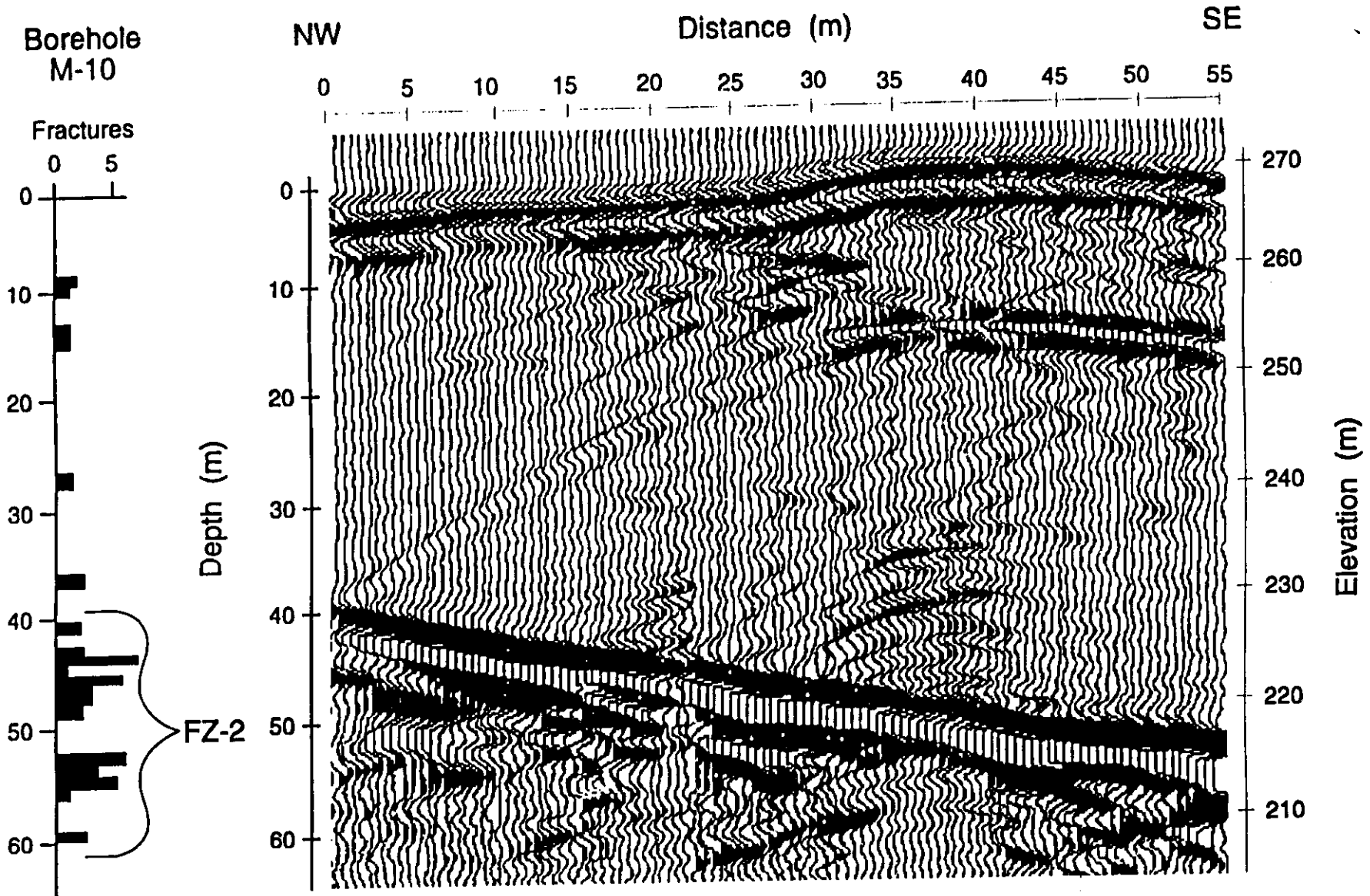

Velocity = 0.120 m/ns
 Time Scale 0 to 1100 ns
 (two way travel time)

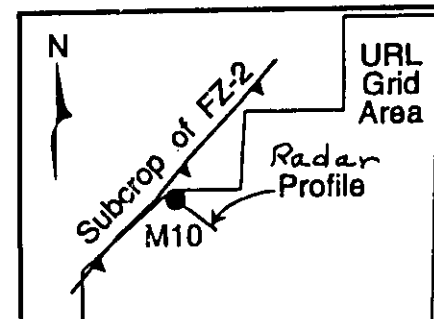

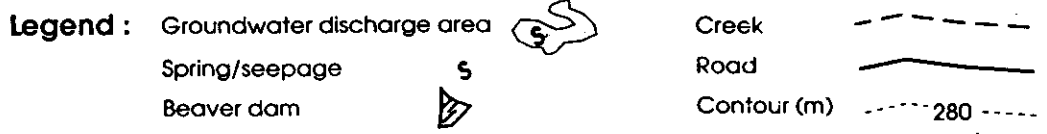
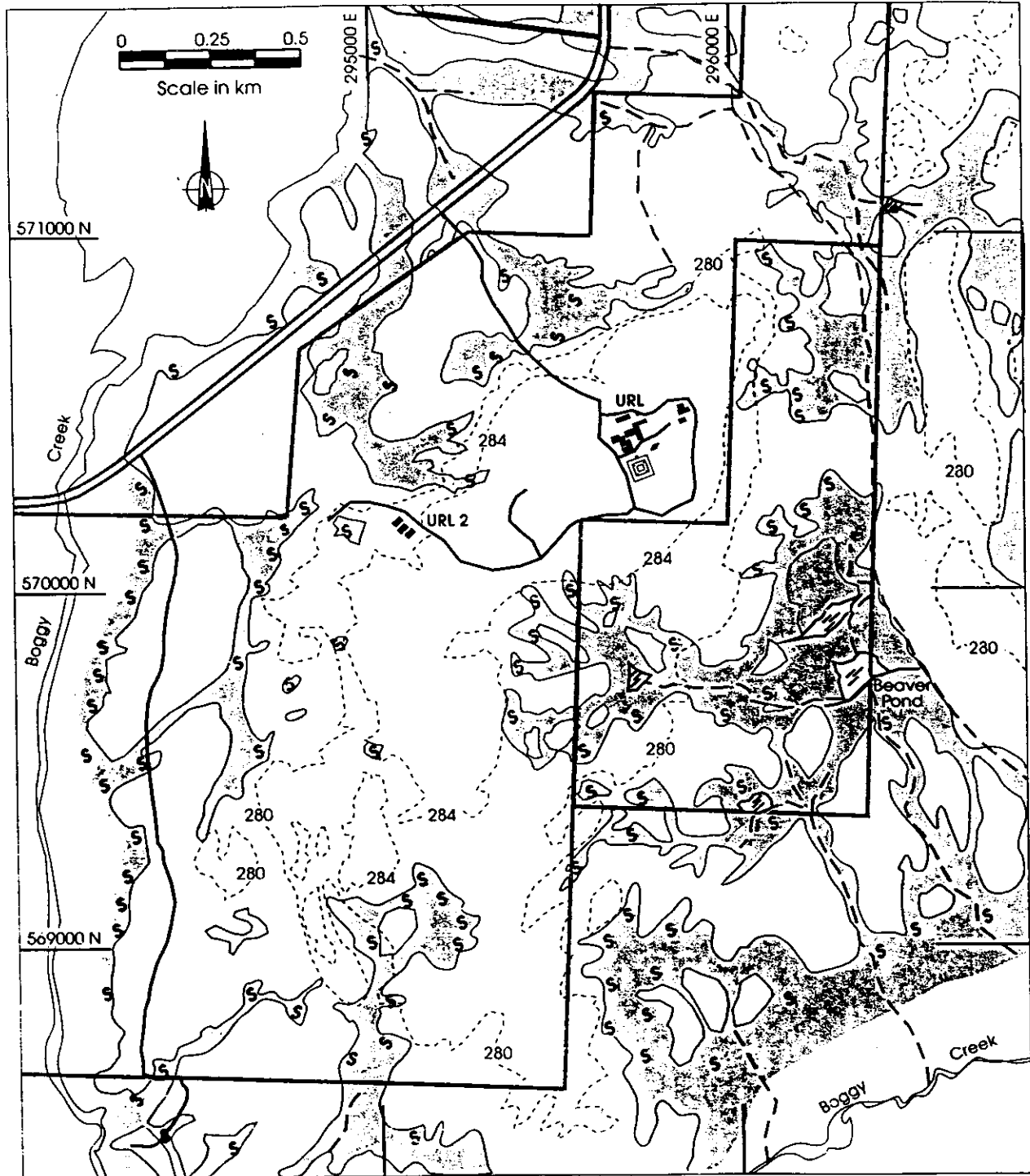

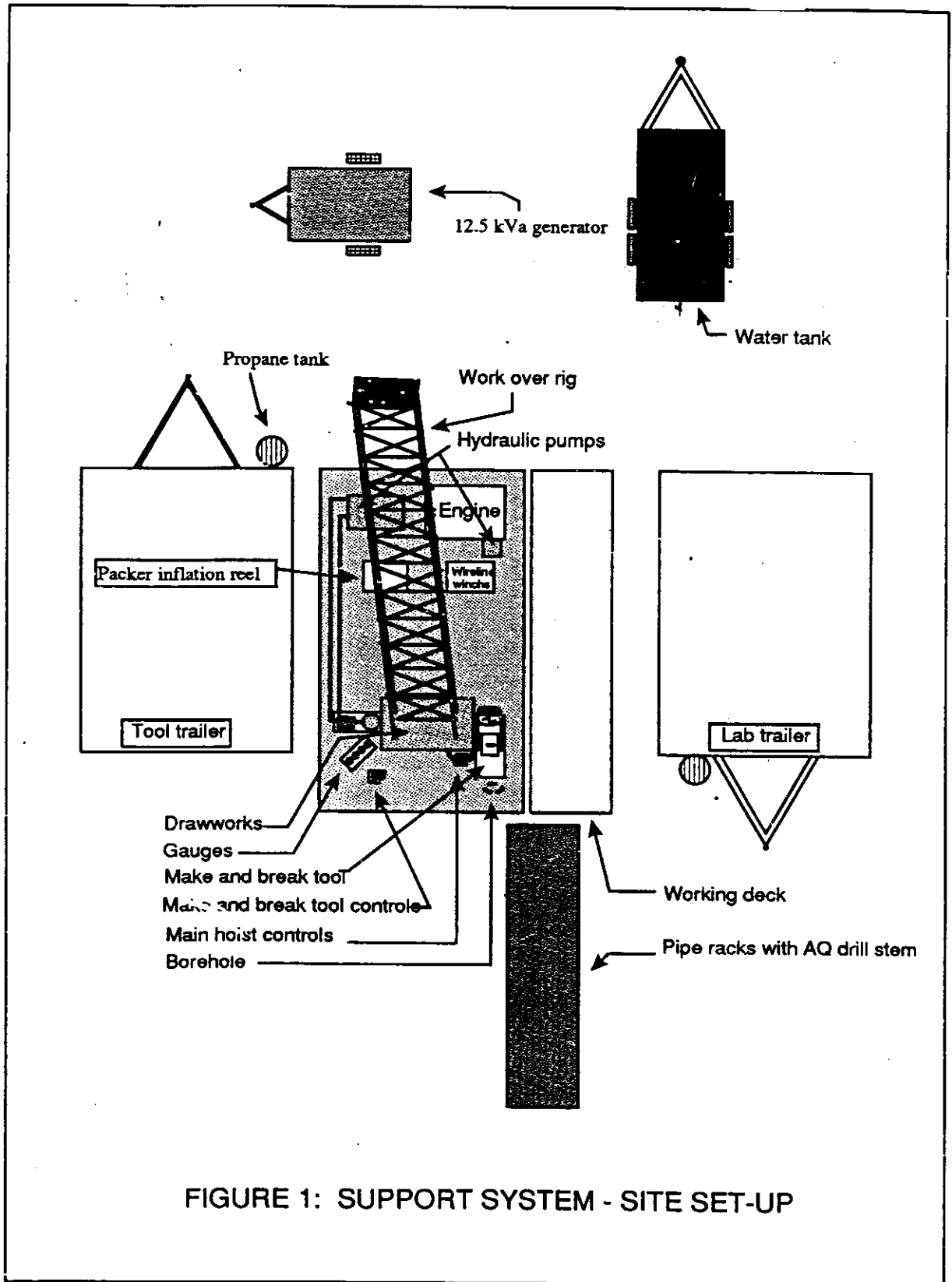
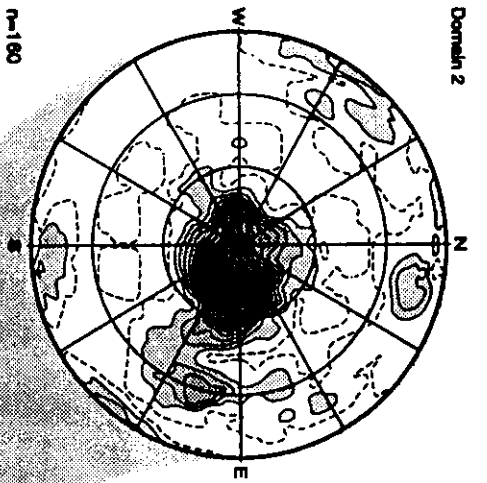
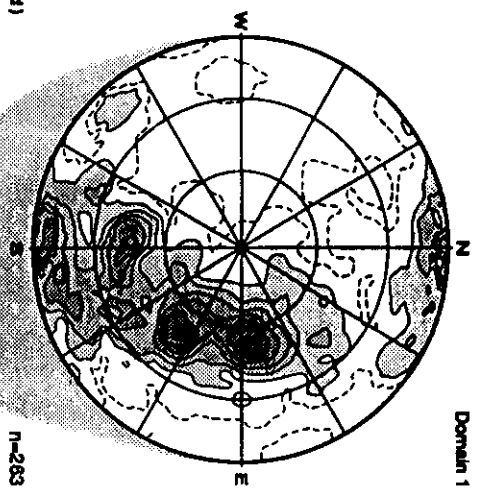

FIGURE 1: SUPPORT SYSTEM - SITE SET-UP



Domain 2
Equal Area Projection
1% Scanning Circle



Domain 1

n=263

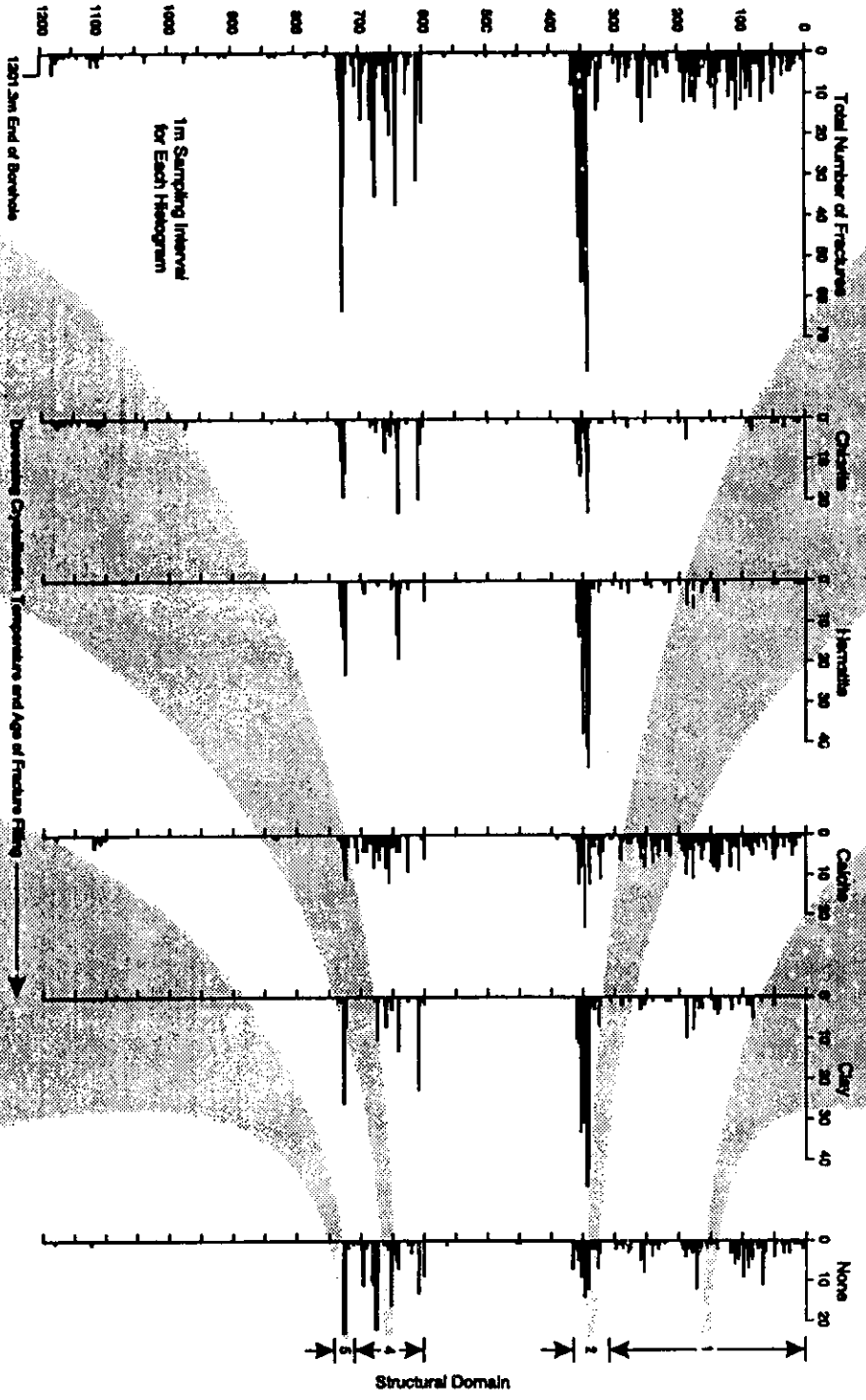

Structural Domain

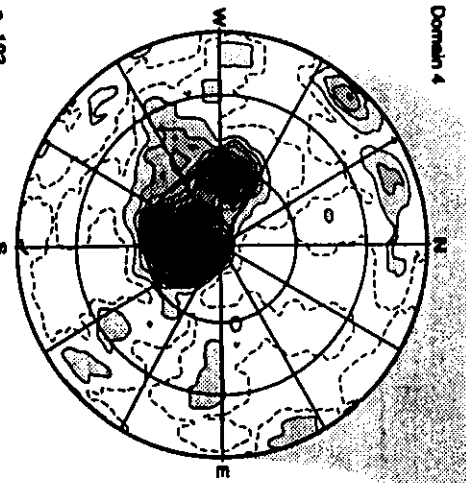

Domain 4

n=183

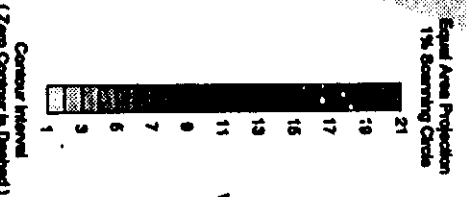

Equal Area Projection
1% Scanning Circle

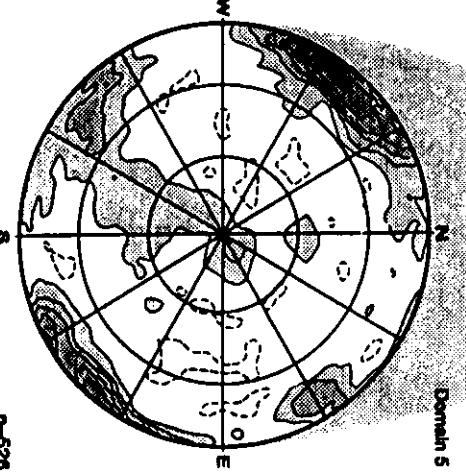

Domain 5

n=526

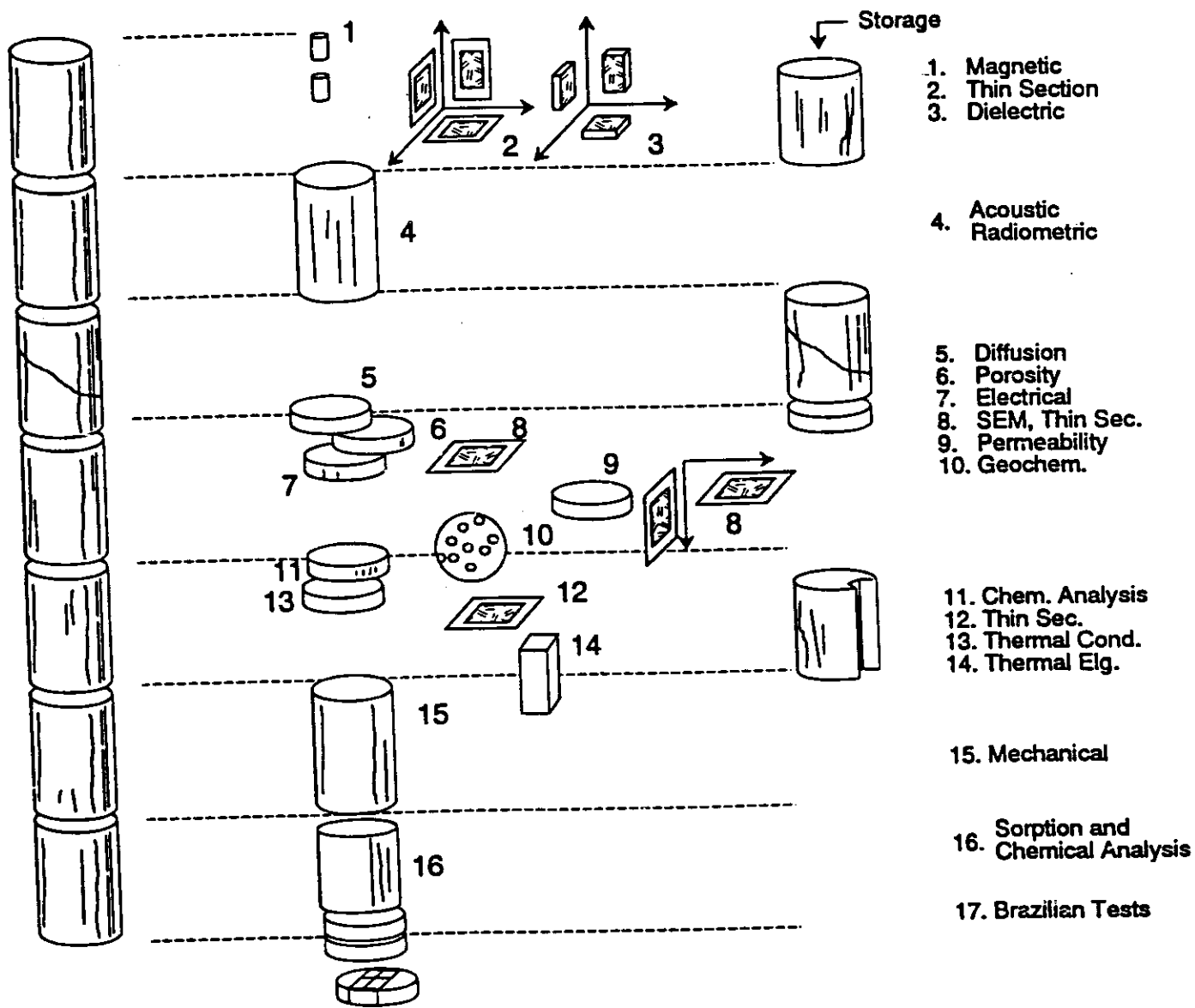

IRE 6-11: Schematic of Core Sampling Distribution

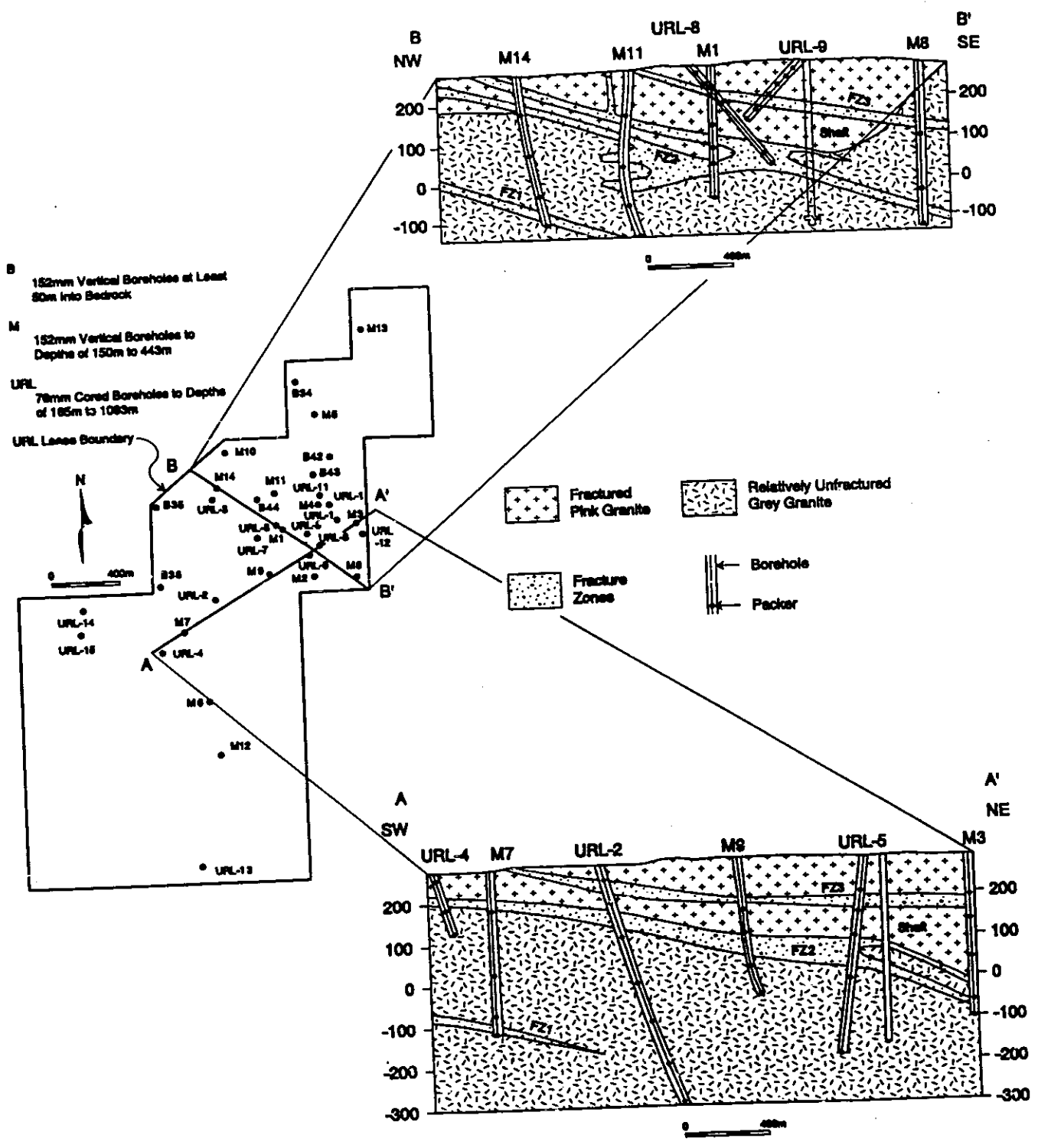

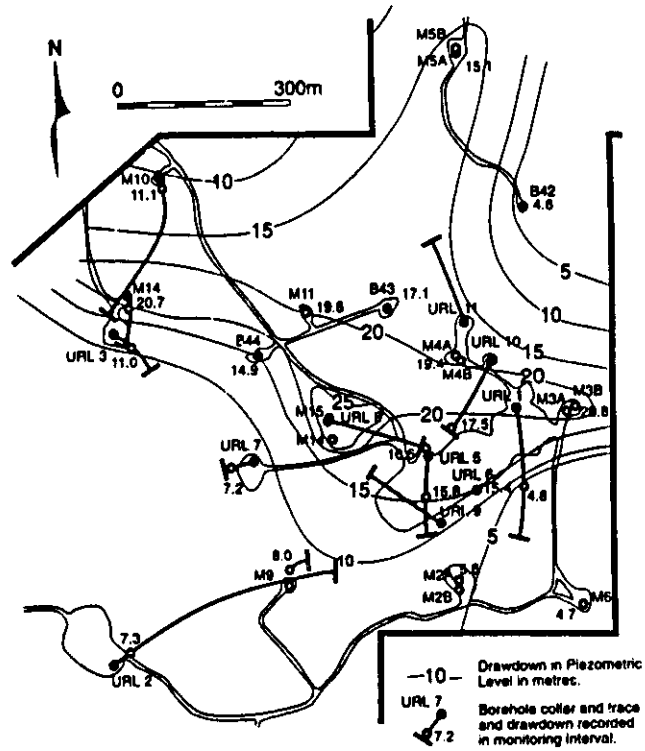

a) Drawdown in Observation Wells in FZ-2 in Response to Pumping at M1A (after 7400 min. of pumping), July 1983 test

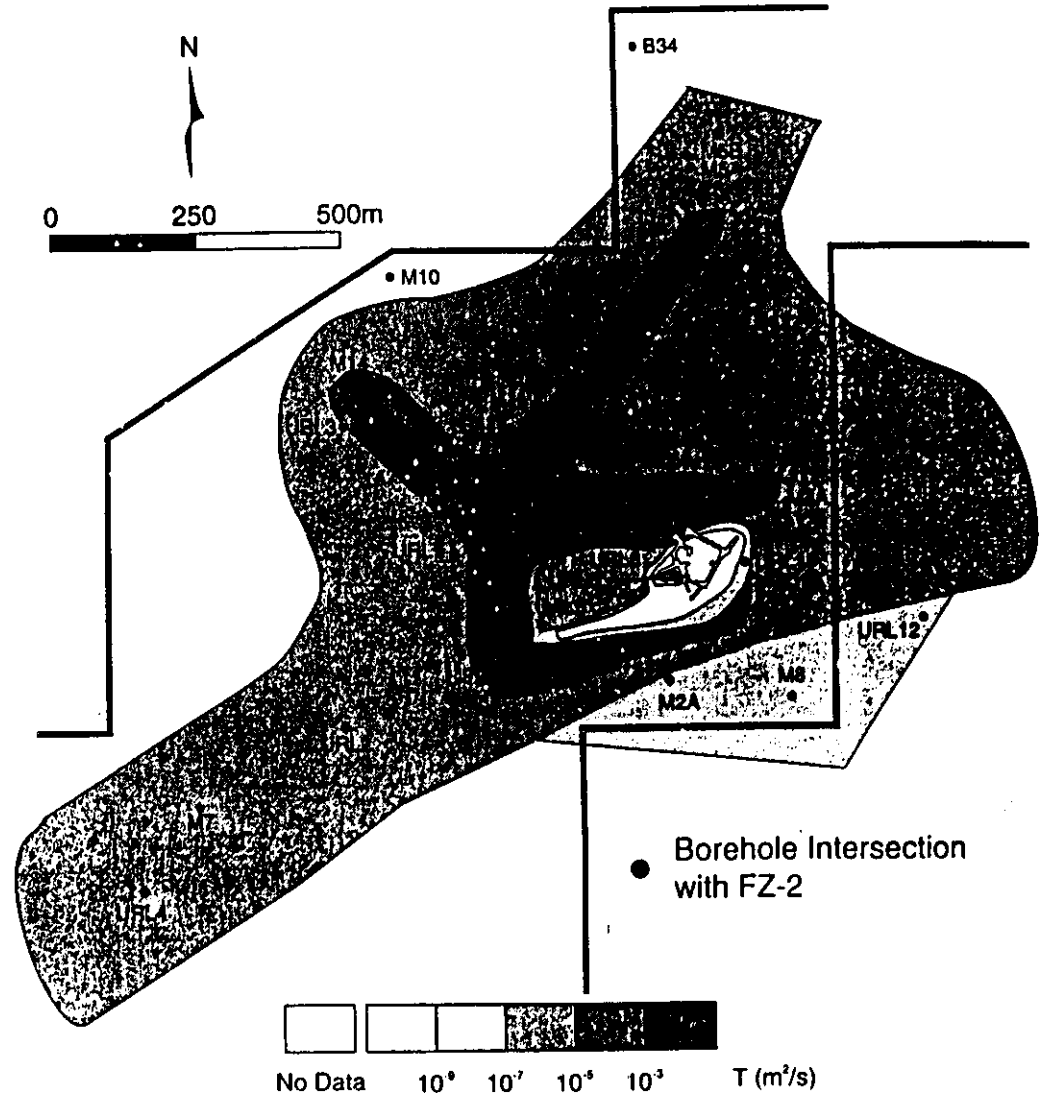

b) Transmissivity (T) Pattern within FZ-2

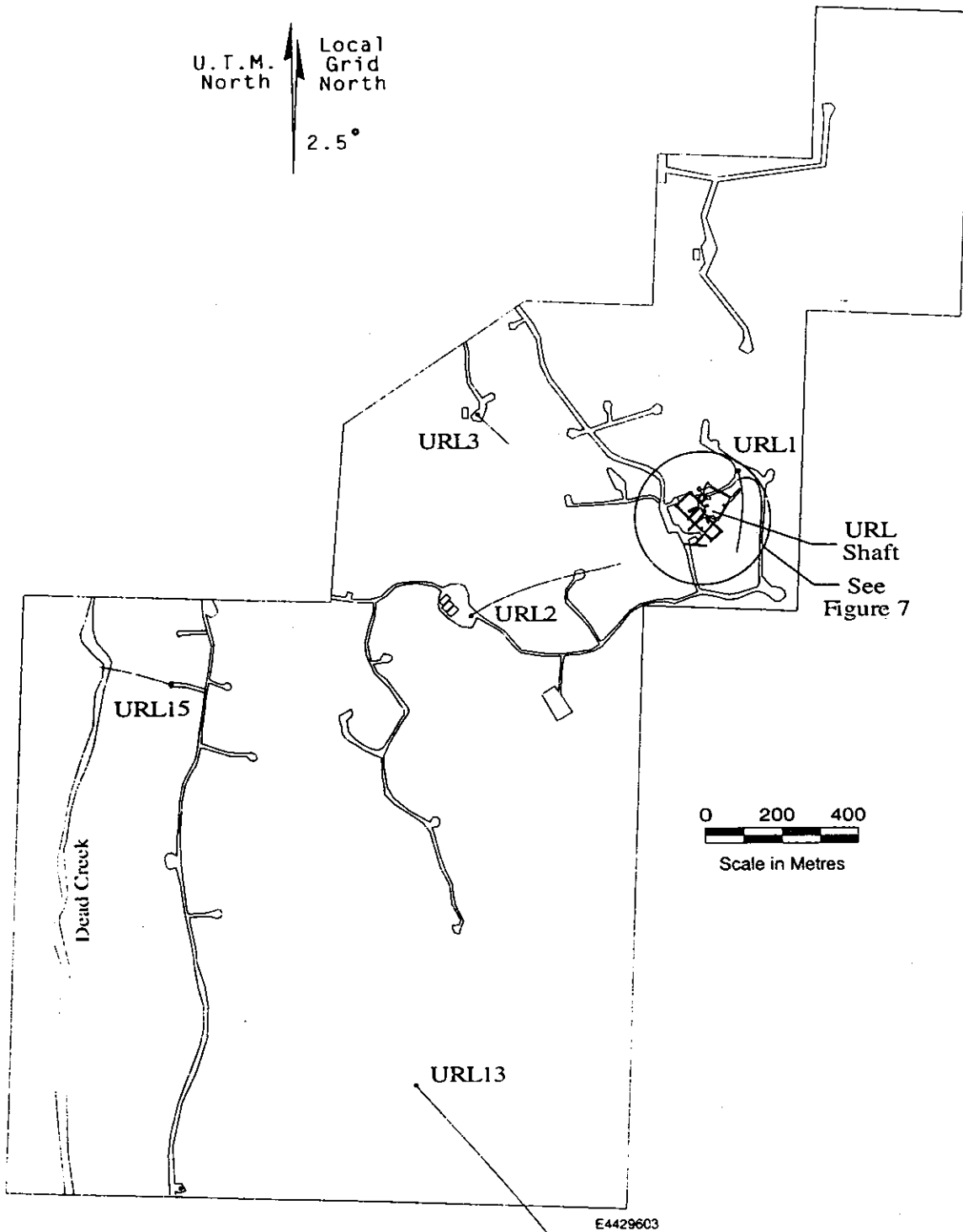

Figure 6 Location of boreholes collared at ground surface at the URL in which straddle packer injection tests were done in sparsely fractured rock.

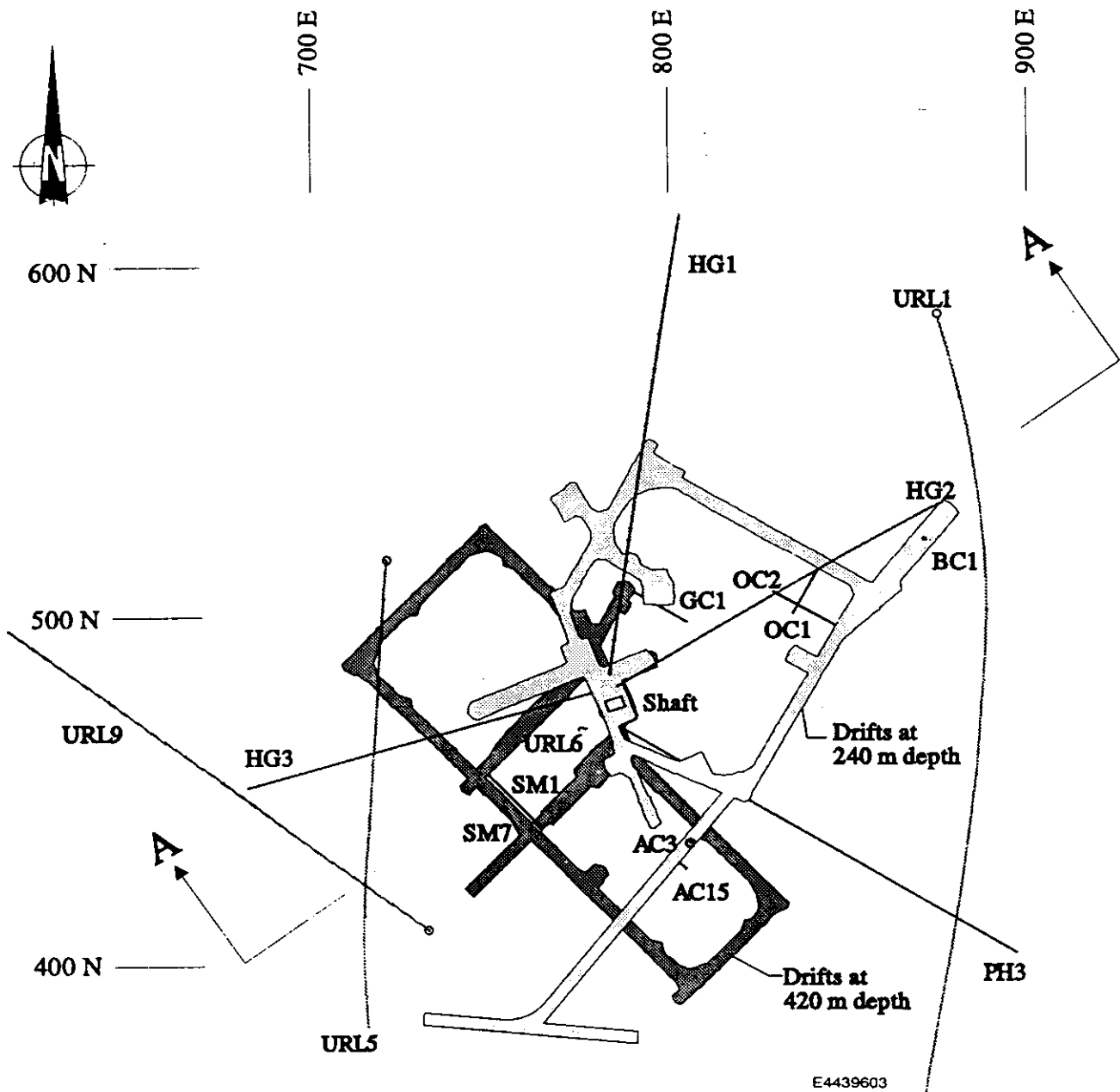

Figure 7 Plan view of drifts at the 240 m and 420 m depths, horizontal traces of surface boreholes URL1,5 and 9, underground boreholes used for water sampling and piezometric level monitoring, and the location of Section A-A (Figure 8) at the URL.

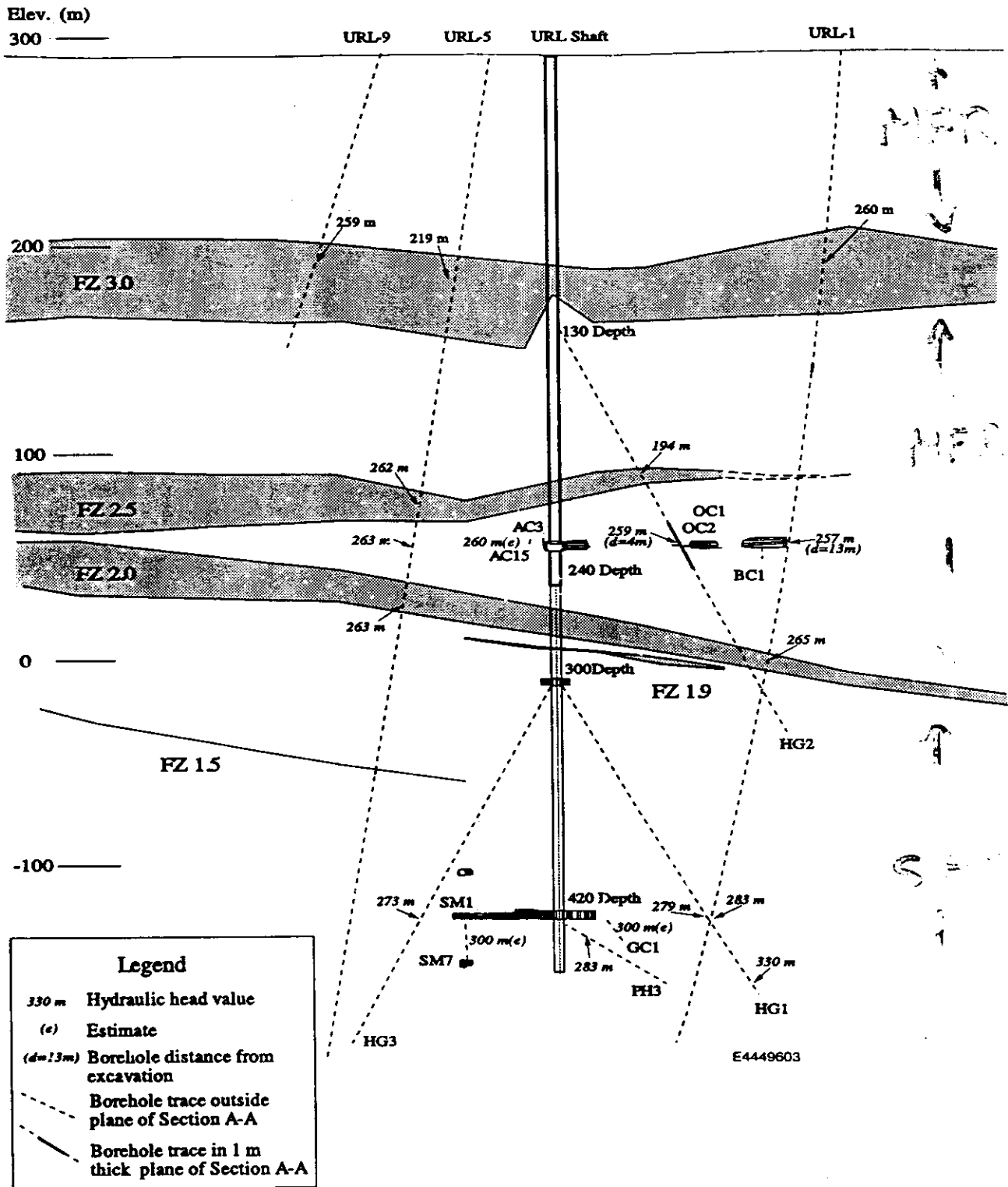
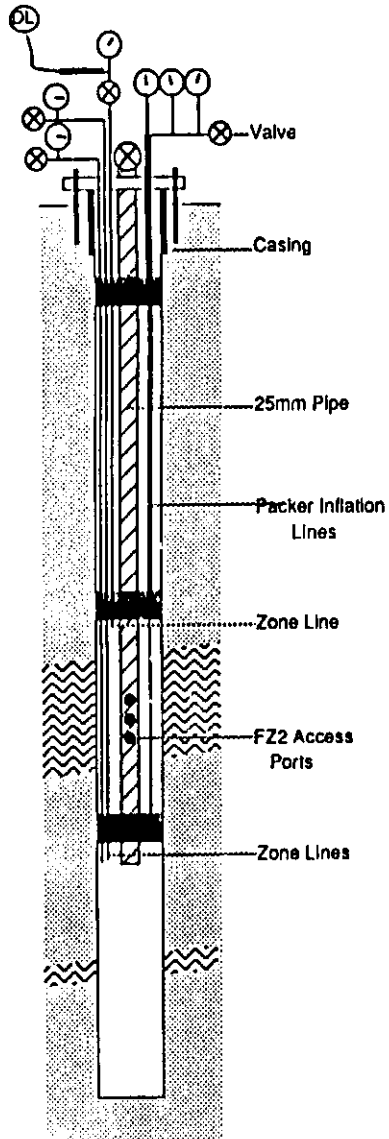

Figure 8 Section A-A (from Figure 7) showing vertical traces of boreholes and hydraulic head values at selected depths, and locations of boreholes where pore water seepages was collected.

Figure 1: Hydrogeological Packer Systems for Underground Hydrogeological Characterization

Type 2: FZ2 Borehole Packer System



Type 1: Horizontal Borehole Packer System

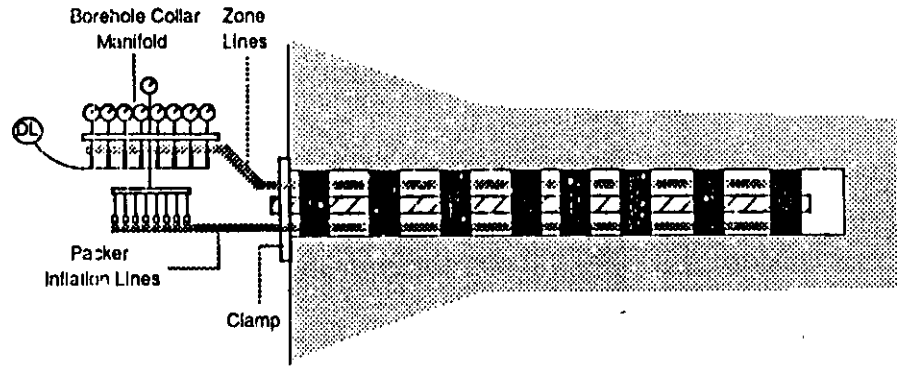

EDA Packer System

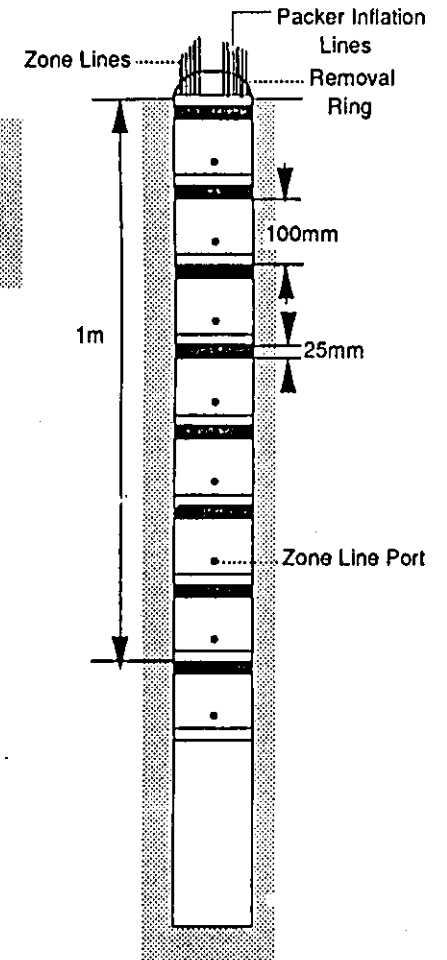

Type 3: Pac-Ex Packer Systems

a) Straddle Packer Pac-Ex

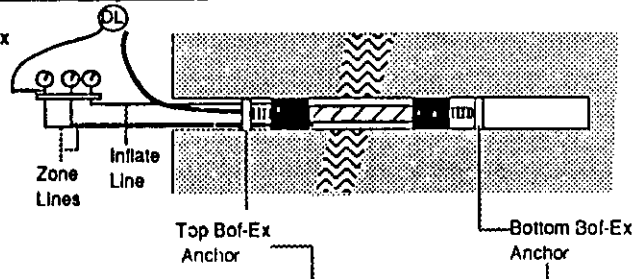

b) Single Packer Pac-Ex

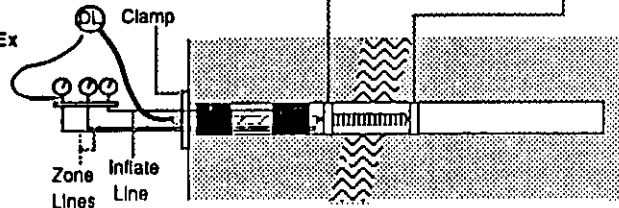

KEY

	Bof-Ex Extensometer		Vibrating Wire Pressure Transducer		Mandrel
	Pressure Gauge		Packer		Fracture Zone
	To Data Logger				

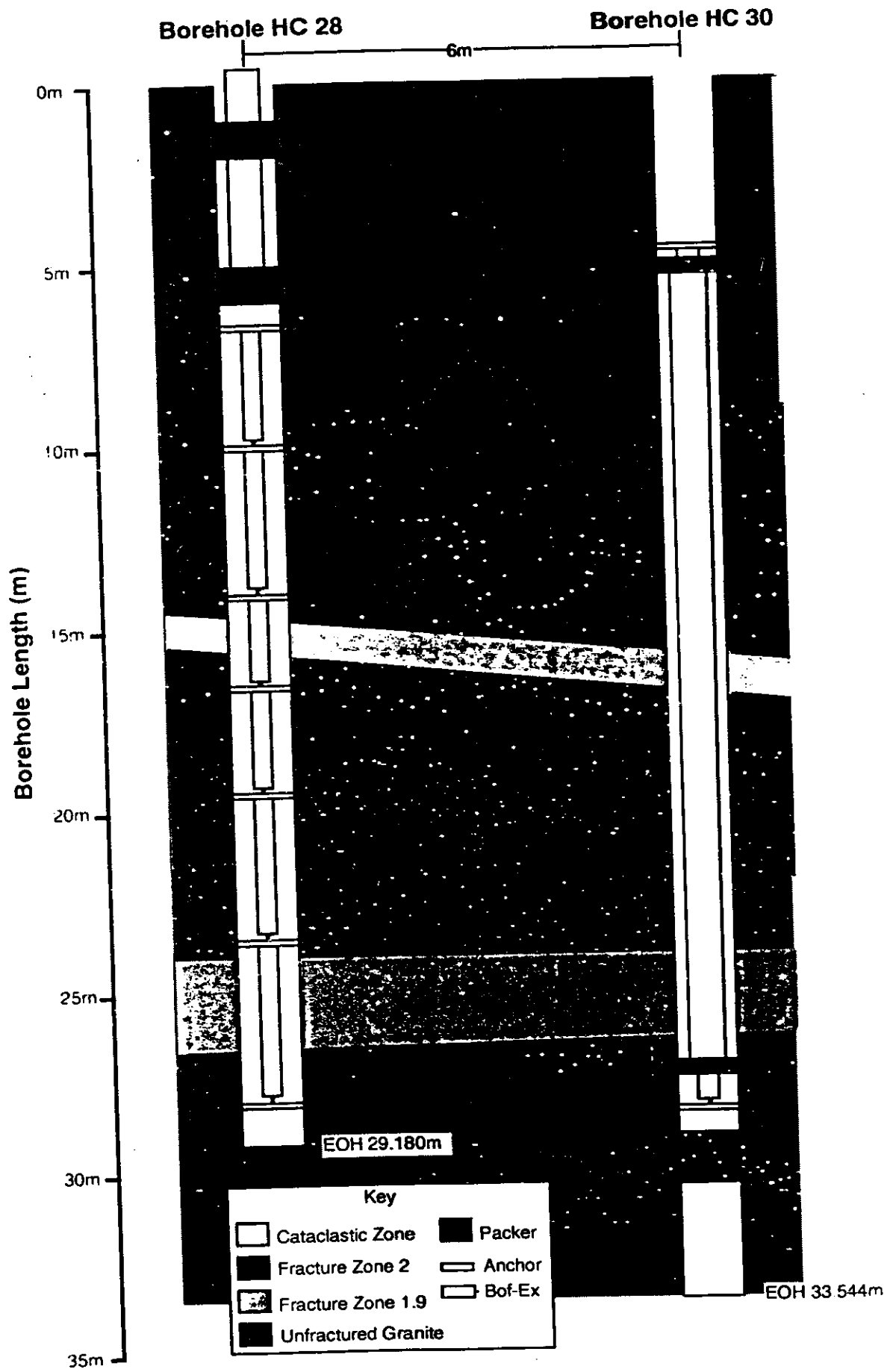



Normal Stress on FZ#2

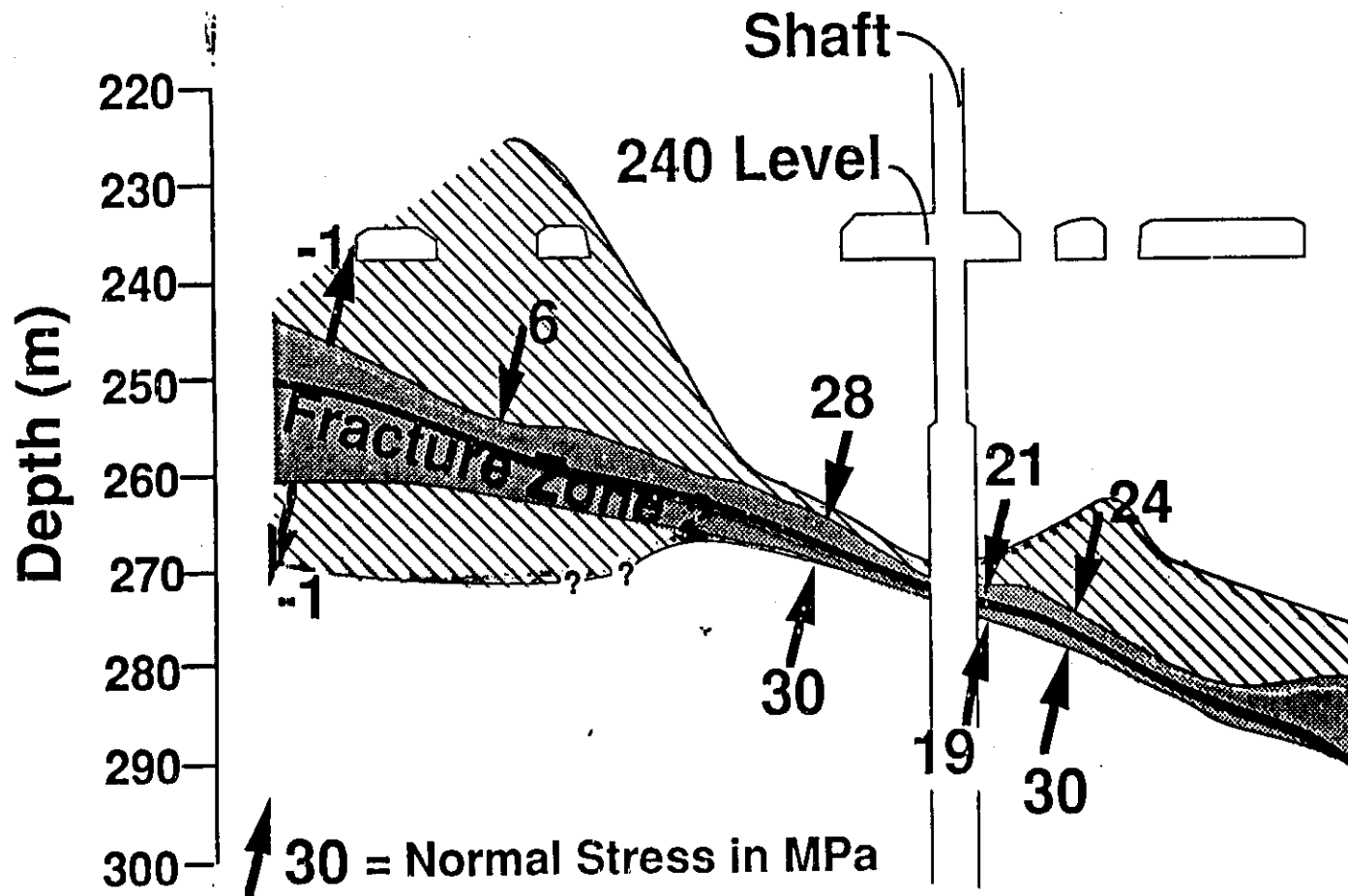



Pac-ex & Response

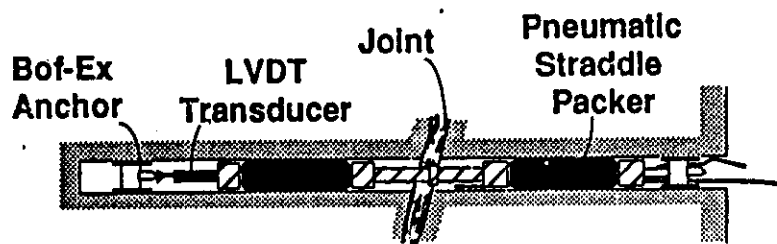

Double Packer Pac-ex

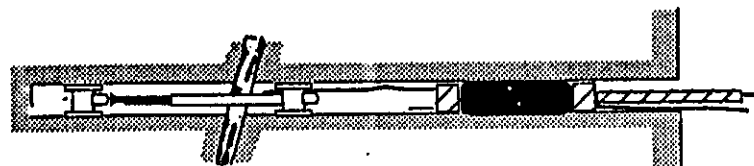

Single Packer Pac-ex

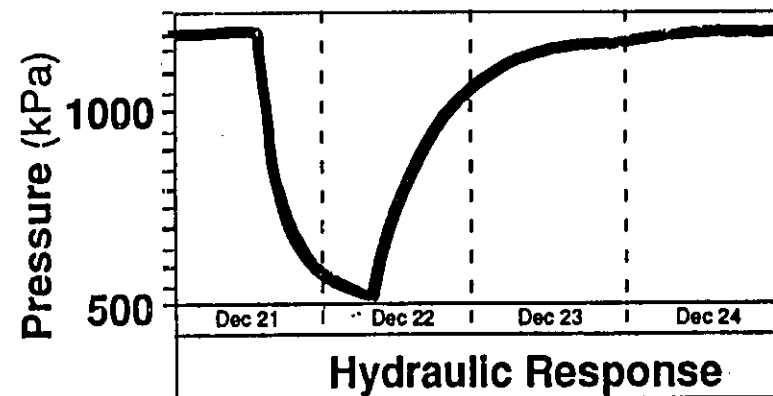
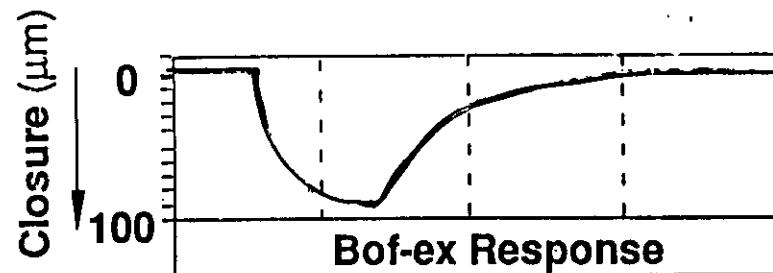

Fracturezone 2 Compressibility Testing Borehole HC30 - Displacement vs Δ Hydraulic Head

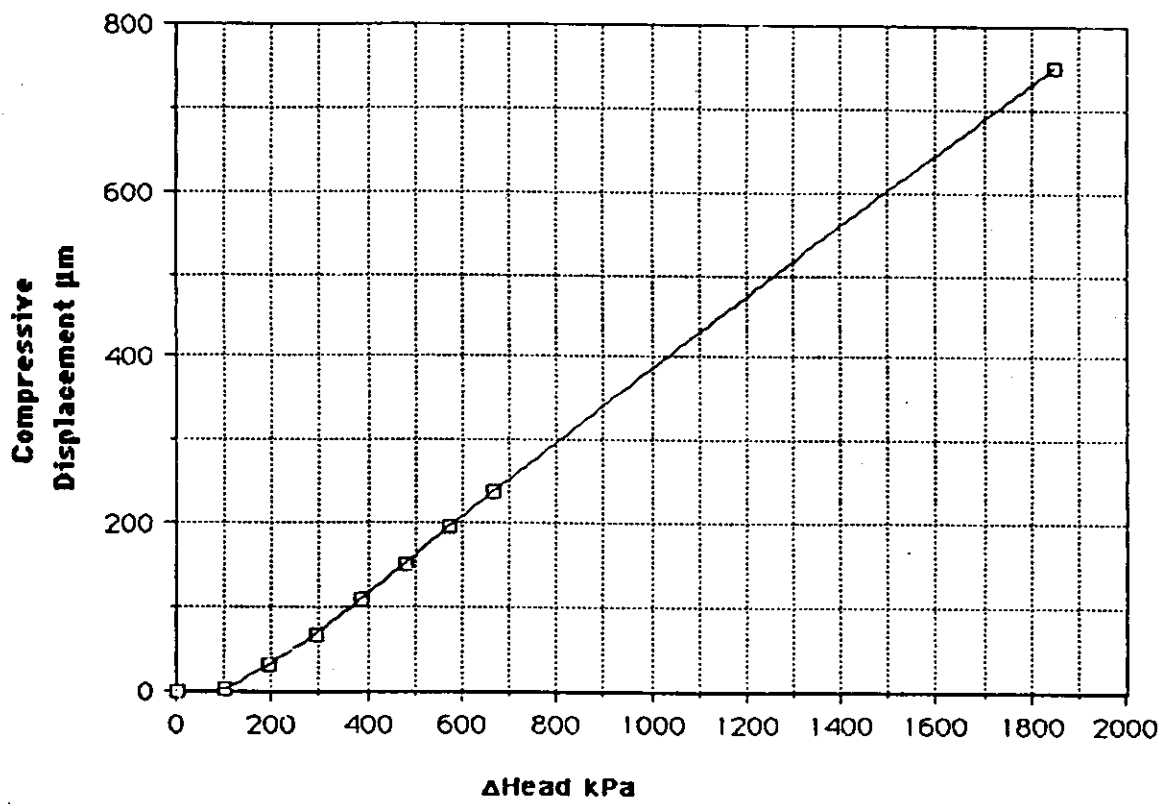

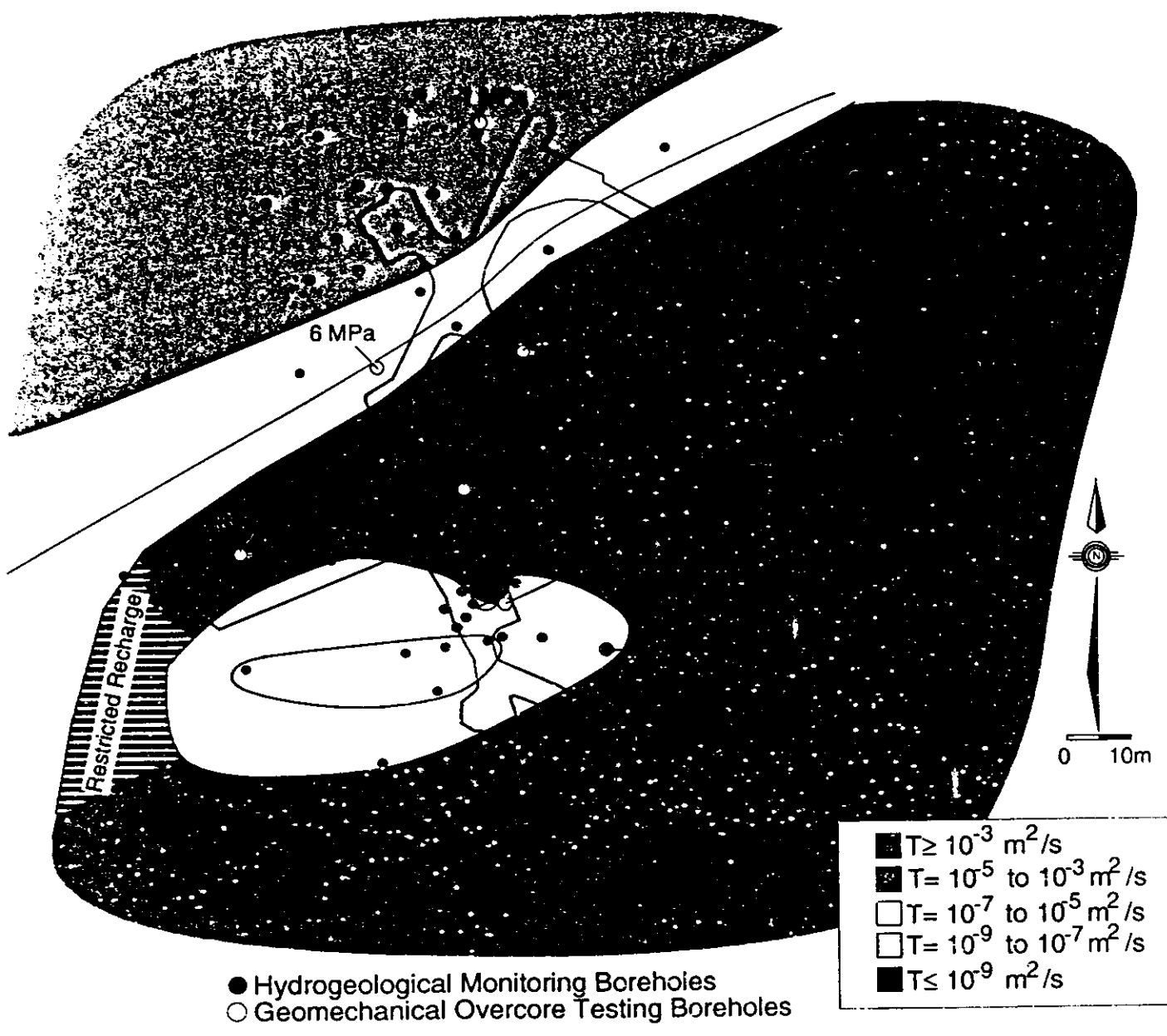

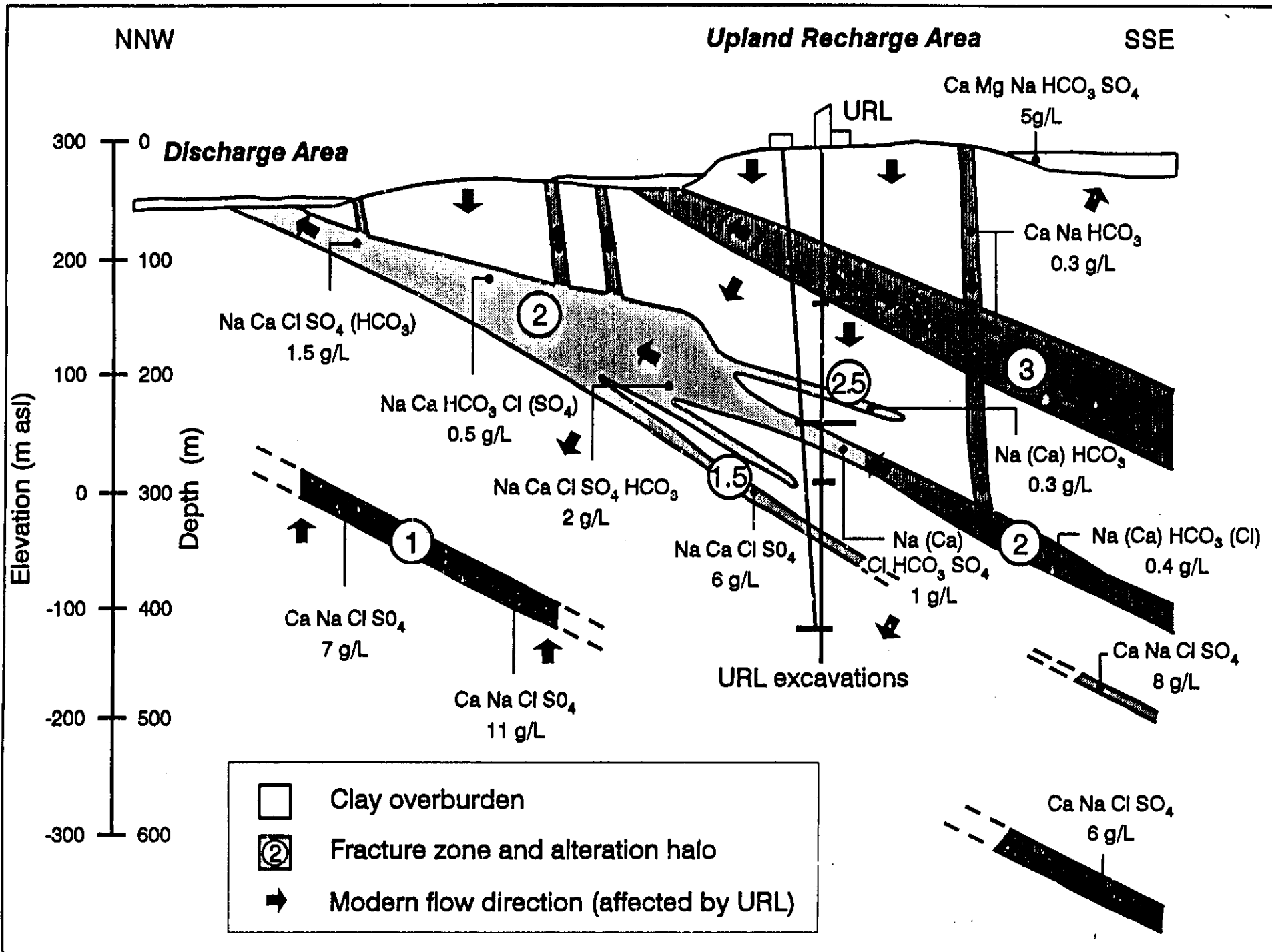

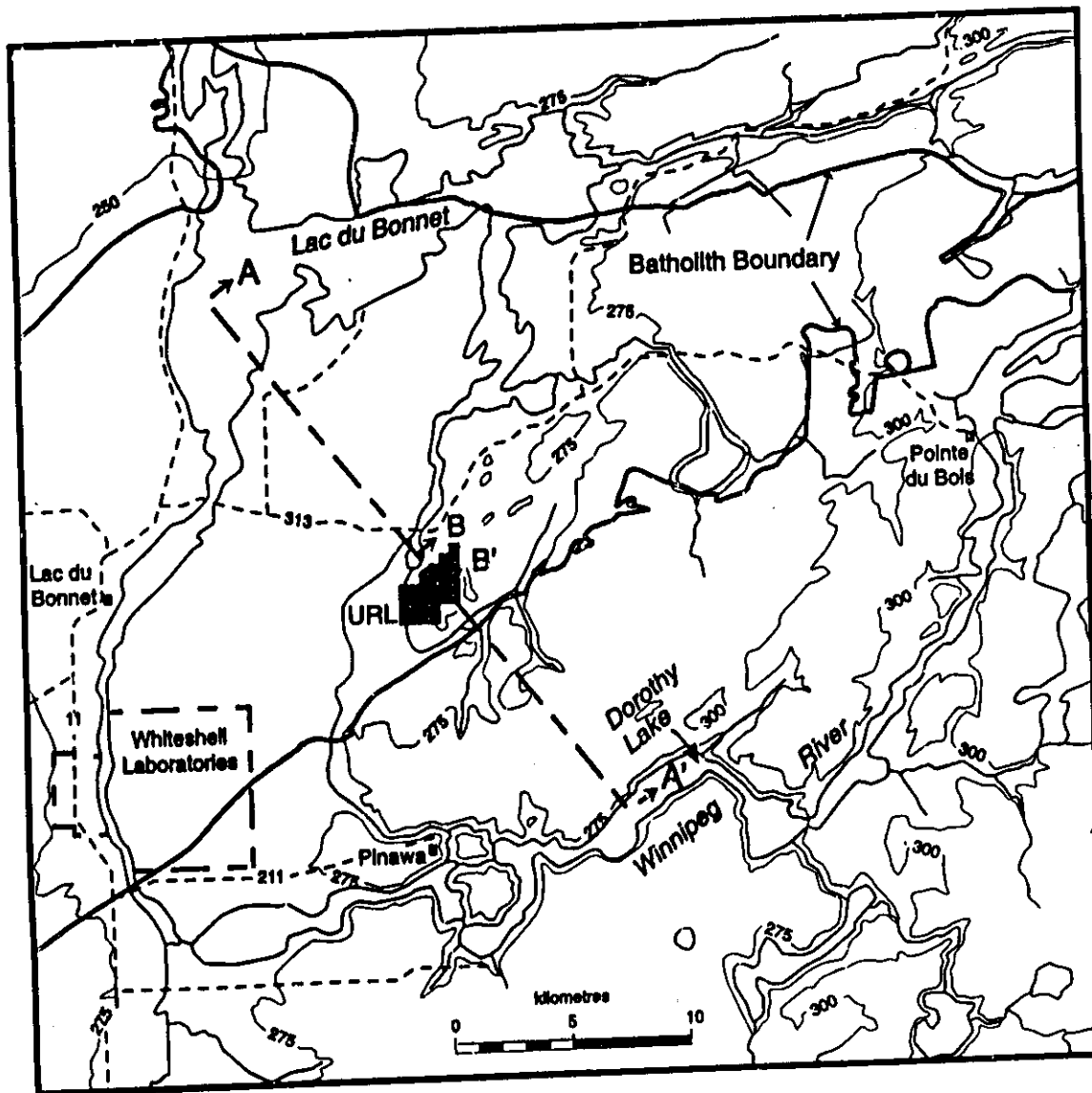

FIGURE 5.4.2: The Whiteshell Research Area showing the location of the two-dimensional numerical model, label AA'. This line is approximately along a regional groundwater flow line, i.e., there is little flow perpendicular to the plane.

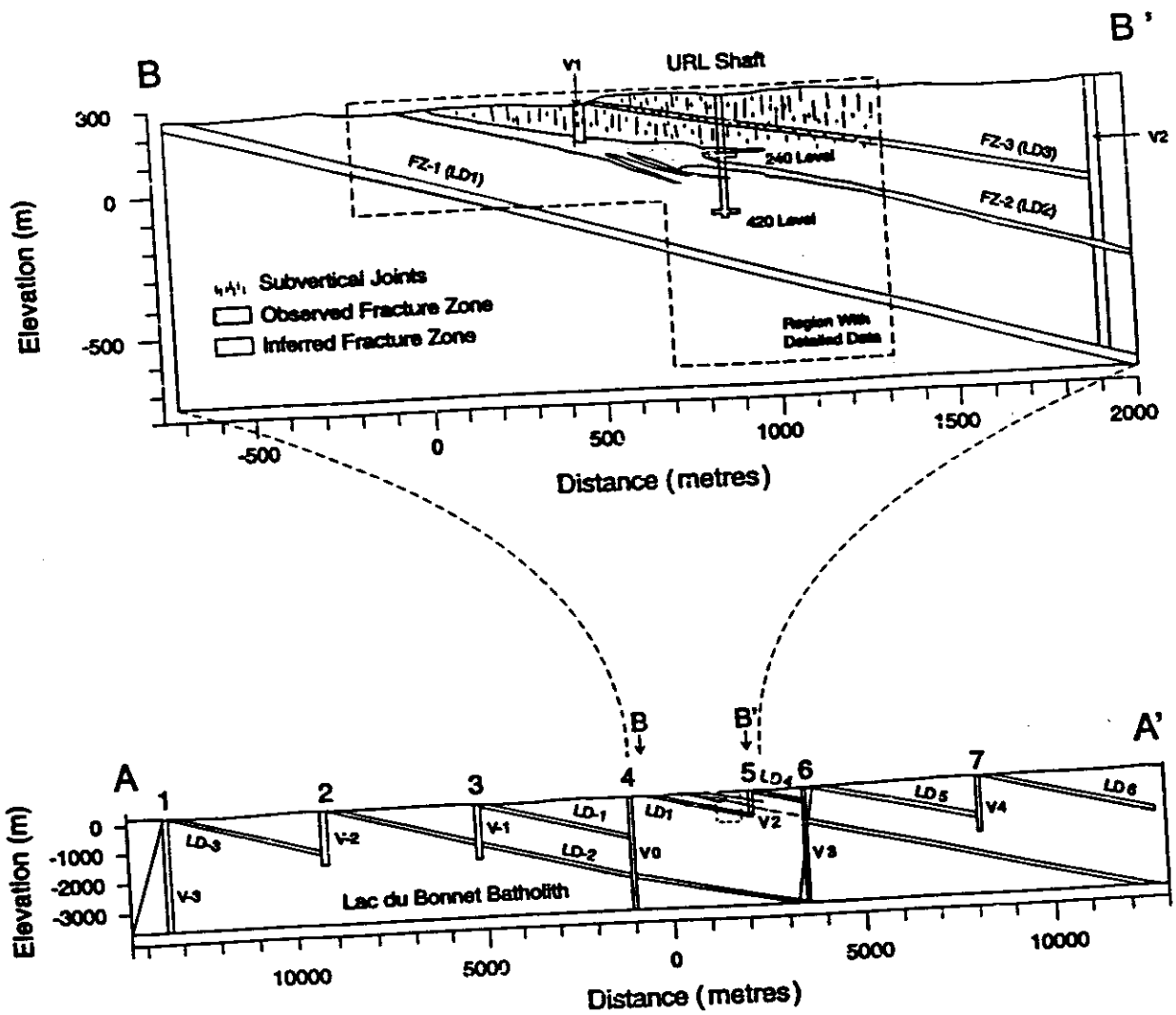
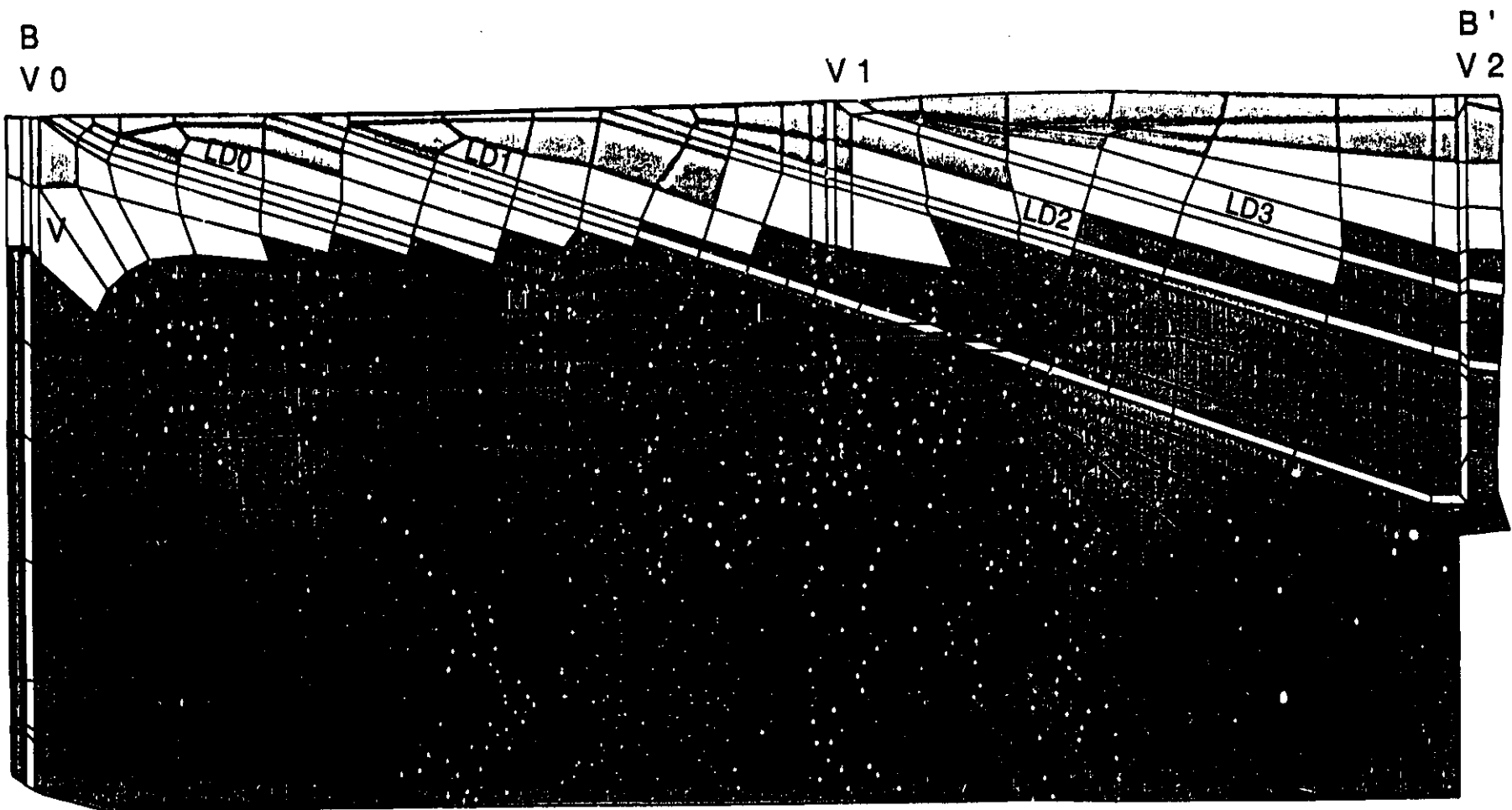
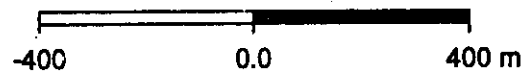

FIGURE 5.3.2: This figure illustrates in cross-section how the structural inferences from the region were combined with the conceptual model of the URL and how the geometry of the features in the conceptual model were regularized



— Vault

▬ Fracture zone



* Location Selected for Plots of Predicted Temperature and Velocity Versus Time

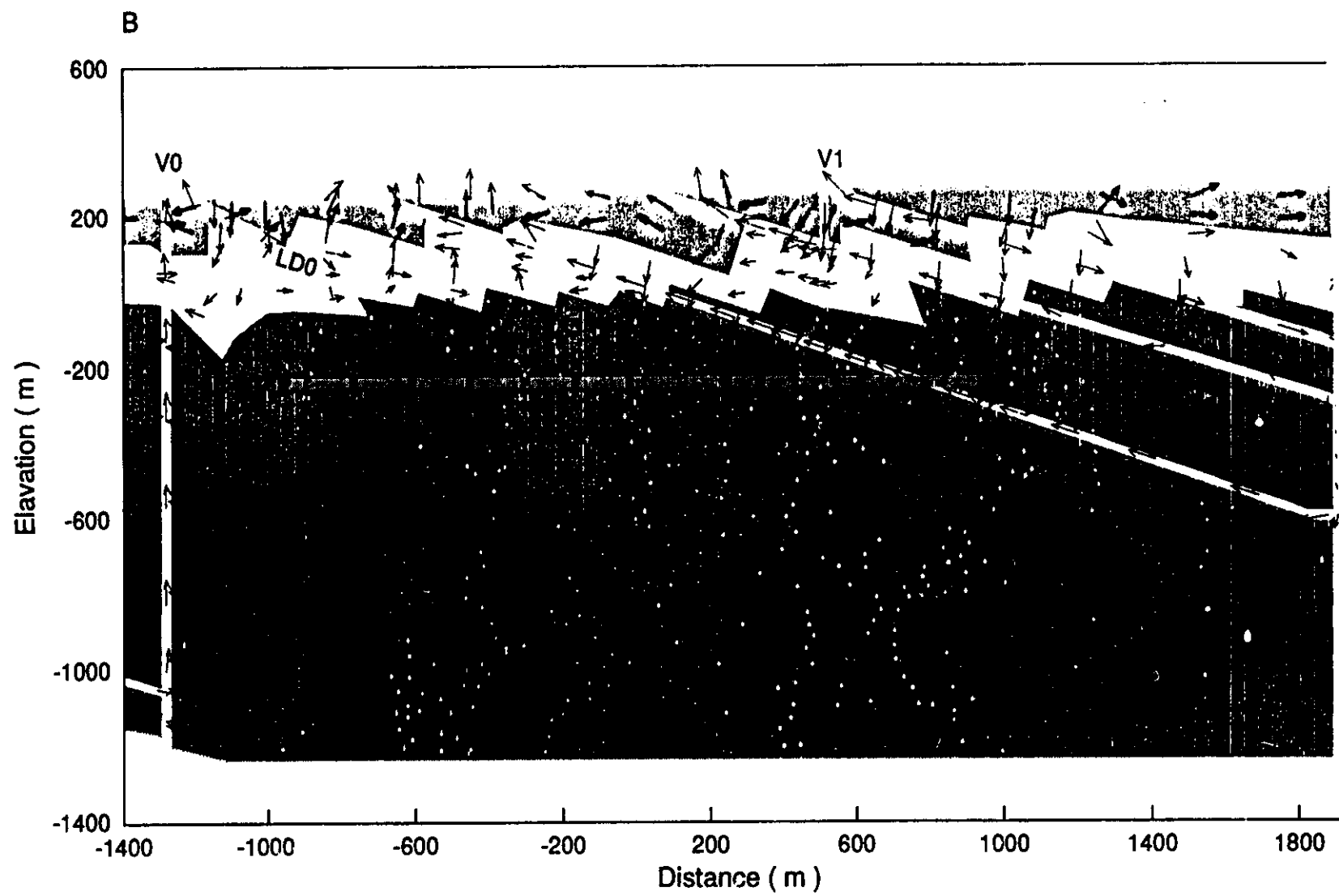

HYDROGEOLOGICAL ASPECTS:

- *HOST AREA SCREENING*
- *POTENTIAL CANDIDATE AREA EVALUATION*
- *CANDIDATE AREA CHARACTERIZATION*
- *FAVOURABLE CANDIDATE SITE CHARACTERISTICS*
- *CANDIDATE SITE CHARACTERIZATION*
- *RESEARCH AND DEVELOPMENT*



RESEARCH AND DEVELOPMENT:

- *IN-HOUSE VERSUS CONTRACTED TECHNICAL EXPERTISE*
- *ACADEMIC AND PRACTICAL TRAINING*
- *TOOL DEVELOPMENT*
- *NATIONAL AND INTERNATIONAL SUPPORT*



IN-HOUSE VERSUS CONTRACTED TECHNICAL EXPERTISE

SCIENTIFIC DISCIPLINES:

ENVIRONMENT;
GEOLOGY;
GEOPHYSICS;
HYDROGEOCHEMISTRY
HYDROLOGY;
HYDROGEOLOGY;
HYDRAULICS;
GEOMECHANICS
MATHEMATICAL MODELLING

DEVELOP BROAD HYDROGEOLOGICAL EXPERTISE BASE:

INTERNATIONAL CONSULTANTS;
THAI GOVERNMENT AGENCY STAFF;
THAI UNIVERSITY STAFF;
PRIVATE CONSULTANTS AND CONTRACTORS

SPREAD INVOLVMENT AND SUPPORT:

PROMOTES THAI RESEARCH AND DEVELOPMENT;
PROMOTES MUTUAL UNDERSTANDING AND TRUST;
PROMOTES INTERNATIONAL RESPECT

