

Electrical Systems - Course 135

INTRODUCTION TO SYMMETRICAL COMPONENTS & UNBALANCED CURRENTS1.0 INTRODUCTION

This lesson explains how unbalanced current problems can be solved using symmetrical components. This is done by:

- (a) explaining how the **symmetrical** components are derived for a three-phase system.
- (b) showing how **symmetrical** components are used to explain the components of currents in a line to ground (L-G) fault and in a line to line (L-L) fault.
- (c) explaining how and where they occur in a 3 phase system.

2.0 SYMMETRICAL COMPONENTS IN A THREE-PHASE SYSTEM2.1 Balanced Three-Phase Conditions

In three-phase systems, during normal balanced three-phase loading or during a balanced three-phase fault, equal currents flow in each of the three lines. This can be represented by the vectors shown in Figure 1 where rotation is R-W-B anti-clockwise.

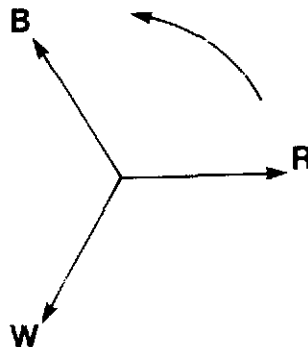

The current I in each line is found by

$$I = \frac{V_p}{Z_p}$$

where V_p is the phase voltage and Z_p is the phase impedance.

Figure 1: Balanced Three-Phase Currents.

2.2 Unbalanced Faults

When a line - ground (L-G) fault occurs or when a three-phase generator or supply has a single-phase load applied to it, the currents can be represented by Figure 2 where I_R is the current in the faulted red phase. The current in the healthy white and blue phases are zero, ie, $I_W = I_B = 0$.

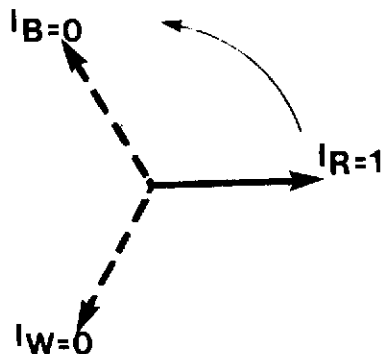

Figure 2: Vectors of Currents When a L-G Fault Occurs on Red Phase.

In this case, the current I_R cannot be found by

$$\frac{V_p}{Z_p}$$

because of the interaction of the other two phase in the generator. The problem was first investigated by Fortescue in the USA who noticed that the rotors of three-phase generators became excessively hot when they were supplying single-phase or unbalanced loads. This led to the investigation into the nature of unbalanced currents in three-phase circuits. A general theorem was produced which showed that, in the case of an unbalanced three-phase system, the current or currents could be resolved into three sets of components or vectors. Each set of vectors being equal in magnitude and displaced from each other by an equal angle. Because each set of the vectors is symmetrical in magnitude and angle they are called "symmetrical components". The theorem also states that the angle of displacement for the first set is 120° , the second set 240° and 360° for the third set. The three sets of vectors are shown in Figures 3(a), 3(b), and 3(c). (Reference 1.)

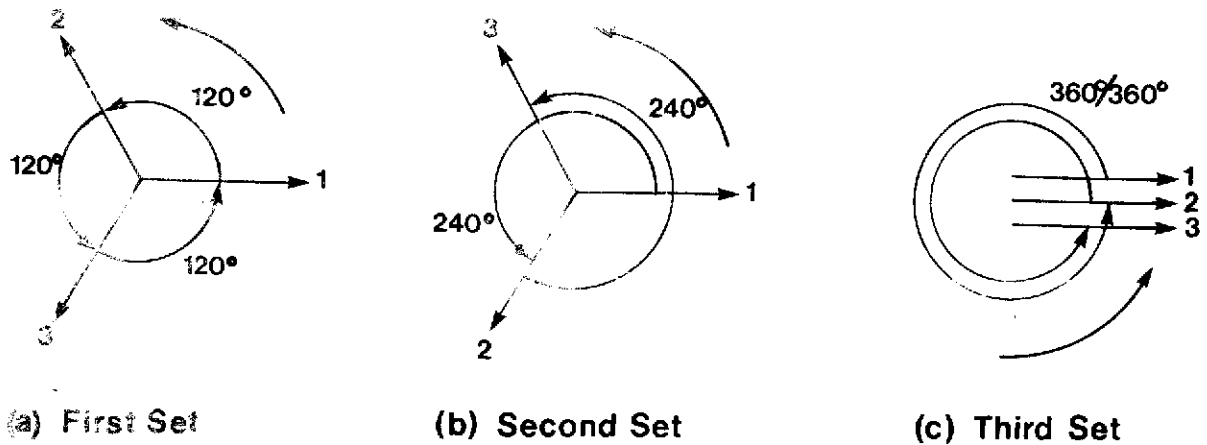

Figure 3: Symmetrical Component "Sets" for a Three-Phase System.

Applying the standard phase notation to the three symmetrical components sets gives:

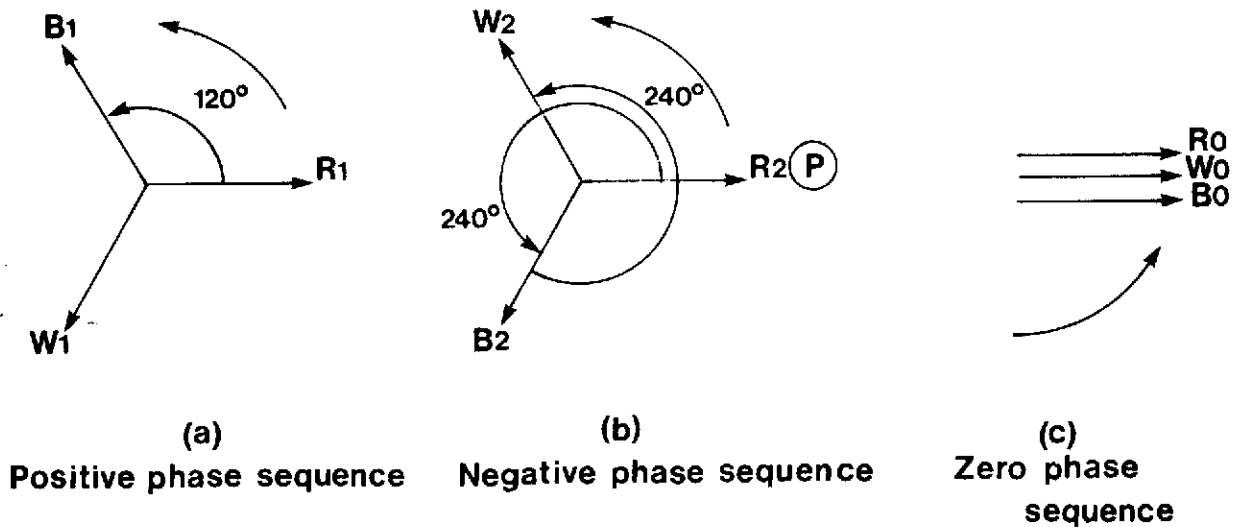

Figure 4: Symmetrical Components Sets and Their Standard Notations and for a Three-Phase System.

2.2.1 Positive, Negative and Zero Phase Sequences

(a) Positive Sequence. Figure 4(a) shows the standard RWB vectors rotating in the standard anti-clockwise rotation and is called **positive phase sequence**. Positive phase sequence components currents are given the subscript 1, ie, R_1 , W_1 , B_1 .

- (b) Negative Sequence. Figure 4(b) shows the vectors, when rotated in the anti-clockwise direction have the order RBW, ie, the vectors pass point (P) in the order RBW.

Another way of looking at Figure 4(b) is to interchange the W and B vectors and rotate them in a clockwise or negative direction. Figure 5 shows that when this is done, the vectors have the same RBW configuration as in Figure 4(a) but the direction is **reversed**. The vectors now pass point (P) in the order RBW. Because this direction is opposite to the positive sequence direction, the vectors are called **negative phase sequence** vectors. Negative sequence components of currents are given the subscript 2, ie, R_2 , W_2 , B_2 .

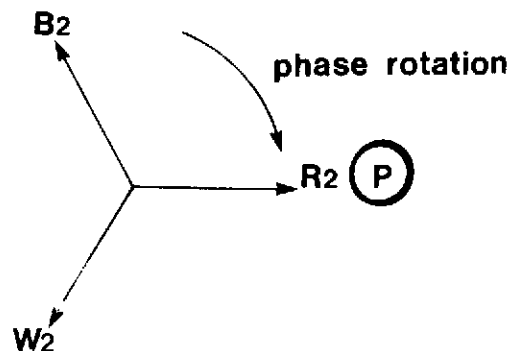

Figure 5: Negative Phase Sequence Vectors, RWB Clockwise.

- (c) Zero Phase Sequence. In the case of Figure 4(c), the vectors are all in phase and have 360° or effectively zero phase angle displacement between them and are, therefore, called **zero phase sequence** vectors. Zero phase sequence components of currents are given the subscript 0, ie, R_0 , W_0 , B_0 .

2.3 To Summarize

The unbalanced currents in a three-phase generator or supply can be resolved into three sets of symmetrical components of current, each set having the same magnitude. These symmetrical components of current are called "positive sequence", "negative sequence" and "zero sequence" symmetrical components of current.

3.0 ANALYSIS OF VARIOUS TYPES OF FAULTS3.1 Line to Ground Fault

Figure 6(a) shows a red line to ground fault. Figure 6(b) shows the current vector for this fault. It is assumed there is little or no load current. Current flows in R line and no current flows in W or B lines. Figure 6(c) shows the standard positive, negative and zero components of current. Figure 6(d) shows how R-N line current I_R is made up from equal quantities of positive, negative and zero phase sequence components of current. The white and blue line currents resolve to zero.

(a) Red Line to Ground Fault.

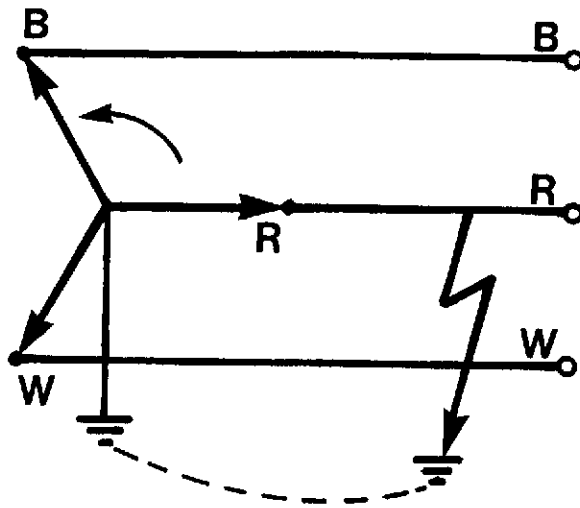

(b) Current Vectors for the Above.

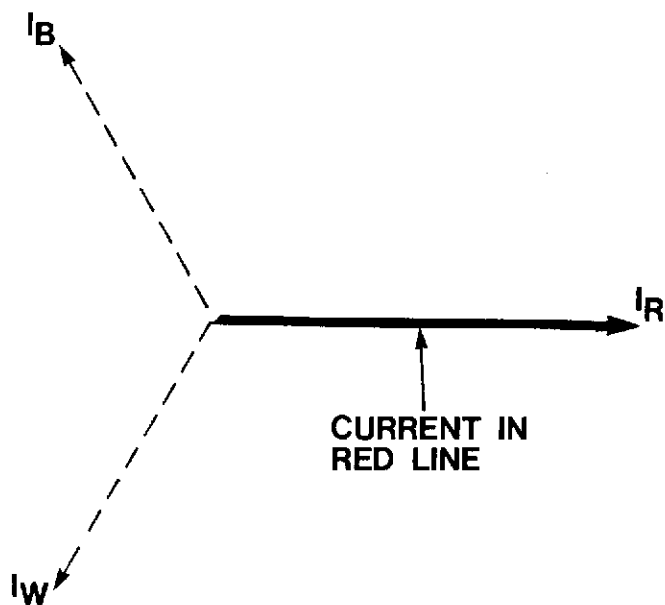

Figure 6

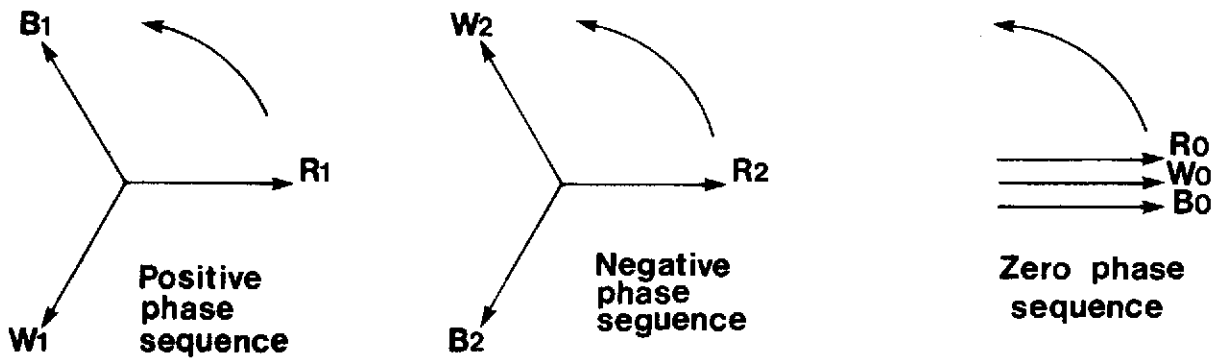

Figure 6(c): Positive, Negative and Zero Components of current.

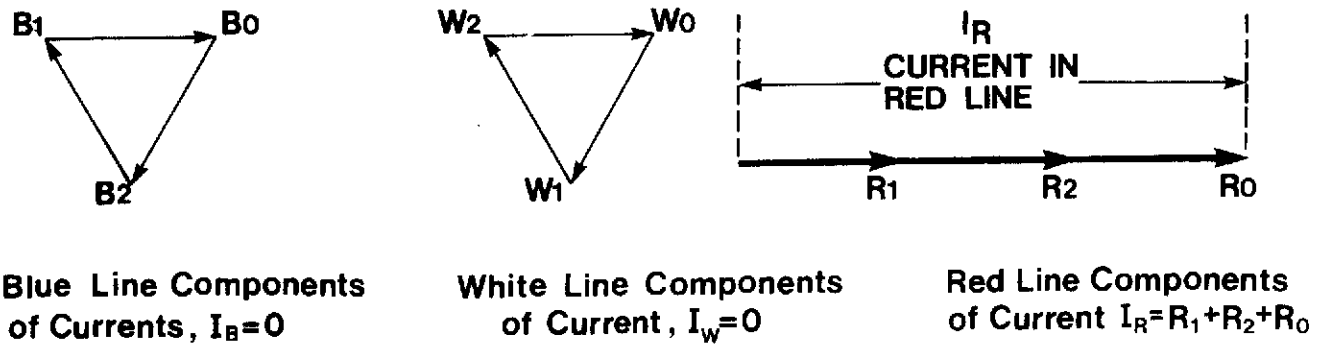

Figure 6(d): Vectors showing how the current in red line is made up from equal quantities of red positive, red negative and red zero phase sequence components of current. White and Blue line currents resolve to zero.

3.2 Line to Line Fault

Figure 7(a) shows a white to blue line to line fault. Figure 7(b) shows the current vectors for this fault. It is assumed there is little or no load current.

Note that because the current flows out from the white terminal and into the blue terminal, there is a 180° displacement between the currents in the white and blue lines.

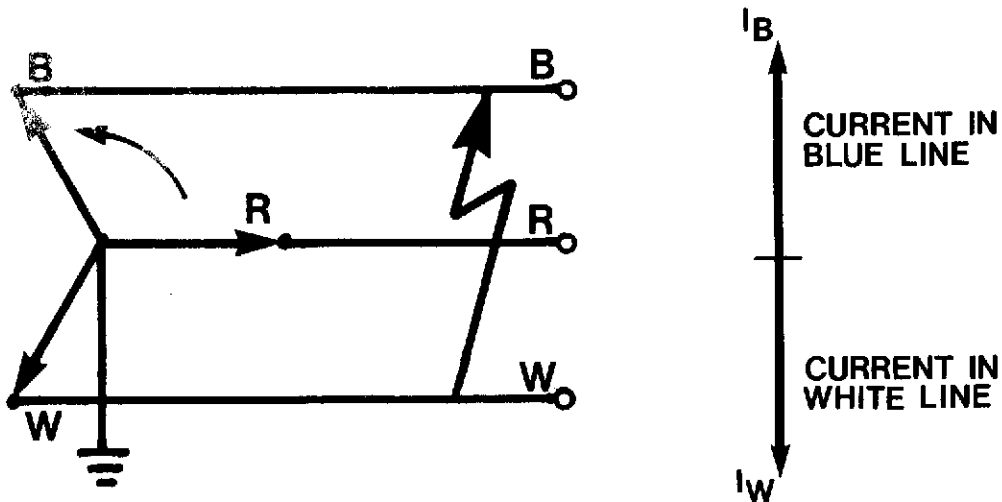

Figure 7(a): W-B Line Fault.

Figure 7(b): Currents Associated with a W-B Line to Line Fault.

Once again, **symmetrical** components can be applied to analyze the currents. Positive and negative sequence components will occur as before, but for zero sequence currents to flow, there must be a return path for the currents, ie, they must have a neutral in which to flow. Because there is no neutral connection when a L-L fault occurs, there can be no zero phase sequence component of current. In fact, zero sequence currents only occur when ground fault current flows.

Figure 8 shows how the W-B fault current in a L-L fault is made up from the components of equal quantities of positive and negative sequence currents. The components of red phase currents resolve to zero. The vectors of R_1 and R_2 current are 180° to each other. This fact is explain in symmetrical component theory. (Reference 2.)

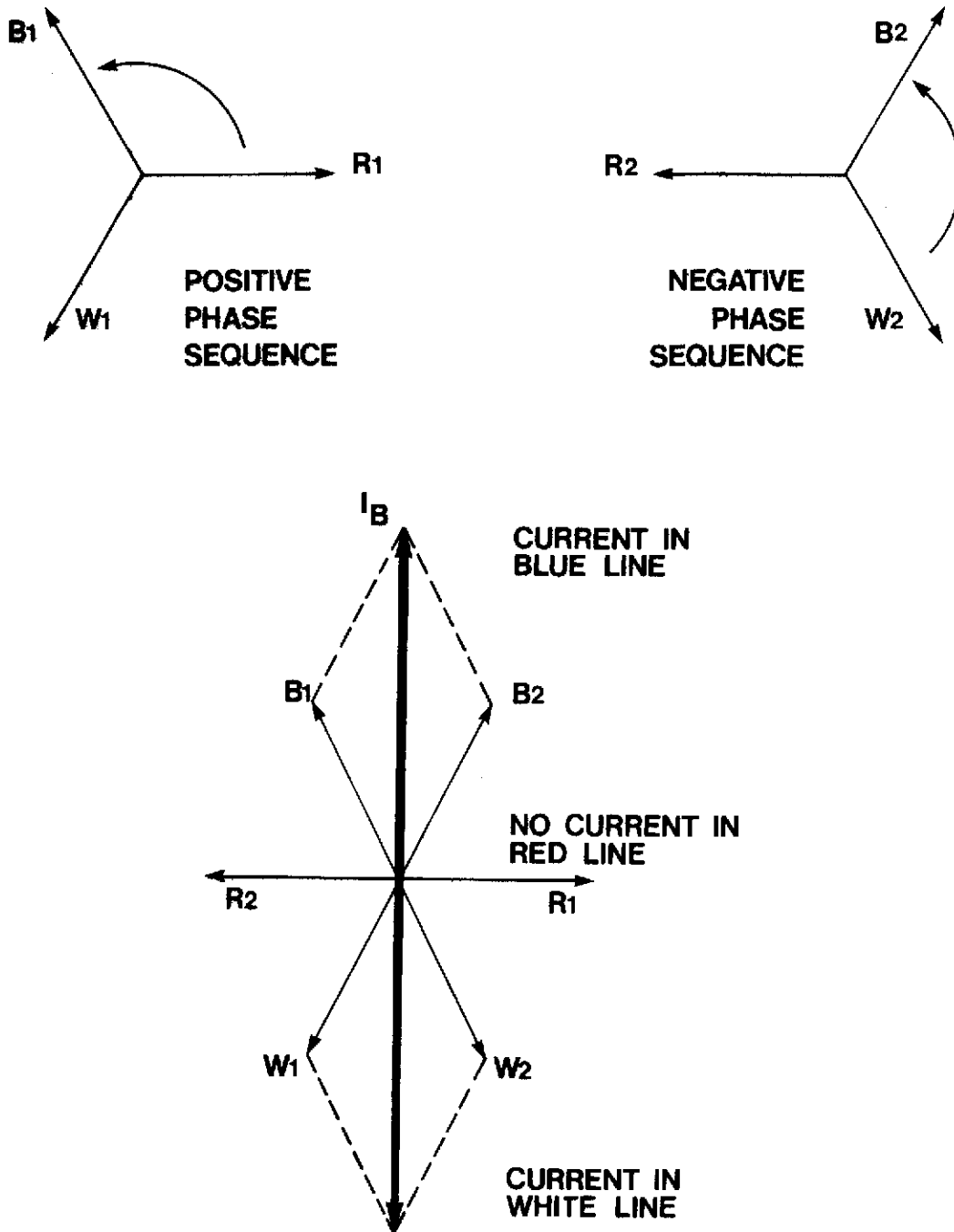

Figure 8: Diagram showing how the currents in a W-B, L-L fault are made up from the components of positive and negative sequence currents. The components of red phase current resolve to zero.

5.0 SYMMETRICAL COMPONENTS APPLIED TO OTHER TYPES OF FAULT

When faults or unbalances occur which are not of the simple L-G or L-L types, the nature of the currents can still be resolved by the use of symmetrical components. The subject is covered in detail in textbooks. (Reference 2.) It should be appreciated that with three phase systems:

- (a) when balanced conditions occur, only positive sequence currents flow.
- (b) zero sequence currents only occur when there is a ground fault, ie, L-G or L-L-G.
- (c) positive and negative sequence currents occur with all unbalanced conditions.

6.0 REFERENCES

Reference 1: J.R. Mortlock and Humphrey Davis, "Power System Analysis" Page 53. Chapman and Hall.

Reference 2: J.R. Mortlock and Humphrey Davies "Power System Analysis" Page 68. Chapman and Hall.

ASSIGNMENT

1. State the relationships between positive, negative and zero phase sequence currents when the following faults occur:
 - (a) Line-to-line-to-line (L-L-L)
 - (b) Line-to-ground (L-G)
 - (c) Line-to-line (L-L)
2. Explain how, when a line-to-ground (L-G) fault occurs, equal quantities of positive, negative and zero sequence currents are produced.
3. Explain how, when a line-to-line (L-L) fault occurs, equal quantities of positive and negative sequence currents are produced. Also, explain why no zero sequence currents occur with this type of fault.

J.R.C. Cowling