

Chapter 3 Nodalization

3.1 Introduction

3.1.1 Chapter content

This chapter focusses on establishing a rationale for, and the setting up of, the geometric representation of thermalhydraulic systems.

The hydraulic network is represented by a series of interconnected nodes to form a node-link diagram.

3.1.2 Learning Outcomes

| | | | | | | |
|--------------------|---|---------------|-------------|----------|-----------|------------|
| Objective 3.1 | The student should be able to develop, with justification, a node-link diagram given a thermalhydraulic system. | | | | | |
| Condition | Open book written or oral examination. | | | | | |
| Standard | 75%. | | | | | |
| Related concept(s) | Node-link diagram. | | | | | |
| Classification | Knowledge | Comprehension | Application | Analysis | Synthesis | Evaluation |
| Weight | a | a | a | | | |

| | | | | | | |
|--------------------|--|---------------|-------------|----------|-----------|------------|
| Objective 3.2 | The student should be able to construct the matrix form of the conservation equations for a given node-link structure. | | | | | |
| Condition | Open book written or oral examination. | | | | | |
| Standard | 75%. | | | | | |
| Related concept(s) | Matrix form of the conservation equations. | | | | | |
| Classification | Knowledge | Comprehension | Application | Analysis | Synthesis | Evaluation |
| Weight | a | a | a | | | |

3.1.3 Chapter Layout

The exploration proceeds by

establishing and discussing the governing rationale,

presenting limitations of the approximation,

giving examples,

introducing the matrix approach to capture the system geometry in a succinct form.

3.2 The Node-Link Concept

We had for

an arbitrary volume, i ,

with material flow through various surfaces, designated by the subscript j

(see figure 3.1):

$$\frac{\partial M_i}{\partial t} = \sum_j \rho_j v_j A_j \equiv \sum_j W_j, \quad (1)$$

$$\frac{\partial W}{\partial t} = \frac{A}{L} \left[(P_{IN} - P_{OUT}) - \left(\frac{fL}{D} + k \right) \frac{W^2}{2g_c \rho A^2} \right] - A \rho g/g_c \sin(\theta) \quad (2)$$

$$\frac{\partial H}{\partial t} = + \sum W_{IN} h_{IN} - \sum W_{OUT} h_{OUT} + Q \quad (3)$$

EQUATION ASSIGNMENT

These mass and energy equations are averaged over the volume in question, hence they do not capture any detail within the volume.

Knowing the mass and energy of a volume, the equation of state gives the pressure.

Flow, however, is driven by pressure differences.

Hence it naturally follows that the momentum equation should be applied between the points of known pressure, ie, between volumes.

In the distributed approach, this is called the staggered grid method.

In the lumped approach, it is called the node-link method and is illustrated in figure 3.2.

Volumes are represented by nodes, flow paths are represented by links.

NODE-LINK ASSIGNMENT

To assign nodes and links to a given piping configuration, say the simple pipe of figure 3.3, it is best to first focus on the flow modelling.

The key question to ask is: Where should the link endpoints (ie the node centres) be placed?

The node centre locations define the positions at which the pressure will be evaluated and this is important for correct flow calculations.

For constant area pipes, the placement is not critical but at junctions and area changes, modelling is simplified if node centres are placed at junctions and pipe area changes.

For the case shown in figure 3.4 (a), if the flow were going from left to right and the junction resistance were included in link 1, then the pressure at node 2 would be the pressure just downstream of the junction.

If possible, avoid running links across area changes since this inserts ambiguity into the flow area of the link model, as illustrated in figure 3.4 (b).

LINK RESISTANCES

Hydraulic friction can be affected by flow direction.

Figure 3.4 illustrates a simple pipe flow situation wherein there is a step change in area. Flow from left to right experiences a different junction resistance than flow going from right to left.

Direction dependent resistances are usually modelled explicitly in the system codes. The momentum flux terms, $A\rho v^2$, can either be modelled explicitly or through the resistance coefficient, k .

Note that a simple force balance around the junction would show that there is a net lateral force on the pipe. This force imbalance would have to be accounted for by a body force if different inlet and outlet pipe areas were used.

This is another reason that links are chosen to coincide with constant pipe length sections.

LINK PROPERTIES

The properties of the fluid within the link are a result of the properties of the upstream node.

As the fluid is transported along a flow path (ie along the link), the link properties will change over time.

Naturally there will be a transport delay but given that the nodal properties are themselves average values that change relatively slowly over time, system simulation codes typically assume that the link properties are just the same as the upstream nodal properties.

For most purposes this is an acceptable assumption that can be lessened by using more nodes and links in the model.

One has to be careful, however, of flow reversal situations that involve two-phase flow since this can lead to rapid and large density changes in the link.

NODE LOCATION AND SIZE

The node volume is usually assigned as the fluid surrounding the node centre as shown in figure 3.4(a).

But this is not a critical assignment; the node “centres” can actually be at the edge of the volume if that proves convenient.

From a numerical point of view, it is beneficial to divide the hydraulic network up into volumes of roughly equal size since the properties in small volumes can change very rapidly and thus force the use of correspondingly small time steps.

This rationalization of the volume assignments may force the user to take some liberties with the notion of a node “centre”.

RECAP

The momentum equation is used to solve for W_j in all links, driven by upstream and downstream pressure differences and retarded / accelerated by friction, elevation change, pumps, etc. that appear in the links.

This flow transports mass and energy to and from the nodes.

Local heat sources and sinks, such as surface heat fluxes, are modelled at the nodes.

3.3 Nodal Diffusion

In the node - link representation of flow in a pipe, no flow detail is considered as the fluid moves along the pipe. Therefore, no diffusion, dispersion, advection, flow profiles or flow regimes are explicitly permitted.

This is not too crude an approximation for the calculation of pressure drops and flows.

But for modelling the propagation of disturbances, this approach is inadequate as it stands unless a large number of nodes and links are used.

Consider a homogeneous or bubbly flow through a pipe, as in the two-phase regions of typical heat transport systems, modelled in system codes as nodes connected by links.

Perfect mixing at the nodes is assumed.

Flow in a pipe, however, has aspects of plug flow.

Figure 3.5 shows how the discontinuity would move in time and space. The left to right movement is due to the velocity, v , while the spreading out is due to diffusion.

If a single mixing tank (node) represented a section of pipe of volume, $V \text{ m}^3$, and volumetric flow, $f \text{ m}^3/\text{s}$, then a step change to zero in a field property, C , (which could be concentration or density) entering the node would be an exponential by the time it left the node, that is:

$$C_{OUT} = C_{IN} e^{-\frac{t}{\tau}} \quad (4)$$

where $\tau = V/f$; τ is also the transmission time for the plug flow model.

If the pipe were modelled by two nodes in series,

$$C_{OUT \text{ NODE} 2} = C_{IN \text{ NODE} 1} \left(1 + \frac{2t}{\tau}\right) e^{-\frac{2t}{\tau}} \quad (5)$$

and in general, for n nodes:

$$C_{OUT \text{ NODE} 2} = C_{IN \text{ NODE} 1} e^{-\frac{nt}{\tau}} \sum_{k=1}^N \left(\frac{nt}{\tau}\right)^{k-1} \frac{1}{(n-1!)} \quad (6)$$

Figure 3.6 compares the transmission of a step change for various numbers of nodes and the plug flow model.

It is easy to see why the codes model void propagation poorly:

A very large number of nodes are needed to transmit a disturbance without appreciable distortion.

The phase relationships or timing, of the propagation is very important in determining the stability of a thermal hydraulic system.

A pocket of void reaching a given destination at an earlier or later time may enhance or cancel the phenomenon in question.

The smearing of a wave front alters the timing and gain and hence affects stability.

The slow convergence of the mixing model to the plug flow model explains the typically slow convergence of such system codes as more nodes are added to increase accuracy.

Thus, nodalization creates a form of diffusion in much the same manner as finite difference schemes create numerical diffusion (see, for instance, Roache [10]).

Attaining convergence in nodalization is, in essence, converging the model to plug flow behaviour.

But is the flow in typical heat transport systems plug flow?

Flow in the CANDU feeders (38 to 76 mm) at 15 M/sec may indeed be plug flow. But some turbulent mixing does take place.

More importantly, the feeders are of varying length and the flow has a spectrum of qualities. This gives quite a spectrum in transit time.

This will skew the propagation of a disturbance as illustrated in figure 3.7. T

hus, depending on the transit time spectrum, a 5 node approximation (say) may be quite a good representation.

3.4 Examples

Figure 3.8, a simple Tee junction.

Note that each link has a unique junction resistance associated with the flow path of that link.

Note also that a link has a unique upstream node and a unique downstream node.

Links are always terminated by nodes at either end; in effect, the nodes provide boundary conditions for the links.

There are 2 nodes per link, no more, no less.

A node, on the other hand, can have many links connected to it.

The Y junction of figure 3.9 has a node link structure that is identical to the Tee junction. The differences in the two types of junctions are captured in the details of the correlations for friction, flow regimes, etc.

Figure 3.10 shows a CANDU HTS header and connecting piping.

Note that there is no best or unique node-link representation. The requirements of the problem at hand dictates the number of nodes and links and the layout of the representation.

For instance, it is useful to place a node centre at the point of a pressure measuring device so that experimental data can be more readily compared to the simulation results.

Figures 3.11 and 3.12 show typical nod-link diagrams for a CANDU Heat Transport System simulation.

3.5 Matrix Notation

As we shall see, it is sometimes expedient to cast the governing equations in matrix form.

To illustrate, consider the node-link network of figure 3.13.

Nominal flow directions are assigned to be positive in the normal flow direction.

The mass balance equations for the 4 nodes are:

$$\begin{aligned}\frac{dM_1}{dt} &= -W_1 + W_4 \\ \frac{dM_2}{dt} &= +W_1 - W_2 + W_5 \\ \frac{dM_3}{dt} &= +W_2 - W_3 \\ \frac{dM_4}{dt} &= +W_3 - W_4 - W_5\end{aligned}$$

(7)

If we define $\dot{M}_i \equiv \frac{dM_i}{dt}$ then the mass balance equations can be written

$$\begin{pmatrix} \dot{M}_1 \\ \dot{M}_2 \\ \dot{M}_3 \\ \dot{M}_4 \end{pmatrix} = \begin{pmatrix} -1 & 0 & 0 & +1 & 0 \\ +1 & -1 & 0 & 0 & +1 \\ 0 & +1 & -1 & 0 & 0 \\ 0 & 0 & +1 & -1 & -1 \end{pmatrix} \begin{pmatrix} W_1 \\ W_2 \\ W_3 \\ W_4 \\ W_5 \end{pmatrix} \equiv \dot{\mathbf{m}} = \mathbf{A}^{MW} \mathbf{w} \quad (8)$$

where

\mathbf{A}^{MW} is a 4x5 matrix

number of rows = number of nodes $N=4$,

number of columns = number of links $L=5$

\mathbf{w} is the flow vector.

Generally, upper case bold will be used to indicate a matrix and lower case bold will be used to indicate a vector. The superscript MW denotes that the matrix relates to the mass equation and to the flow vector. It also indicates the size of the matrix (nodes x links)

There can be up to L entries in a row

But only 2 entries in any column - no more, no less.

The A^{MW} matrix uniquely defines the geometry.

The matrix is most easily constructed on a column by column basis, ie on a link by link basis: for each link (column vector) place a -1 in the location of the upstream node and a +1 in the location of the downstream node.

As we shall see, all other matrices that arise in the solution to the mass, momentum and energy equations can be derived from the structure of A^{MW} .

This is very handy for computer coding purposes.

3.6 Exercises

1. For the 4 node, 5 link example of section 3.4, write out the flow and enthalpy equations as individual equations and in matrix form. Compare the structure of A^{WP} and A^{HW} to A^{MW} , where the superscript WP denotes that the matrix relates to the flow equation and the pressure vector, and the superscript HW denotes that the matrix relates to the enthalpy equation and the flow vector.
2. For the case of 2 connected, open tanks of water with surfaces at different elevations, set up the node-link diagram and the mass, momentum and enthalpy equations.
3. What would be different if the tanks in question 2 were closed?
4. Set up a node-link diagram for a simple research reactor loop as shown in figure 2.5. Write out the conservation equations for this case.

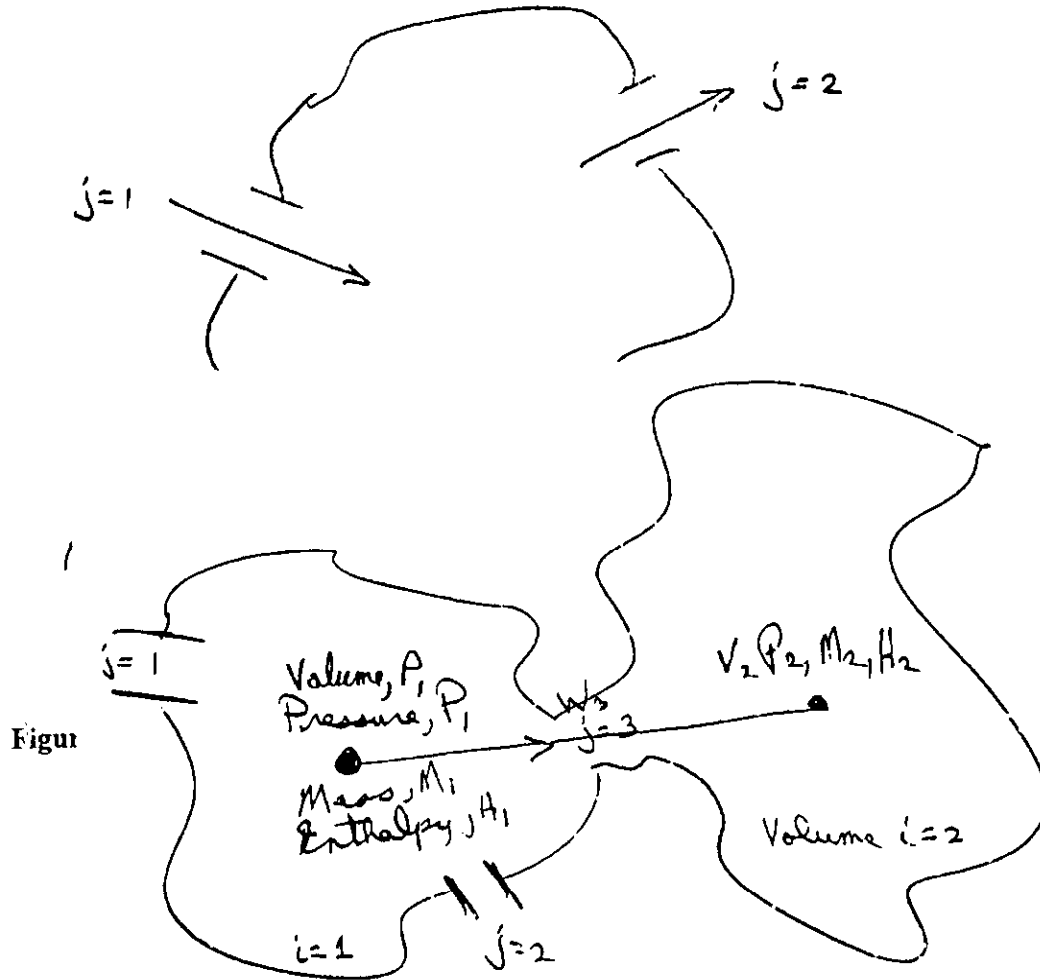

Figure 3.2 Two connected nodes.

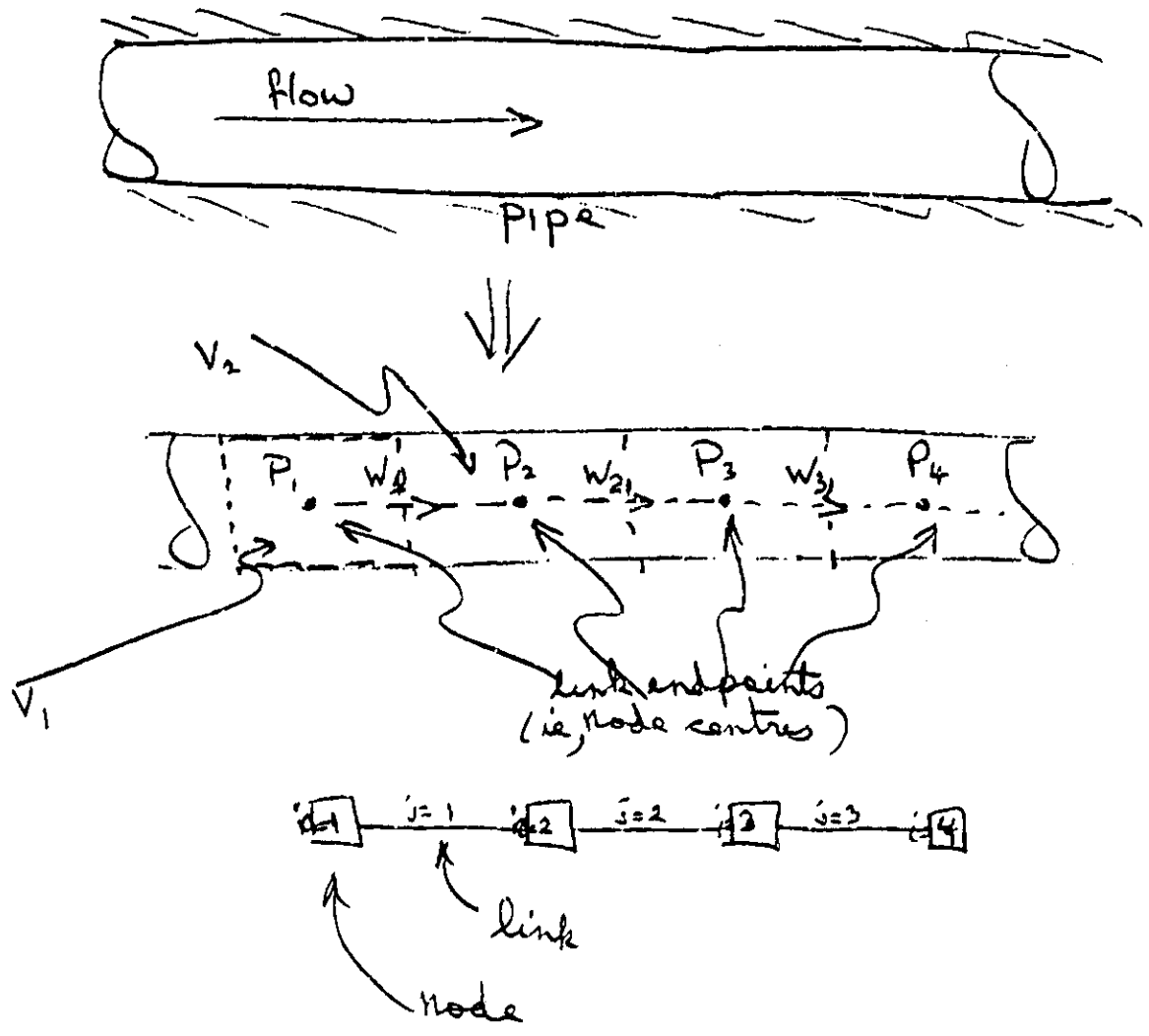

Figure 3.3 Node-link setup for a simple pipe.

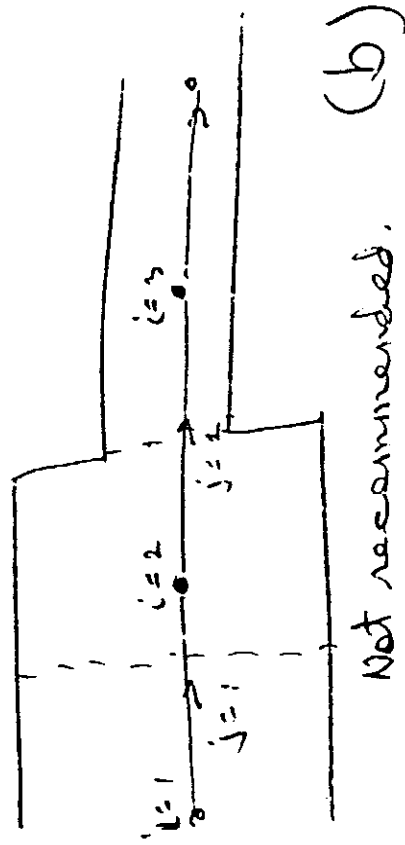
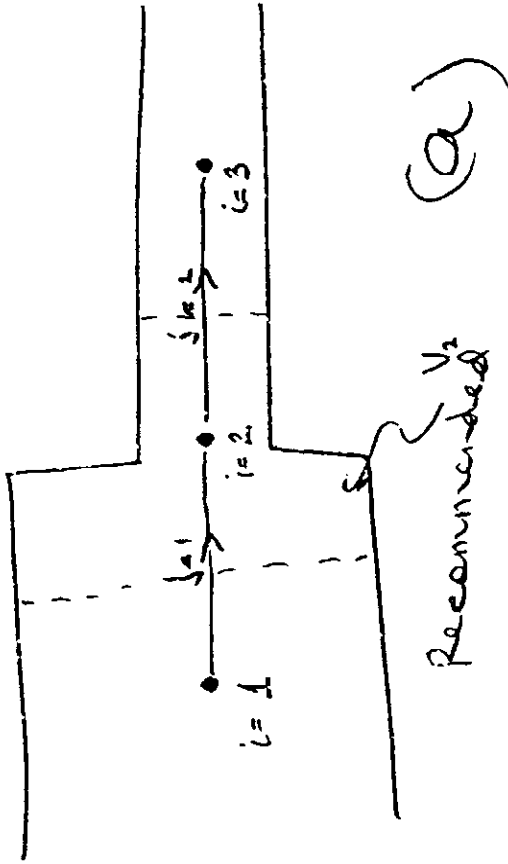

Figure 3.4 Node-link setup for an area change in a pipe.

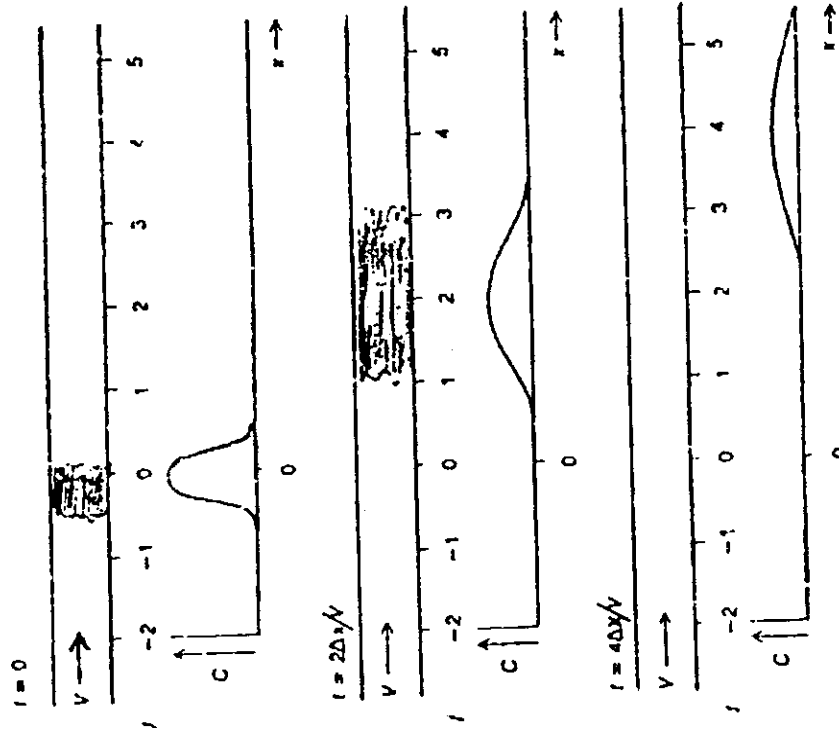

Figure 3.5 Illustration of convection and diffusion.

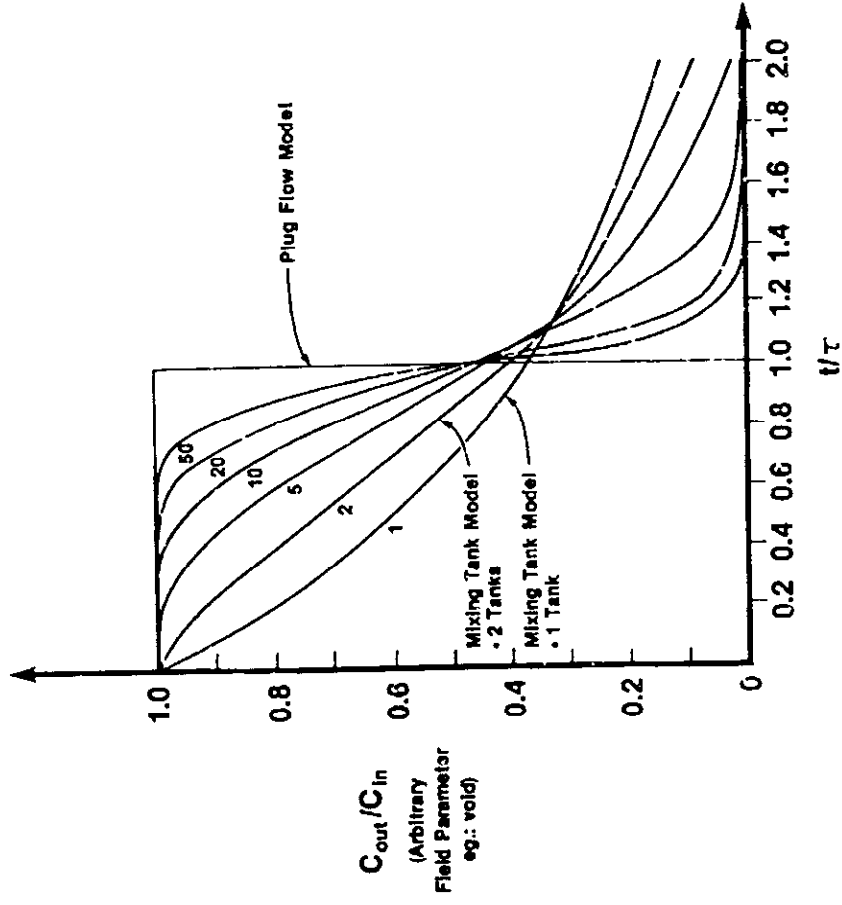

Figure 3.6 Transmission of a step change using the Plug Flow model and the Mixing Tank model (1 to 50 tanks).

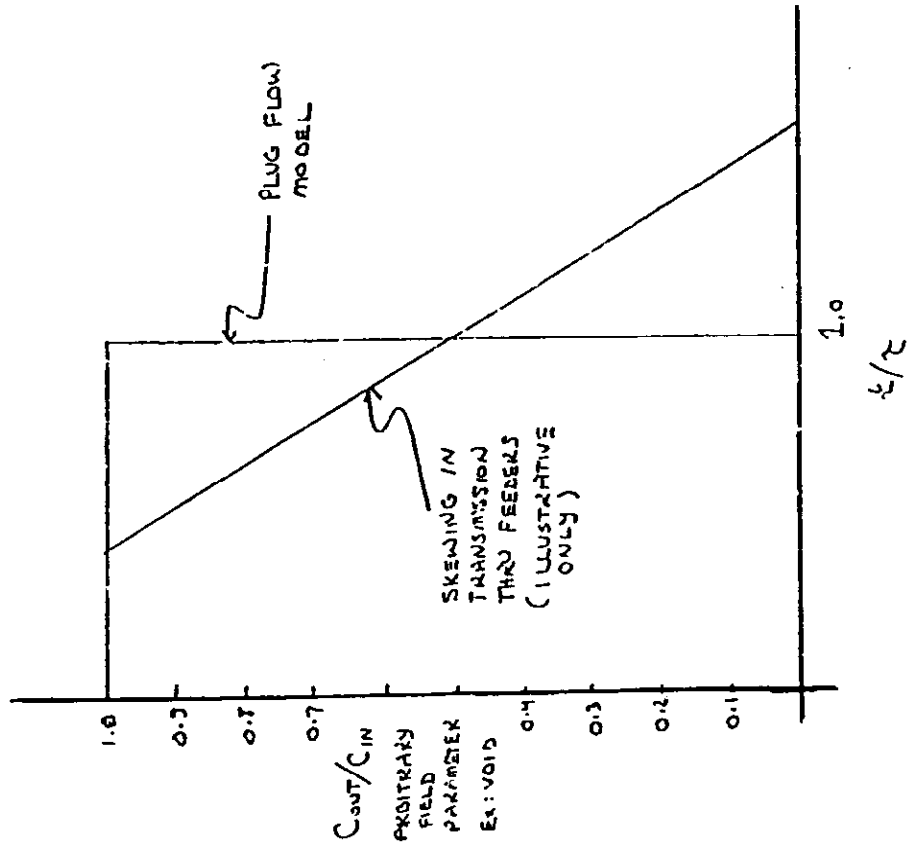

Figure 3.7 Transmission of a step change using the plug flow model and a feeder model with skewing due to differences in transit times.

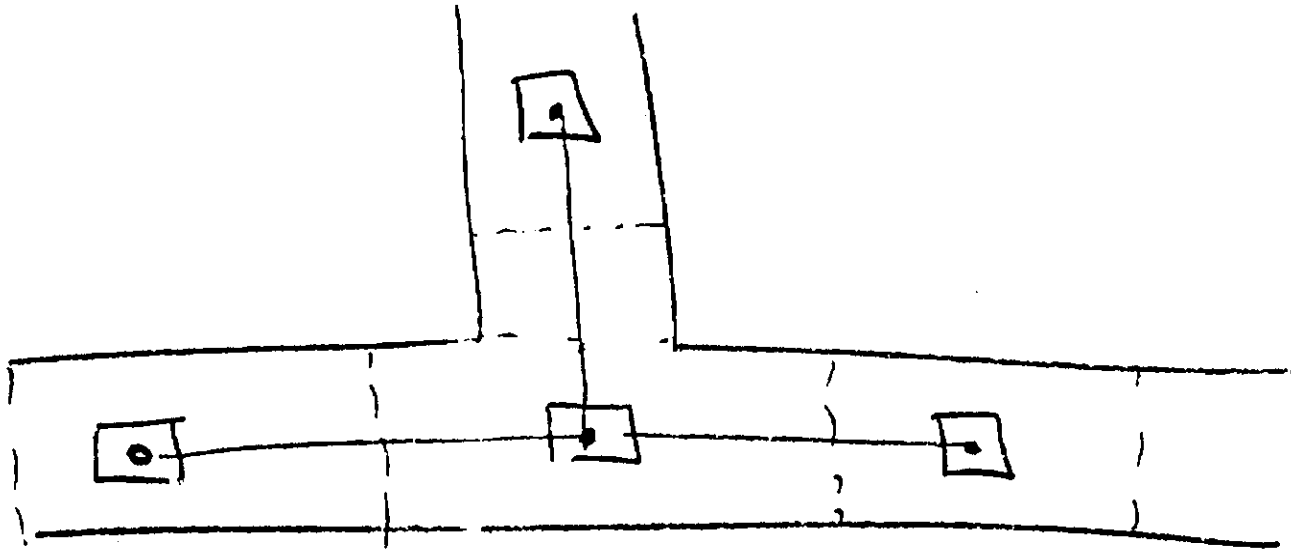

Figure 3.8 Simple Tee junction.

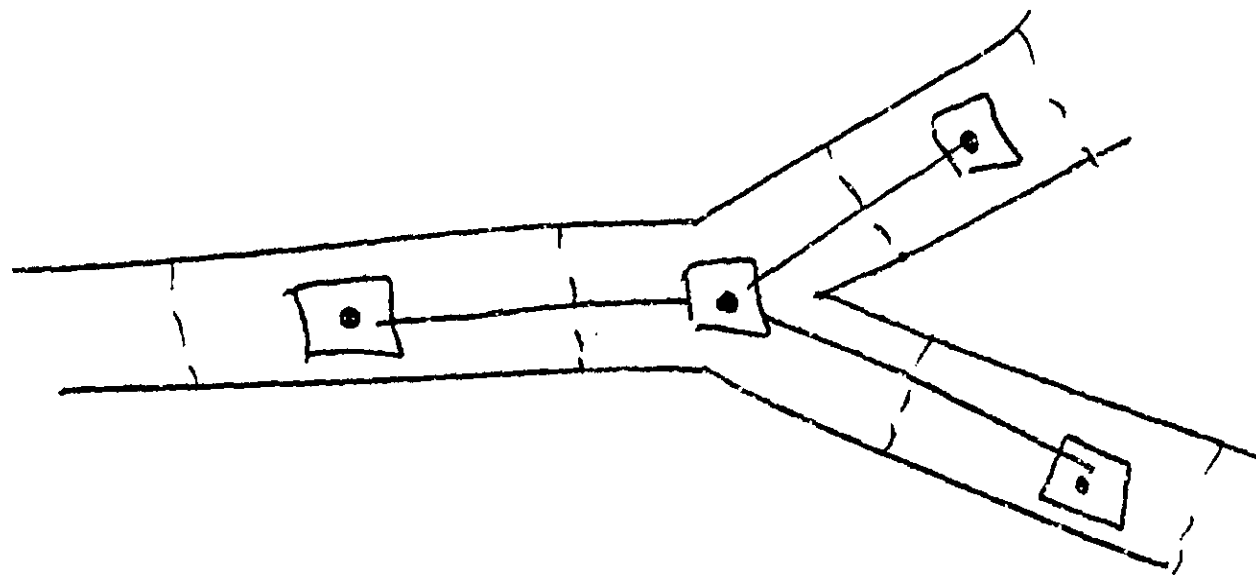

Figure 3.9 Simple Y junction.

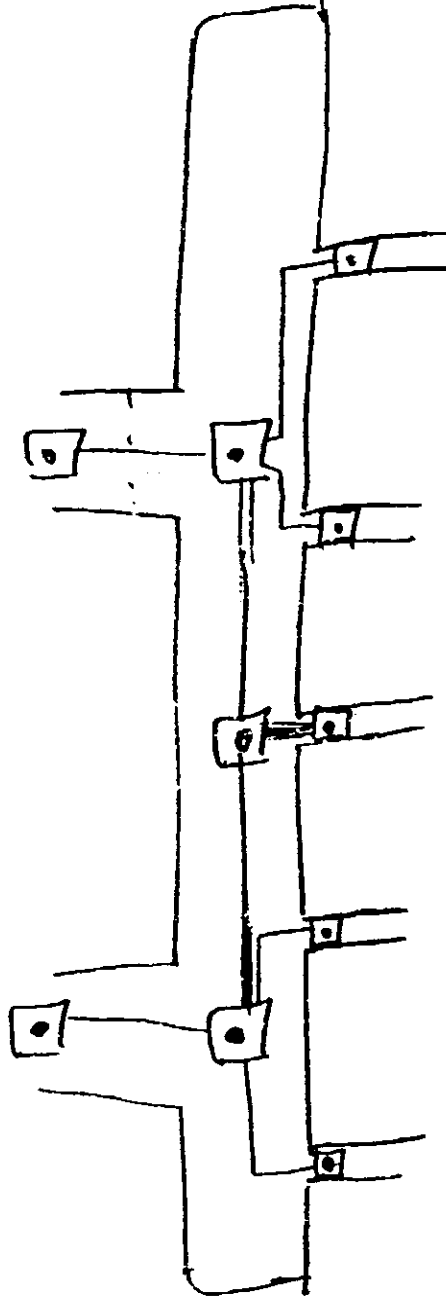

Figure 3.10 Sample node-link connections for a header.

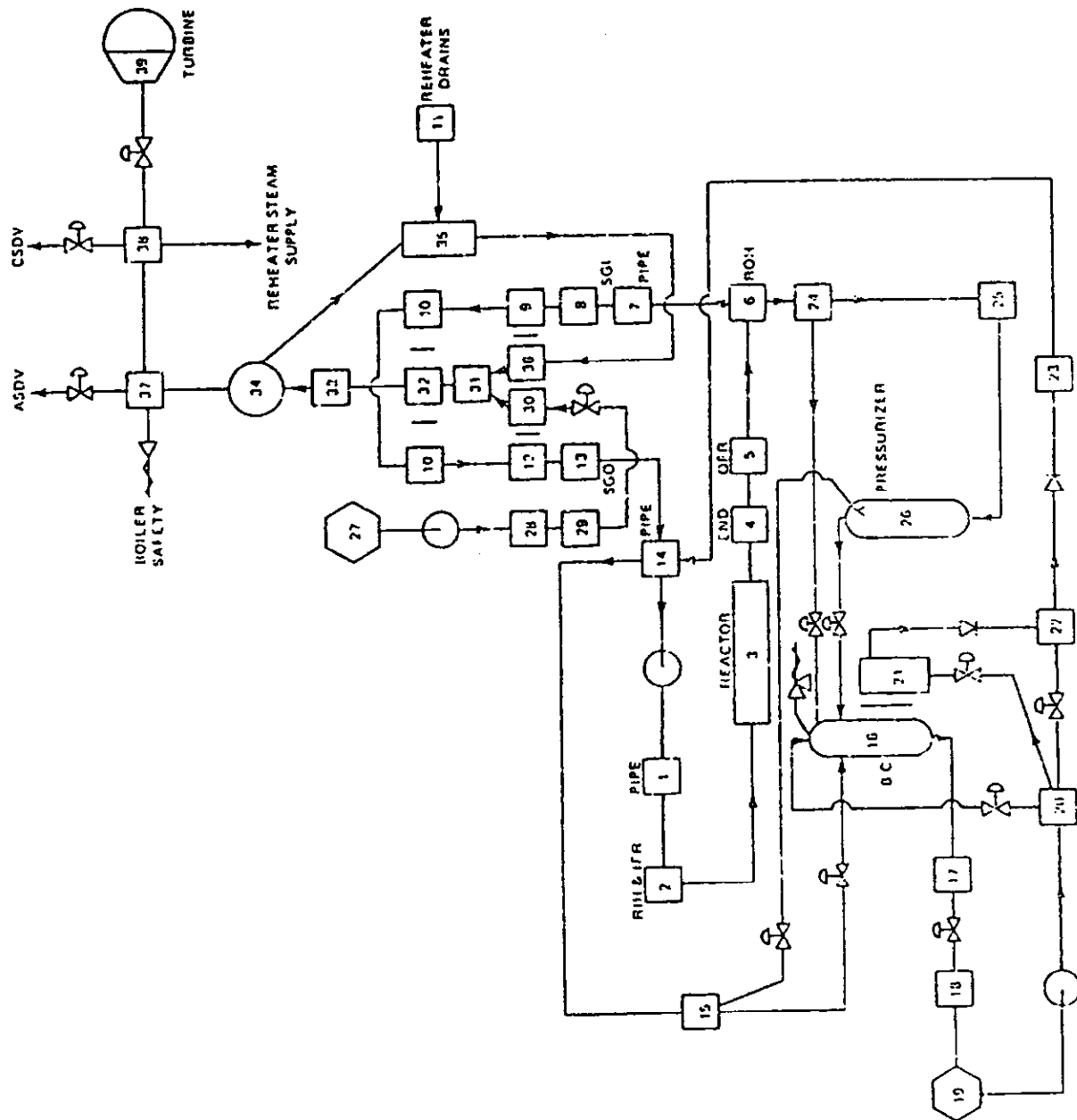

Figure 3.11 Node-link diagram: 1/4 circuit Darlington G.S.

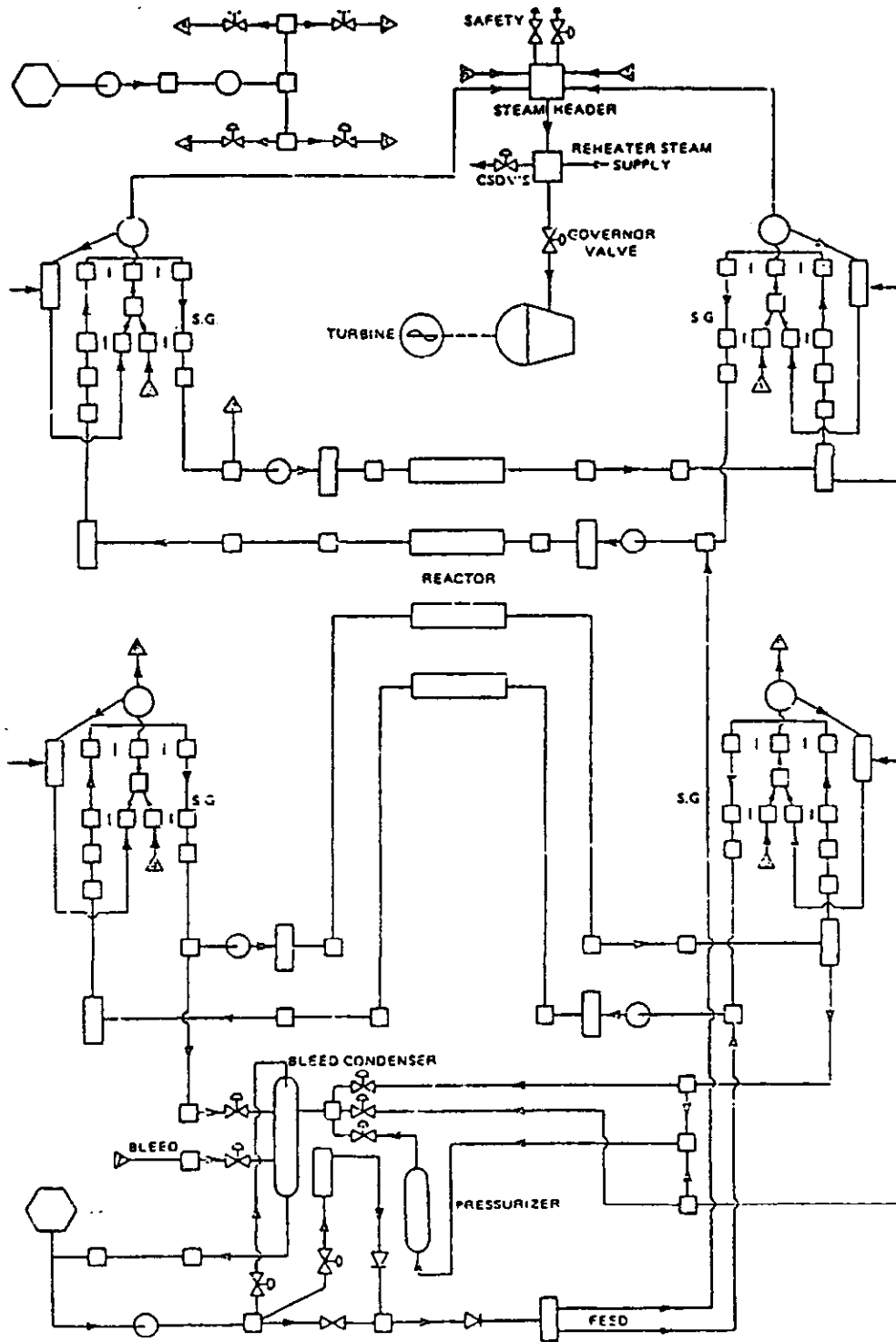

Figure 3.12 Node-link diagram: Full circuit Darlington G.S.

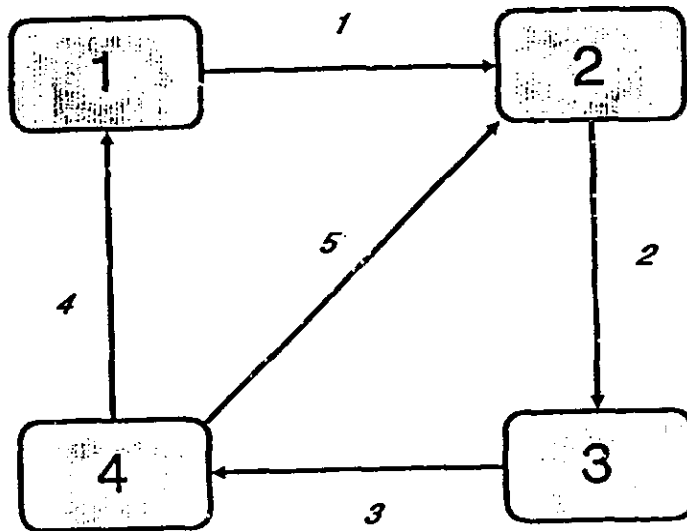

Figure 3.13 4 node - 5 link diagram.