

Reactor, Boiler & Auxiliaries - Course 233

STEAM SUPPLY SYSTEM

I. INTRODUCTION

This section will discuss the turbine steam supply system hardware and its functions. To avoid excessive overlap with the Turbine and Auxiliaries Courses, the hardware description will be short, the emphasis being on the relationship of the steam side components with the HT system rather than with the turbine itself, the latter being the emphasis of the turbine courses. The boiler feedwater system is not discussed here as it is not in the reactor systems USI section.

II. EQUIPMENT DESCRIPTION

(a) Typical Steam Supply System

A typical steam supply system is shown in Figure 1. As stations use different terminologies, these are distinguished in Figure 1 footnotes. The components are described on the following pages followed by a discussion of the boiler steam parameters (flow, temperature, pressure, moisture).

(b) Steam Generator

Figure 2 shows a boiler typical of those used in large generating stations. Hot, pressurized heavy water enters the bottom of the steam generator and passes through the tubes. Because the heavy water is hotter than the light water around the tubes, heat energy is transferred from the heavy water to the light water.

An important constraint exists with regard to the temperature of the feedwater entering the boiler. This temperature should not be too low relative to the average boiler water temperature or physical damage will result to the boiler due to excessive thermal shock. No control loop exists to minimize this temperature difference but temperature alarms exist to warn the operator should this difference become too great.

Figure 1 Typical Steam Supply System

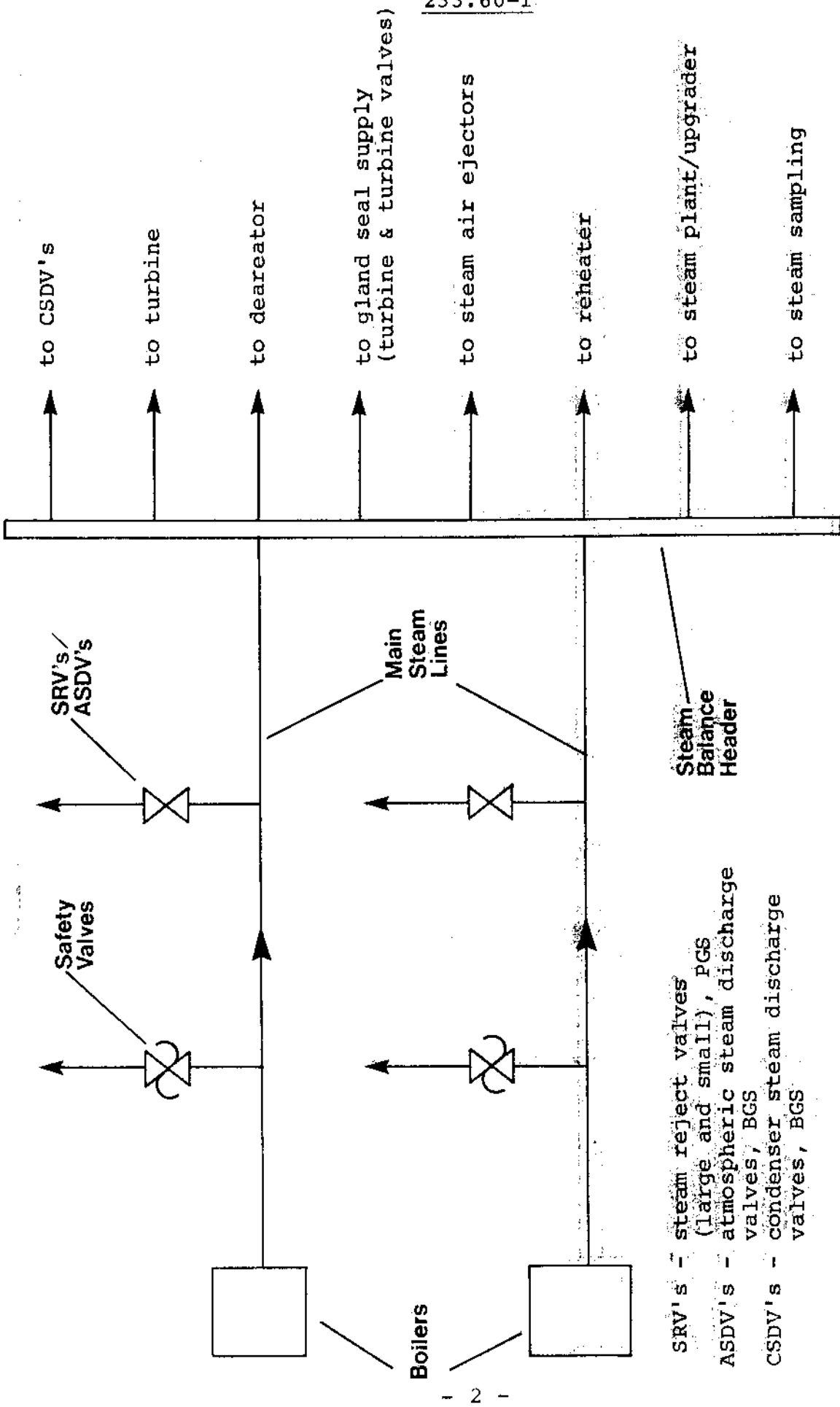

SRV's - steam reject valves (large and small), PGS
 ASDV's - atmospheric steam discharge valves, BGS
 CSDV's - condenser steam discharge valves, BGS

Feedwater enters the boiler near the bottom of the tube bundle. The feedwater as it leaves the last feed-heater, is still much colder (175°C) than the water in the steam generator, and to reduce the possibility of thermal shock to a minimum, the water must be heated up to the saturation temperature (250°C) quickly as it enters the tube bundle. The heating of feedwater to the saturation temperature is accomplished in a preheater on the D₂O outlet side of the boiler. Preheaters are either internal (as shown in Figure 2) or external to the steam generators. In either case, the function of the preheater is to raise the temperature of the incoming feedwater to equal the temperature of the water in the steam generator.

After reaching saturation temperature in the preheater, the water enters the tube bundle area where the latent heat of vaporization is added. Because of the large quantity of steam produced in nuclear steam generators, the boiling is very vigorous, and the steam leaving the top of the tube bundle carries considerable amounts of water with it. In fact, the mixture of steam and water leaving the top of the tube bundle is about 90% water. Any water which is contained in the steam which enters the turbine will rapidly destroy the turbine blading; therefore, the large amounts of water carried with the steam must be removed before the steam leaves the steam generator.

The steam and water mixture is passed through cyclone separators above the tube bundle. Although the cyclone separators are stationary, they are fitted internally with a baffle arrangement which gives the steam a swirling centrifugal motion. The water is denser than the steam, and is thrown to the outside of the separators, where it is drained off. The wet steam which leaves the top of the cyclone separators is much reduced in moisture content but still unacceptable for use in the turbine. This wet steam is then passed through steam scrubbers which reduce the moisture content to ~0.2%. These steam scrubbers consist of overlapping layers of perforated steel plate. The perforations allow the passage of steam, but turn back minute water droplets. Steam quality produced by the boilers should typically be ~99.8%; otherwise turbine blade damage becomes likely.

The large quantities of water which are separated from the steam in the cyclone separators flow to the outside of the steam generator shell and into a downcomer annulus. This downcomer annulus is separated from the tube bundle by a shroud. The water flows down the downcomer annulus and under the bottom of the

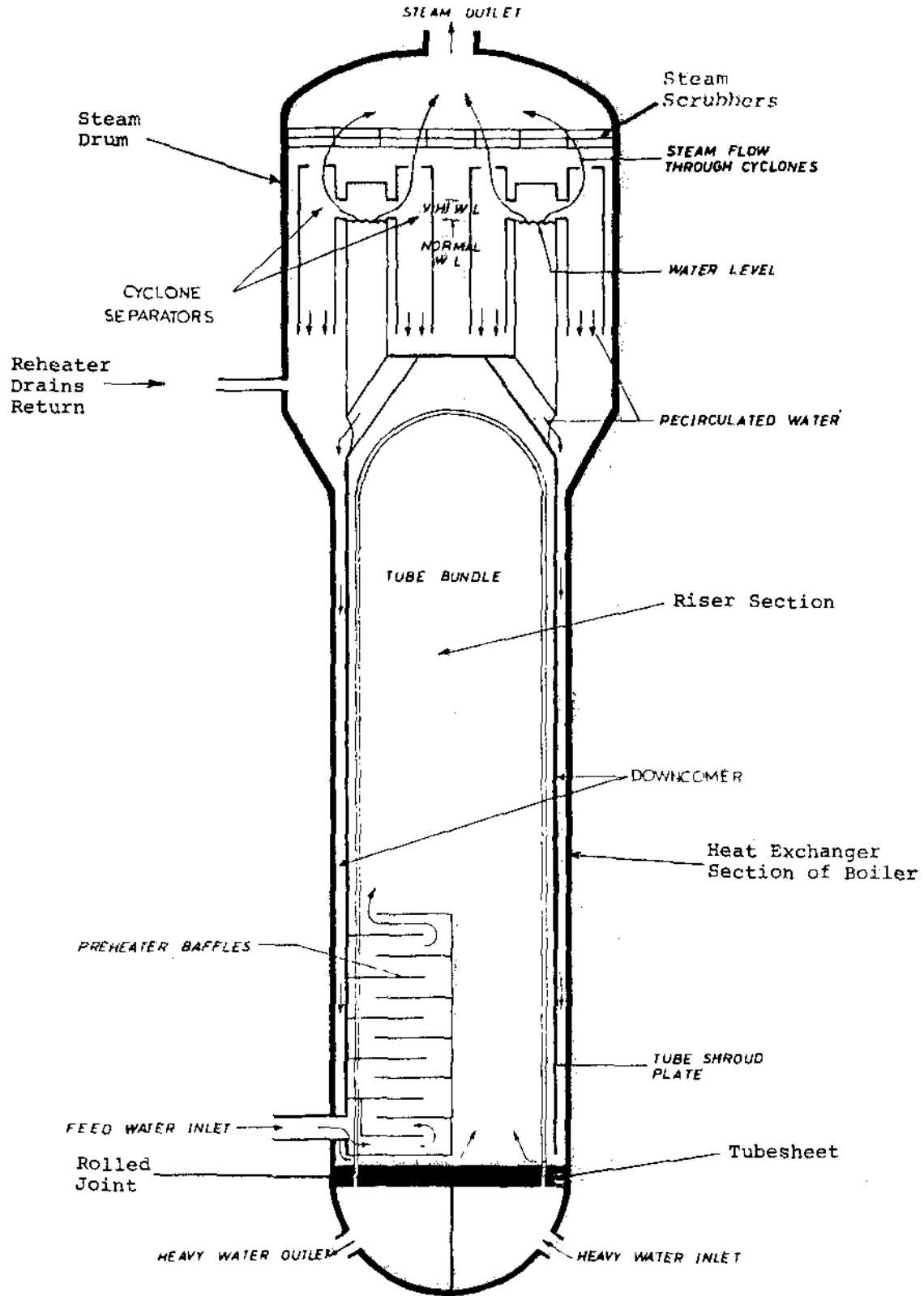

Figure 2: Typical Steam Generator

shroud where it enters the tube bundle area. It then flows up through the tube bundle and more steam is generated. The amount of water entering the tube bundle from the downcomer is typically ten times as much as the amount of feedwater entering into the boiler. (No measurement of this feature is however made in practice.)

The circulation of water through the steam generator is called natural circulation, because the water is moved without the use of pumps. The water and steam around the outside of the boiler tubes move upward because of the addition of heat which decreases the density. The water removed in the cyclone separators is relatively dense and falls down the downcomer and under the shroud to begin the cycle again.

Boiler Connections on Shell Side

Besides the feedwater inlet and the main steam outlet connection on the boiler shell there are a number of other shell side connections that should be mentioned.

The reheater condensate drain line is connected to the steam drum and supplies ~7% of the total boiler feedwater. No control of this drain flow is provided and the inlet temperature of the drains into the drum is around saturation temperature at drum pressure.

Other connections on the boiler are for boiler blowdown. This allows water to be removed from various locations inside the boiler, primarily for improvement in chemical quality of boiler water, although blowdown lines may be used manually to control high boiler levels.

Sample lines are also provided to monitor the boiler water purity, and steam sample lines may be available so that steam quality measurements can be made.

(c) Steam Generator Safety Valves

The steam generator safety valves are installed either on the main steam lines or on the steam generators (Figure 1). The function of the valves is to prevent the steam generators and steam piping from being overpressurized to the extent that the pipework strength could be exceeded. The safeties are required by law (the Boilers and Pressure Vessels Act) and must be capable of relieving full design steam of all the boilers without the steam pressure rising above ~110% of normal working pressure.

Testing once per year is mandatory in the presence⁽ⁱ⁾ of an inspector from the MCCR (Ministry of Consumer and Commercial Relations). If a steam generator safety valve is inoperative, say from being gagged to restrain the disc from lifting at the set (or lift) pressure, then the maximum steam flow from the boilers would have to be reduced so that the remaining safety valves could remove the existing steam flow.

In addition to the standard opening feature of safeties by the lifting of a spring when the set pressure is reached, it is now common to find air-operated actuators on the safeties. These actuators can open the safeties, independent of actual steam pressure, by

- (a) remote manual control from the control room
- (b) automatic action on a low pressure (~ 4 MPa) signal from the main HT system.

These features are installed to be able to obtain (manually or automatically) a crash cool-down feature on a HT LOCA. Modified in this way, the safety valves may sometimes be referred to as instrumented safety relief valves.

The HT system cools down when the safeties open because the boiler pressure falls and hence the average boiler water temperature falls too, according to the saturation line shown in Figure 3. This in turn will reduce HT average temperature (see III (iii) below).

The number of safety valves protecting the boilers is generally between 10 and 20. Lift pressures for these valves are usually staggered so that all valves do not lift at the same time. The purpose of staggered lifts is to ensure that too many safeties are not used to handle the overpressure. This then keeps the mechanical and thermal shock to the steam system to acceptable limits. For a boiler steam system with a maximum operating pressure of 5.03 MPa(a) (eg, Pickering in Figure 4) the lifting range would be typically from 5.38 MPa(a) to 5.54 MPa(a). This range is illustrated in Figure 4 and Figure 5 respectively.

(i) This may be waived at the discretion of the inspector.

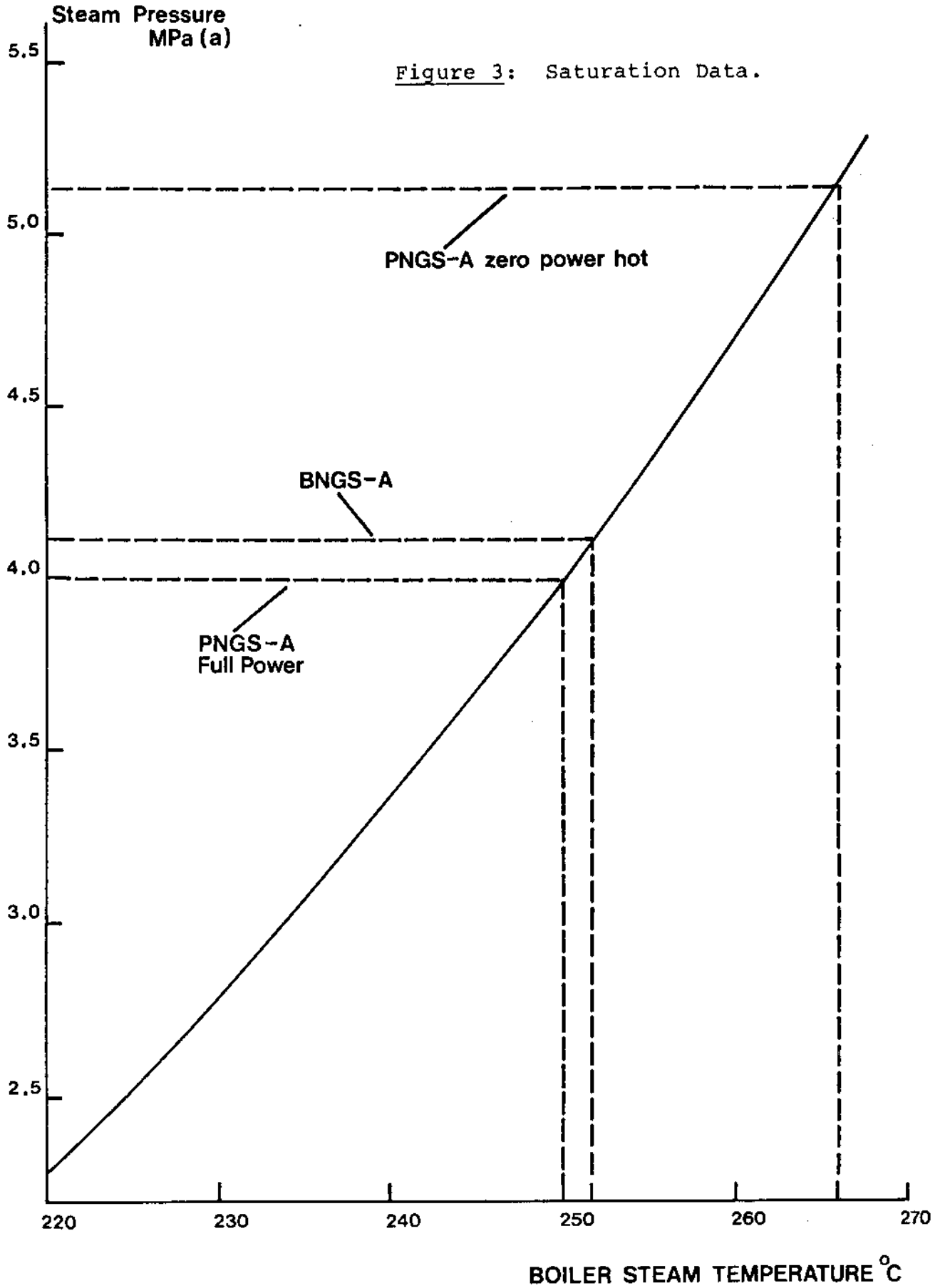

TABLE 1

STEAM SUPPLY SYSTEM VALVE TERMINOLOGY

VALVE NAME	OPERATING FUNCTION	TOTAL STEAM FLOW (%F.P.)
<u>Pickering NGS-A</u>		
small steam reject valves (SRV's)*	reject steam from steam lines to CCW water intake	5%
large steam reject valves (SRV's) ⁺	reject steam from steam lines to atmosphere	100%
<u>Bruce NGS-A</u>		
atmospheric steam discharge valves (ASDV's)*	discharge steam from steam drum to atmosphere	10%
condenser steam discharge valves (CSDV's) ⁺	discharge steam from steam lines to LP condensers	100%(i)

*,⁺ The function of these valves is essentially the same.

(i) Note the capacity actually used is only 75%, as the condenser cannot accept full power steam flow.

(d) Steam Reject Valves

The steam safety valves are required only for boiler overpressure protection and possibly for crash-cool down. These functions do not provide steam pressure control, however, which is necessary as described in section IV below. It would be too complex and less reliable for safeties to provide pressure control in addition to pressure relief. Separate valves are therefore used for pressure control purposes.

The steam pressure control valves are not called by that name and in fact go under different names in different stations. To avoid confusion, Table 1 summarizes the names for Pickering NGS and Bruce NGS and also gives typical percent full power steam relief capacity of the valves. The figures for steam relief capacity help to illustrate their pressure control functions discussed in section IV (i) and (ii) below.

(e) Steam Balance Header

The steam balance header, see Figure 1, or main steam header as it is also called is a large cylindrical steel vessel. It receives the steam from all the boilers and equalizes the steam pressure before the steam goes to the turbine. The balance header also absorbs the expansion forces set up by the thermal expansion of the steam piping as it heats up.

The steam balance header and the steam piping adjacent to it supply steam to the various locations in Table 2. The % of total steam flow of each of these is quoted to illustrate its importance as far as the total steam supply is concerned. The steam supplies of importance as far as a reduction in heat sink capacity is concerned are then in order of importance:

- turbine
- steam plant
- reheaters
- deaerator supply

TABLE 2

STEAM SUPPLY SYSTEM DESTINATIONS

DESTINATION	% OF FULL POWER STEAM
Turbine	~92%
Reheaters	~8%
Turbine Shaft and Turbine Valve Gland Seal	~0.1%
Steam Air Ejectors	hogging ~0.5% holding ~0.05%
Deaerator Supply during Poison Prevent and Startup	~7%
Steam Plant (for BHWP)	up to 111 MW(e) equivalent (Bruce NGS)
Construction Steam	up to ~1%
Upgrading Plant Steam	up to ~1%

III. BOILER STEAM PARAMETERS

A general discussion of boiler steam parameters is given in this section. Of these parameters the ones which are controlled, namely boiler pressure and steam flow are discussed from their control aspects in sections IV and V below.

(i) Flow

Boiler steam at power will be produced at the rate of ~5,400 kg/hr (1.5 kg/sec) for each 1 MW(e) of electrical output. This figure is approximately the same for all plants.

Steam flow is one of the parameters used for the boiler water level control, see V below.

(ii) Temperature

Steam temperature at the steam drum outlet is close to the HT temperature at the boiler outlet. The actual temperature is the saturation temperature at the boiler steam drum pressure.

Note that steam temperature, while indicated in the control room is not used for any control function, but steam pressure is.

(iii) Pressure

Steam pressure at the boiler outlet is the saturated steam pressure at the steam temperature. Therefore, knowledge of either pressure or temperature is adequate to determine from steam tables, the other parameter of the two, providing the system is still boiling.

Pressure is measured at the steam lines close to the boilers (to reduce pressure fluctuations caused by turbine governor valve movements), and the measurements are used for boiler pressure control in a computer program called BPC, mentioned further below.

(iv) Moisture

In order to prevent excessive erosion and maintain acceptable turbine efficiency, the maximum moisture content of the steam in a turbine must be limited to about 10 - 12% and the average turbine stage moisture content to approximately 5%.

IV. BOILER PRESSURE CONTROL

Boiler steam pressure control performs the following functions:

- (i) Matching reactor and turbine power.
- (ii) Rapid transfer of heat sink from the turbine in the event of a turbine trip or a load rejection.

In order to understand why steam pressure is used as the control parameter, one must first understand how thermal power is transferred across the tubes of the boiler. This power may be expressed by the relation.

$$\dot{Q} = U.A.T \quad (i)$$

where \dot{Q} = the thermal power conducted from the heat transport system to the water in the steam generator. (kJ/sec = kW(th))

U = the overall heat transfer coefficient of tubes. (kJ/m²/°C/sec)

A = the total tube area. (m²)

T = the difference between the average heat transport system temperature in the tubes and the temperature of the water in the steam generator riser. (°C)

Since A and U are virtually independent of reactor power, \dot{Q} is directly proportional to T.

The temperature difference T can be written as:

$$T = T_{\text{average HTS}} - T_{\text{steam generator}}$$

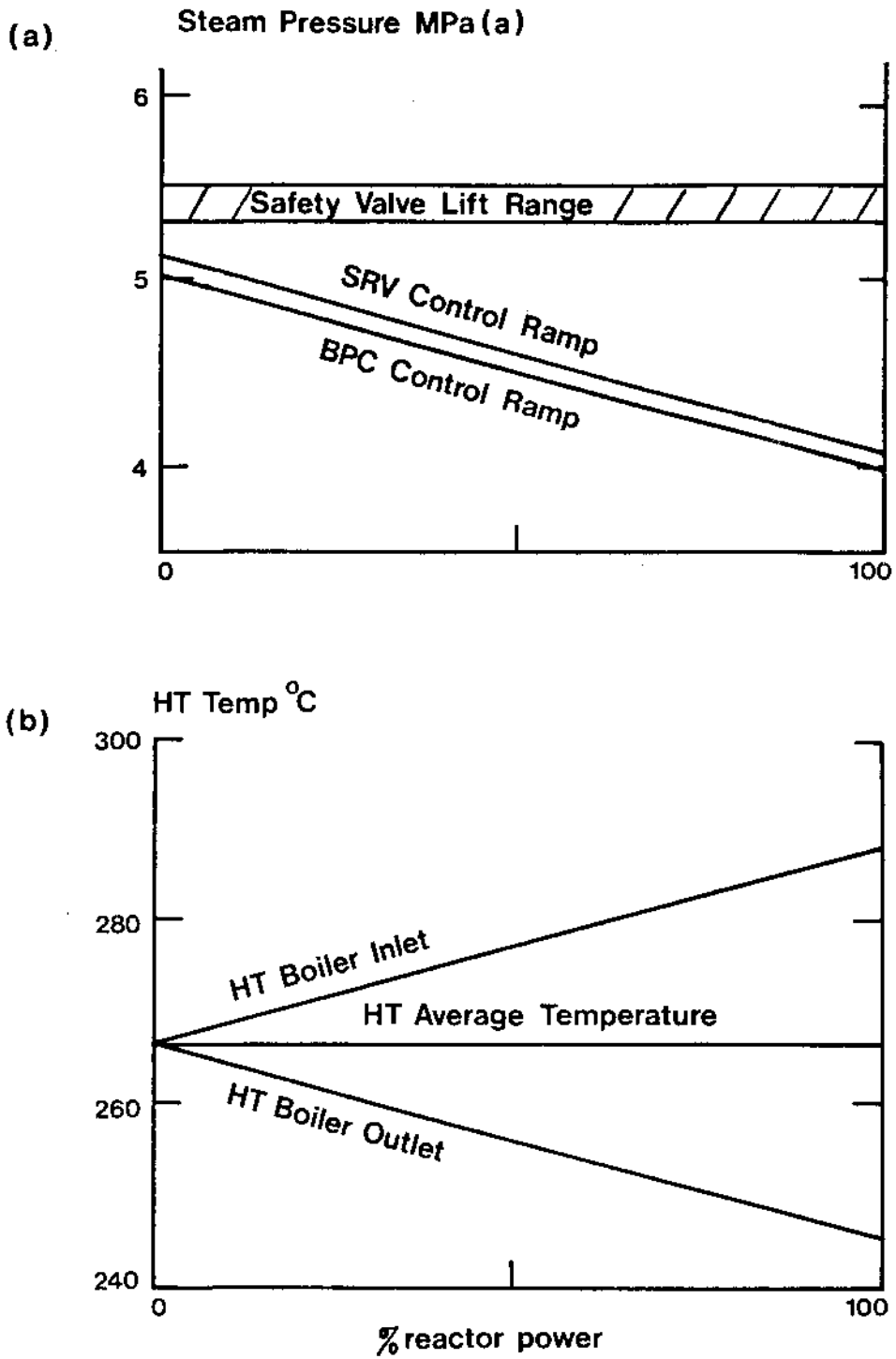

Figure 4: PNGS Boiler Pressure and HT Temperature Relationships

Hence for ΔT to increase, the average heat transport system temperature must go up, or the steam generator temperature must go down, or both must occur simultaneously. In some plants (Pickering NGS, for example) the HT system average temperature is held approximately constant as reactor power changes, in order to limit coolant swell (expansion) and shrinkage (contraction). This is particularly desirable if a surge tank is not available to smooth out rapid pressure changes. Figure 4(b) illustrates the Pickering NGS HT temperature/power relationship. In this case, as power level increases, the steam generator temperature must decrease. If steam generator temperature decreases, then, since the steam generator is saturated, steam generator pressure must decrease. Figure 4(a) shows this for Pickering. The pressure/power line shown here is sometimes called the boiler pressure control ramp.

In other plants (Bruce, for example), there is a pressurizer to accommodate rapid volume changes in the HT coolant. Here the steam generator temperature is held constant, and the average HT temperature increases as power increases, see Figure 5(a). This means the steam generator pressure remains constant, as shown in Figure 5(b).

It may not seem obvious why steam pressure, rather than temperature is used to control the amount of heat transferred from the HT system to the steam system. The reason is one of thermal time delay (a few seconds) in being able to measure a temperature change of the steam in the steam drum. Pressure measurements are of faster response and hence steam pressure control gives more rapid control response than steam temperature control.

The physical methods of providing the boiler pressure control functions are now discussed.

(i) At Power Boiler Pressure Control

When the turbine is being used as the primary heat sink at full power and the steam pressure rises more than 100 kPa(a) above the BPC control ramp setpoint then the SRV's (or ASDV's and CSDV's) are used as a secondary heat sink. These valves will open automatically to discharge steam until the steam pressure returns to the setpoint value of the BPC ramp. The 100 kPa(a) offset is shown as the SRV control ramp in Figure 4(a).

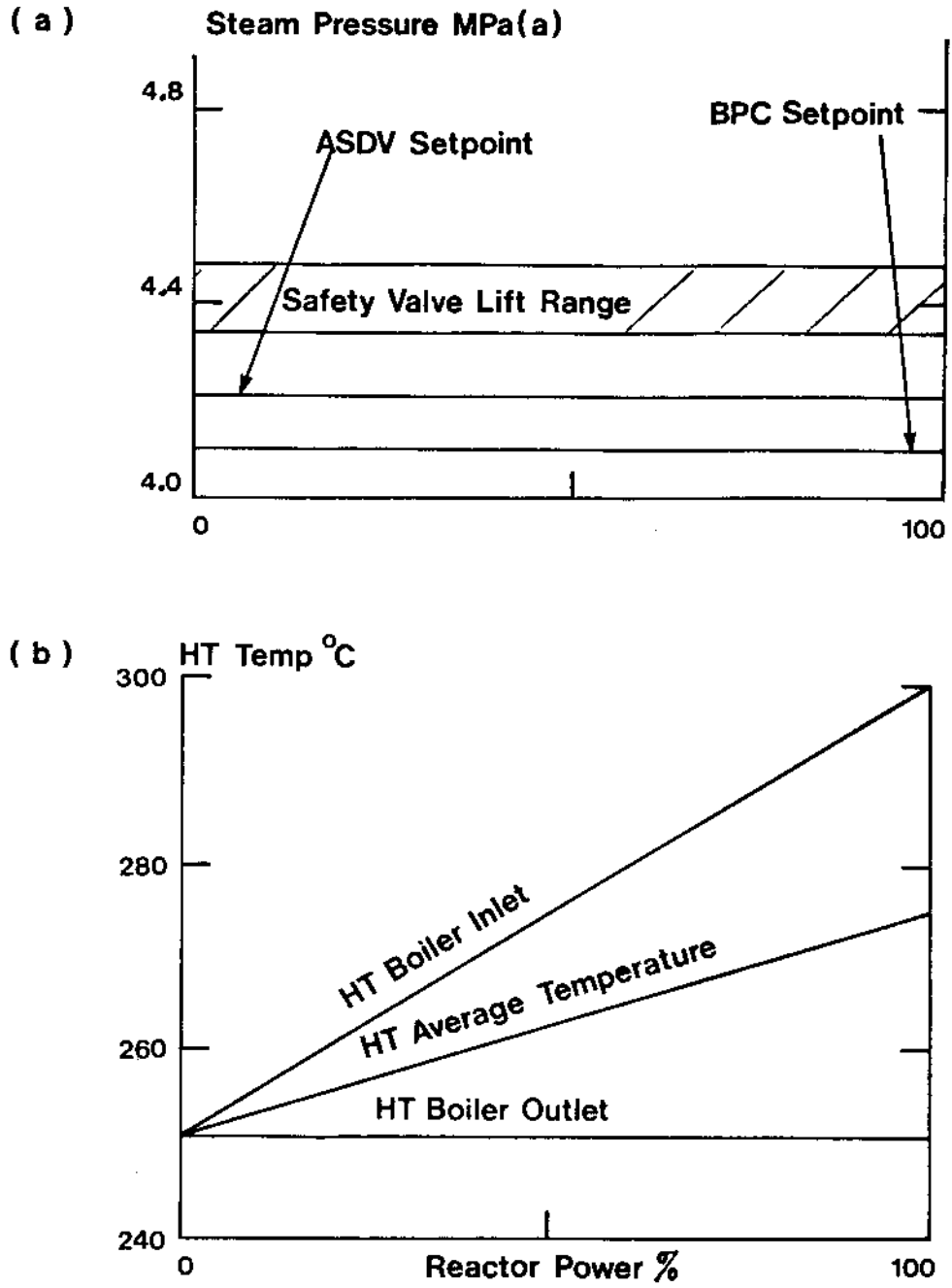

Figure 5: BNGS Boiler Pressure and HT Temperature Relationships

When the steam discharge valves open, the atmosphere is in effect being used as a heat sink, in addition to the turbine. The higher boiler pressure causing the valves to open means there is a reduced ΔT between coolant and boiler water hence an additional heat sink to the turbine is needed.

In most cases the small SRV's (or ASDV's) are adequate for pressure control. They are designed to release only a few percent of full power steam flow (see Table 1). However, the larger SRV's (or CSDV's) would open if larger pressure rises occurred, see (ii) below.

If the steam pressure decreases by more than an offset value (~ 100 kPa(a)) below the boiler steam pressure setpoint the boiler pressure control program initiates a turbine runback by closing the governor valves until boiler pressure returns to its setpoint. This effectively reduces the turbine heat sink until reactor power is again matched by turbine power.

(ii) Rapid Transfer of Heat Sink From Turbine to SRV's on a Turbine Trip or Load Rejection

In the event of a turbine trip, fast turbine runback or a loss of electrical load, the SRV's (or CSDV's) open to release the steam flow previously taken by the turbine. The effect is the same as (i) above but much greater because more steam is released. The valves are designed to release 100% of full power steam flow, see Table 2. (Note that at Bruce NGS the condenser limits the release to 75% via the CSDV's.) Failure of the valves to open would result in an increase in steam pressure, safety valves lifting, a rise in HT average temperature and possibly a reactor trip on high HT system pressure.

If the turbine outage causing the above transient is likely to last less than ~ 40 hours, then it is advantageous to keep the reactor operating to prevent it from poisoning out.

At Pickering NGS the SRV's act as the primary heat sink, discharging steam to atmosphere. Reactor power is reduced to $\sim 70\%$ to conserve feedwater; but cannot be reduced further below $\sim 70\%$ without poisoning out. In fact the feedwater supply at Pickering will last $\sim 5 - 6$ hours at $\sim 70\%$ power so that this time actually sets the period for which poison prevent operation can be considered.

At Bruce, the only concern is to prevent reactor poison out as the CSDV's discharge steam to the condenser, thus recirculating feedwater in a closed loop. One might therefore plan to operate a Bruce unit for up to 40 hours, the poison shutdown time, as there is no feedwater supply time limit as at Pickering.

V. BOILER LEVEL CONTROL

The reasons boiler water level has to be controlled are that:

- (i) too high a boiler level may result in water carryover to the turbine with possible blade damage, and
- (ii) too low a boiler level will result in reducing the available heat sink for the reactor power (by uncovering the boiler tubes).

The three variables used for boiler level control are:

- boiler level
- steam flow (i)
- feedwater flow (i)

The detailed control scheme will not be discussed here but we will look at how and why steam drum (boiler) level is controlled with respect to steam flow and hence reactor power. The boiler level control system is a self contained control system (analogue in older stations, digital in newer stations) which monitors steam drum level, steam flow and feedwater flow. Separate sets of steam drum level sensors are used to monitor each boiler level, one set for level control and one set for protective action on high and low boiler levels. Protective action includes a reduction in reactor power on very low boiler level and a governor steam valve trip (or emergency stop valve trip) on very high boiler level.

Figure 6 shows how the actual steam drum level (steam/water mixture) varies with steam power (hence reactor power). The "ramp", of increasing boiler level with steam power, is created by the boiler level control system in order to protect the turbine and the heat transport system (boiler tubes) from transient shrink and swell of the steam/water mixture within the boiler.

-
- (i) At low power (typically <15% FP) single variable (element) control is used at Bruce NGS, steam and feedwater flow measurements being unreliable at low loads.

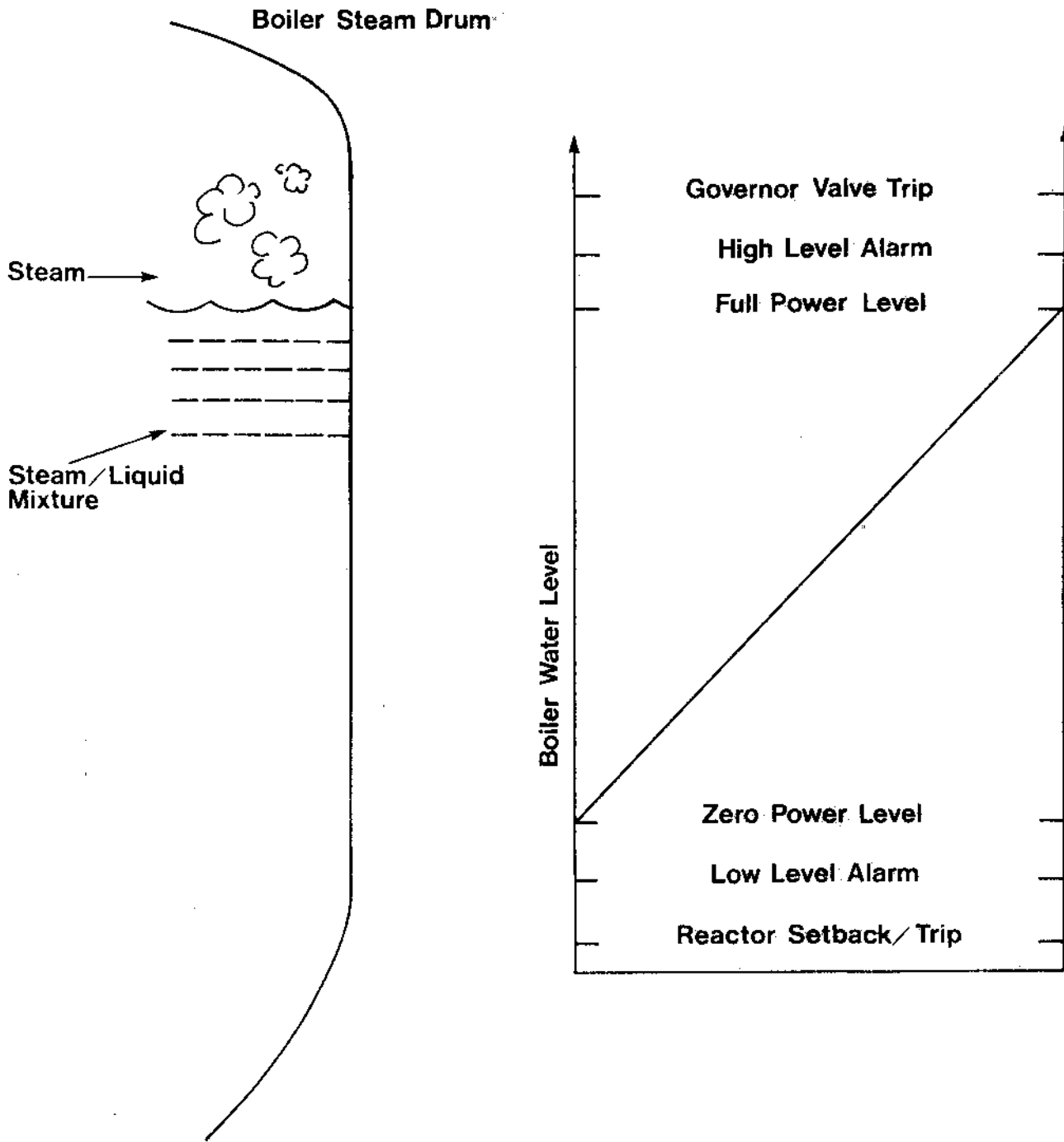

Figure 6: Boiler Steam Drum Water Level Setpoint

Increase Will Increase
Level

Increase Will Decrease
Level

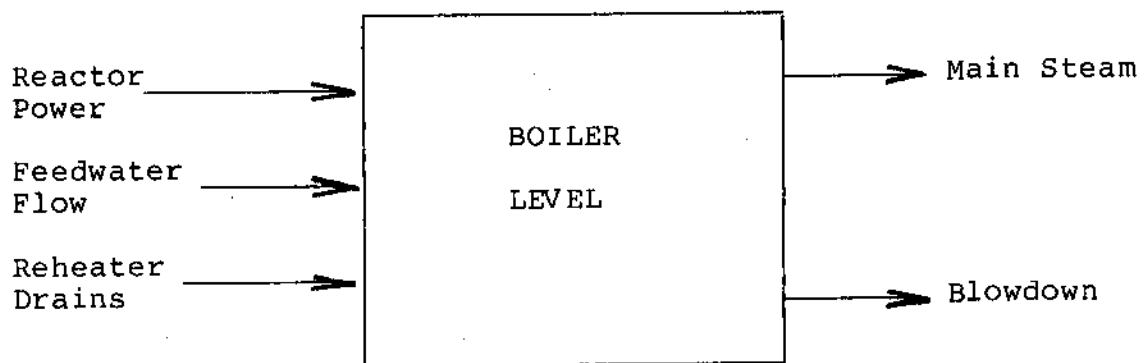

Figure 7: Factors Which Influence Boiler Level

Swell in the boiler occurs during an increase in steaming rate, due to an increased volume of entrained steam. If there is an increase in steam flow from the boiler the boiler pressure will drop causing a rapid increase in the steaming rate. This sudden increase in entrained steam will cause a rise in the steam/water level within the steam drum. This swell is a transient effect lasting a matter of seconds.

Shrink in the boiler occurs during a decrease in steaming rate, due to the decreased volume of entrained steam. If there is a decrease in steam flow from the boiler the pressure will increase causing a rapid decrease in the steaming rate. This sudden decrease will cause a drop in the steam/water level within the steam drum. The shrink is also a transient effect lasting a matter of seconds.

Notice that while the terms "swell" and "shrink" are the same as those used in reference to the primary heat transport system, the effect here is entirely different. (Remember swell and shrink in the PHT system refer to expansion and contraction of liquid D₂O due to temperature changes.)

To provide maximum protection of the system against swell and shrink in the boiler, a programmed boiler level (determined by steam power) is used. This programmed level insures that the level is highest when the risk of shrink is the greatest (at maximum steam power) and also insures that the level is lowest when the risk of swell is greatest (at minimum steam power).

The high and low boiler level alarms have setpoints slightly above and below the programmed boiler level ramp, respectively.

All plants provide for manual adjustment of boiler level in case of a feedwater control valve failure. Boiler blowdown lines may be used for this purpose once the defective feedwater valve has been isolated using other valves on the defective line. Opening a blowdown line tends to decrease boiler level. (The capacity of the blowdown lines, however, is much less than the normal feedwater or steam flow.)

Boiler isolating valves, in each boiler feedwater inlet line may also be adjustable (remote manual) - throttling open tends to raise boiler level, throttling closed tends to lower boiler level. This trimming of boiler water level is done, especially at Pickering NGS-A, during fuelling operations and during adjuster rod movement to adjust individual boiler steaming rates and hence boiler levels to the same values. Inefficient mixing of HT D₂O in

the reactor outlet header(s) can result in different steaming rates between boilers served by the same HT header. The boiler feedwater valve serving these boilers will then not be able to match feedwater flow to steam flow for each boiler in the group when channel powers change in core. Use of the individual boiler isolating valves for trimming of boiler levels is then done despite the fact the isolating valves are not designed for control.

Summarizing all the factors which can influence boiler level, Figure 7 illustrates those which tend to increase or decrease boiler level.

ASSIGNMENT

1. If your plant is not Pickering NGS nor Bruce NGS, what is your stations equivalent of the valves given in Table 1.
2. On Figures 4 and 5 plot the average boiler steam temperature between 0% and 100% power using data from Figure 3. Indicate how T from equation (i) can be calculated from the graphs.

D.J. Winfield
V. D'Angelo