



Introduction to Reactor Physics

B. Rouben

Manager, Reactor Core Physics

2002 September

Canada 



AECL
Atomic Energy
of Canada Limited

EACL
Énergie atomique
du Canada limitée



Introduction

- This is a **descriptive** course on the physics of CANDU reactors.
- The objective is to familiarize you with the basic **concepts and ideas, definitions and quantities** which are important in the understanding of reactor physics.
- The discussion will be at a basic level, as this is an introduction to the subject. There will be very little emphasis placed on complex equations or difficult mathematics.
- The desired outcome of this course is that you will be able in the future to understand and follow reactor-physics discussions in meetings, reports or presentations.



Introduction

- **Nuclear energy is energy from the nuclei of atoms. It is quite natural - it occurs and has occurred in nature in various forms since the beginning of the universe.**
- **Let us start with the law of conservation of energy.**



Law of Conservation of Energy

It all starts with

- Equivalence of mass and energy (Einstein):

$$E = mc^2$$

- Any change in mass in a reaction is accompanied by release or intake of energy.
- This was a revolutionary idea because change in mass had never been seen in chemical reactions (too small to measure).



Chemical Energy vs. Nuclear Energy

- **Chemical energy comes from changes in atoms and molecules - actually their electron clouds. Chemical energy is the true atomic energy!**
- **Nuclear energy comes from changes in the nuclei of atoms. Energies involved in nuclear reactions are much larger than those in chemical reactions - typically hundreds of thousands, or millions, of times greater.**
- **Whereas energies released in chemical reactions are measured in electron volts ($1 \text{ eV} = 1.6 * 10^{-19} \text{ J}$), those released in nuclear reactions are measured in millions of eV (MeV).**



Nuclides

- A nuclide is a nucleus with specific a number of protons and of neutrons (e.g., ^{16}O has 8 protons and 8 neutrons).
- Number of protons (Z) = atomic number (specific element).
- Different nuclides of element may exist, with same Z but different numbers of neutrons (N): isotopes.
- Protons and neutrons have almost the same mass, and $A = Z+N$ is the atomic mass.
- e.g. uranium (U) has 92 protons ($Z = 92$).
- Natural uranium: 99.3% ^{238}U (146 neutrons) and 0.7% ^{235}U (143 neutrons).



^{235}U

92 Protons ●
143 Neutrons ●

^{238}U

92 Protons ●
146 Neutrons ●

Two Uranium Isotopes



The Source of Energy: Fission

Neutron-induced fission of a large nucleus, e.g. ^{235}U :

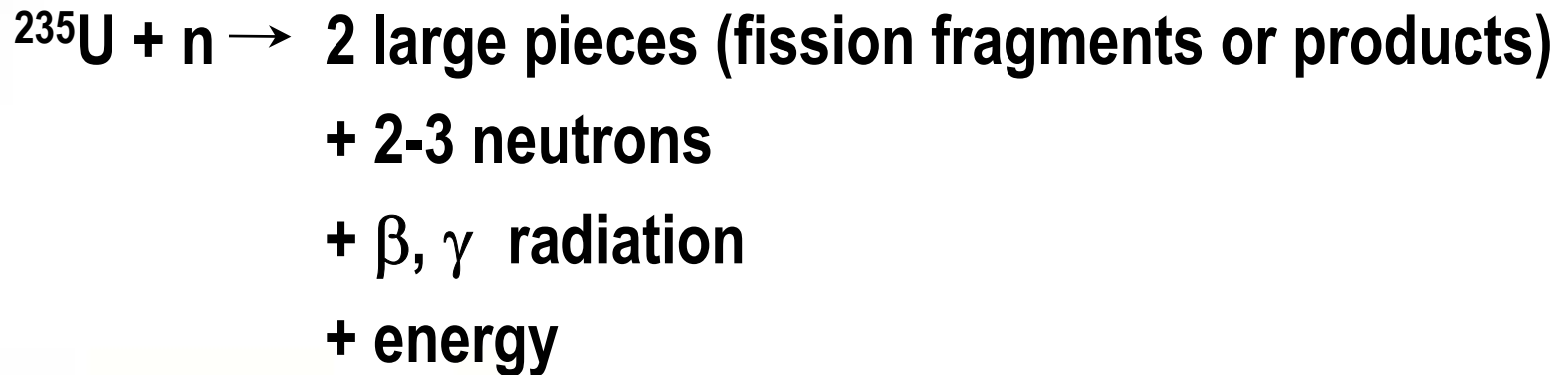

FISSION

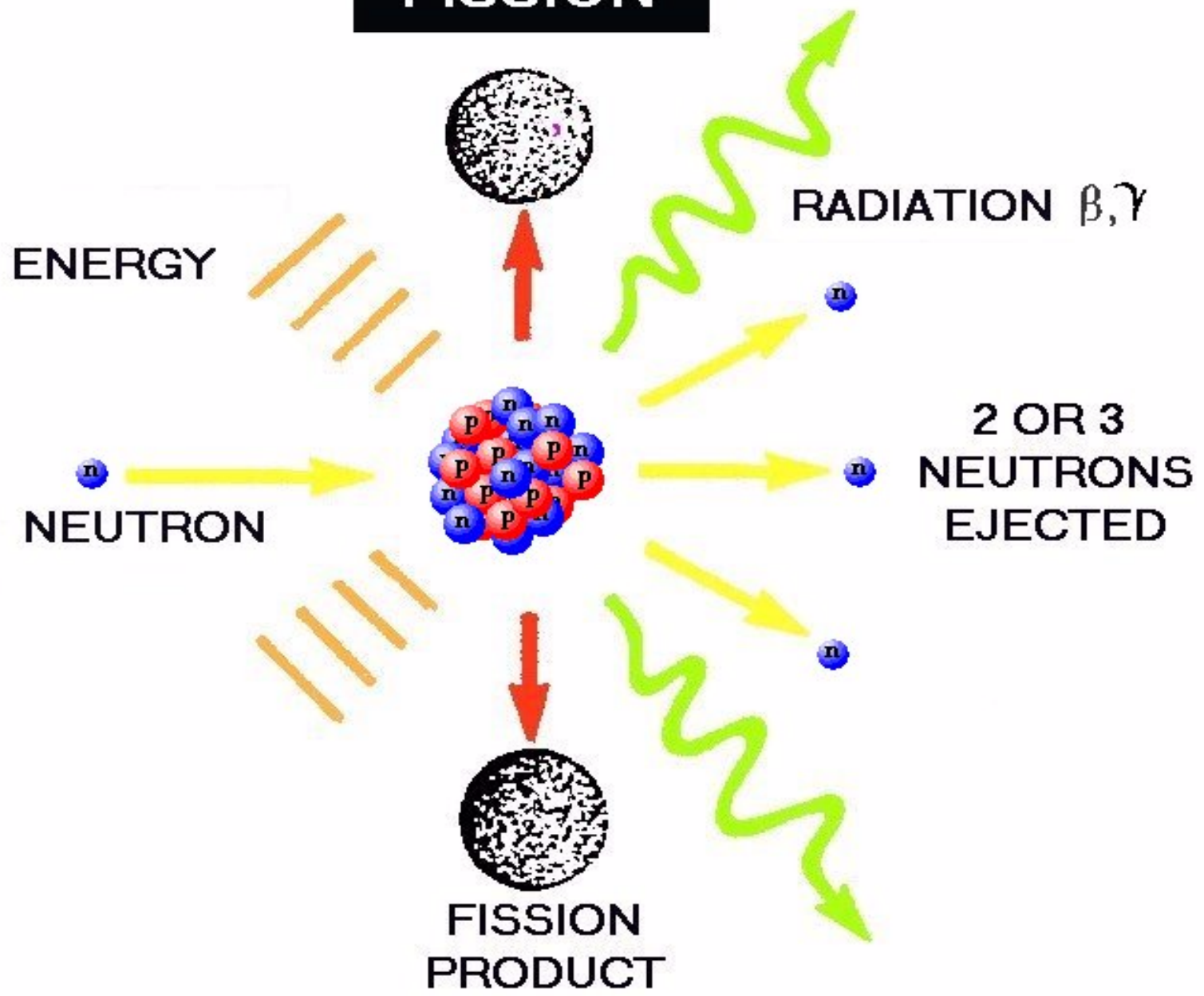



Application of Fission

Fission reaction:

- **energy is released, and**
- **process has potential of being self-perpetuating, since neutrons which emerge from fission can induce more fissions: **chain reaction** - multiplying medium.**
- **process is open to control by controlling the number of fissions, or, in fact, the number of neutrons.**

This is the operating principle of fission reactors.



Fissionable and Fissile Nuclides

- Only a few nuclides can fission.
- A nuclide which can be induced to fission by an incoming neutron of **any** energy is called **fissile**. Only one naturally occurring fissile nuclide: ^{235}U .
- Other fissile nuclides: ^{233}U , some isotopes of plutonium, ^{239}Pu and ^{241}Pu ; none of these occurs in nature to any appreciable extent.
- **Fissionable** nuclides: can be induced to fission by neutrons only of energy higher than a certain threshold. e.g. ^{238}U and ^{240}Pu .

[Note the fissile nuclides have **odd** A. This is because of the greater binding energy for **pairs** of nucleons.]



Energy from Fission

Energy released per fission ~ 200 MeV [$\sim 3.2 \cdot 10^{-11}$ J].

This is **hundreds of thousands, or millions, of times greater than energy produced by combustion**, but still only $\sim 0.09\%$ of mass energy of uranium nucleus!

Energy appears mostly (85%) as kinetic energy of fission fragments, and in small part (15%) as kinetic energy of other particles.

- The energy is quickly reduced to heat,
- The heat is used to make steam by boiling water,
- The steams turns a turbine and generates electricity.



Schematic of a CANDU Nuclear Power Plant

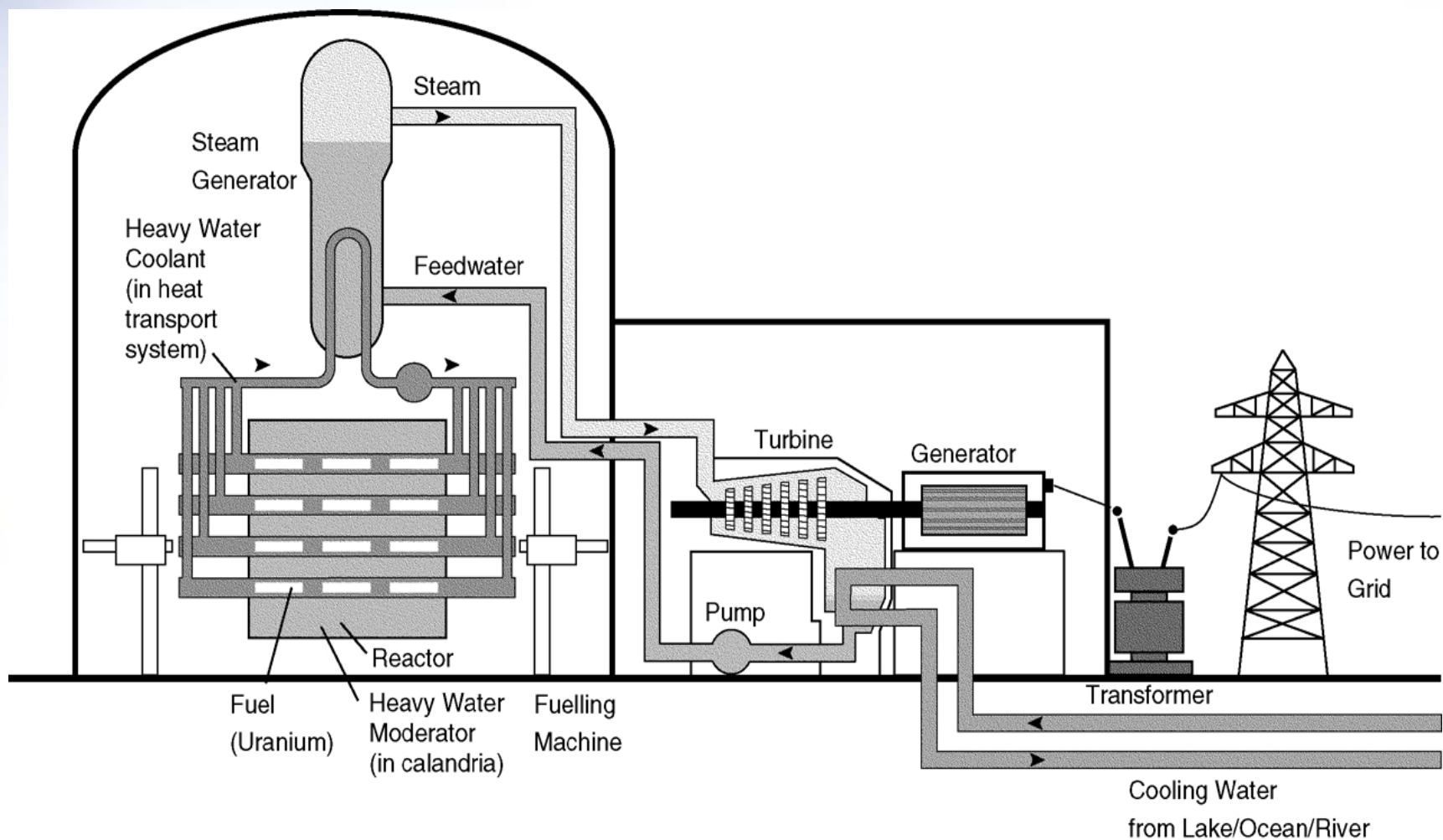



Products of Fission

- The fission products (fission fragments) are nuclides of roughly half the mass of uranium.
- Not always the same in every fission. There are a great number of different fission products, each produced in a certain percentage of the fissions.
- Most fission-product nuclides are “neutron rich”; they decay typically by β - or γ -disintegration, and are therefore radioactive, with various half-lives.
- To prevent the release of radioactivity, therefore, the used fuel is safely stored and contained.



Decay Heat

- Many fission products are still decaying long after the originating fission reaction.
- Energy (heat) from this nuclear decay is actually produced in the reactor for many hours, days, even months after the chain reaction is stopped. This decay heat is not negligible.
- When the reactor is in steady operation, decay heat represents about 7% of the total heat generated.
- Even after reactor shutdown, decay heat must be dissipated safely, otherwise the fuel and reactor core can seriously overheat. Next Figure shows the variation of decay heat with time.

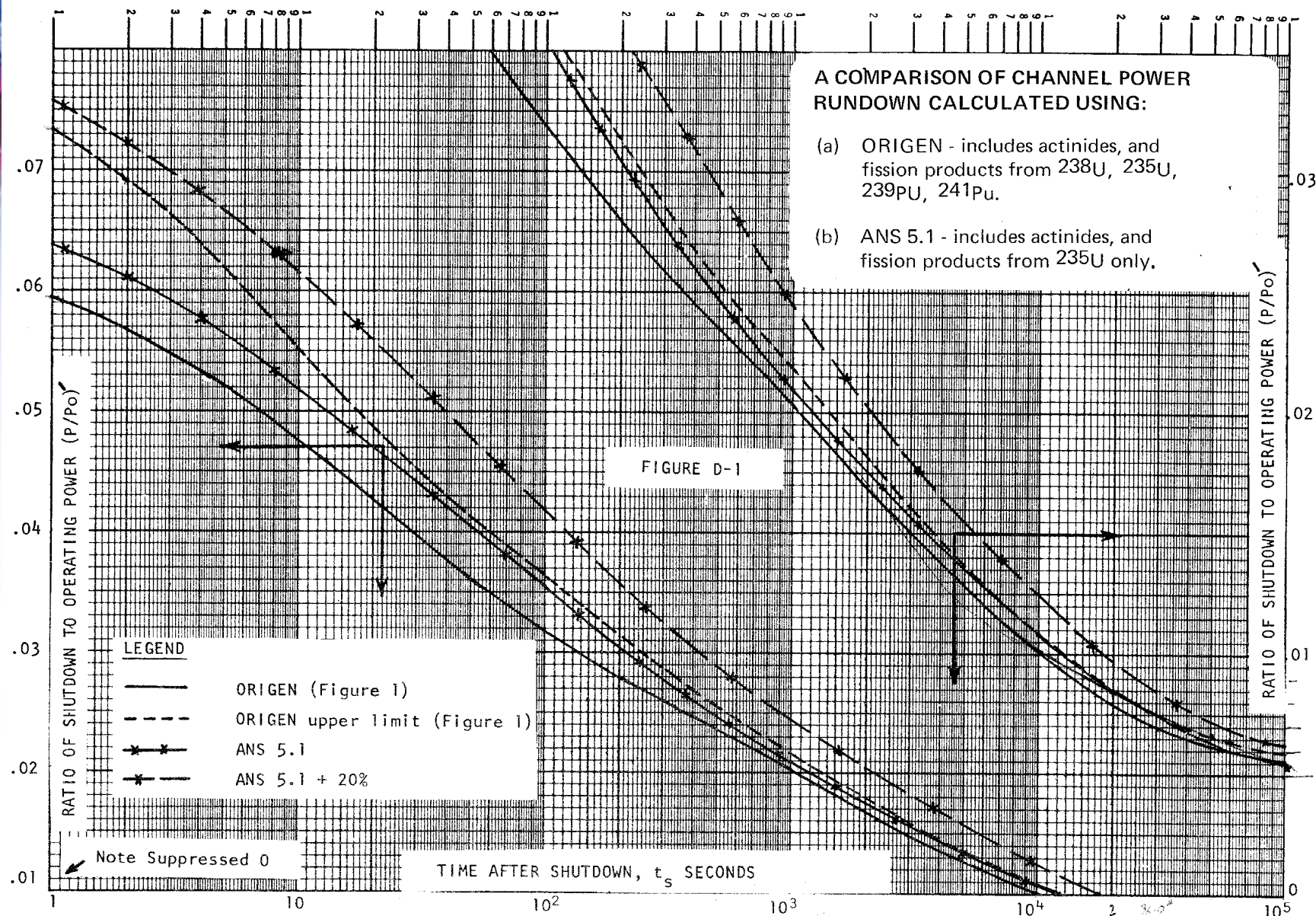

Decay-Heat Curves vs. Time



Transuranics

Produced from absorption of neutrons by ^{238}U : plutonium, americium, curium, etc.

e.g., production of ^{239}Pu :



^{238}U is said to be **fertile** because it yields **fissile** ^{239}Pu .

Half the energy produced in CANDU is from plutonium created “in situ”!

Actinides tend to have long half-lives, e.g. for ^{239}Pu 24,000 y.



Fast and Thermal Neutrons

- **Distribution of fission-neutron energies has maximum at ~1 MeV (see next Figure). This kinetic energy corresponds to a neutron speed of ~13,800 km/s!**

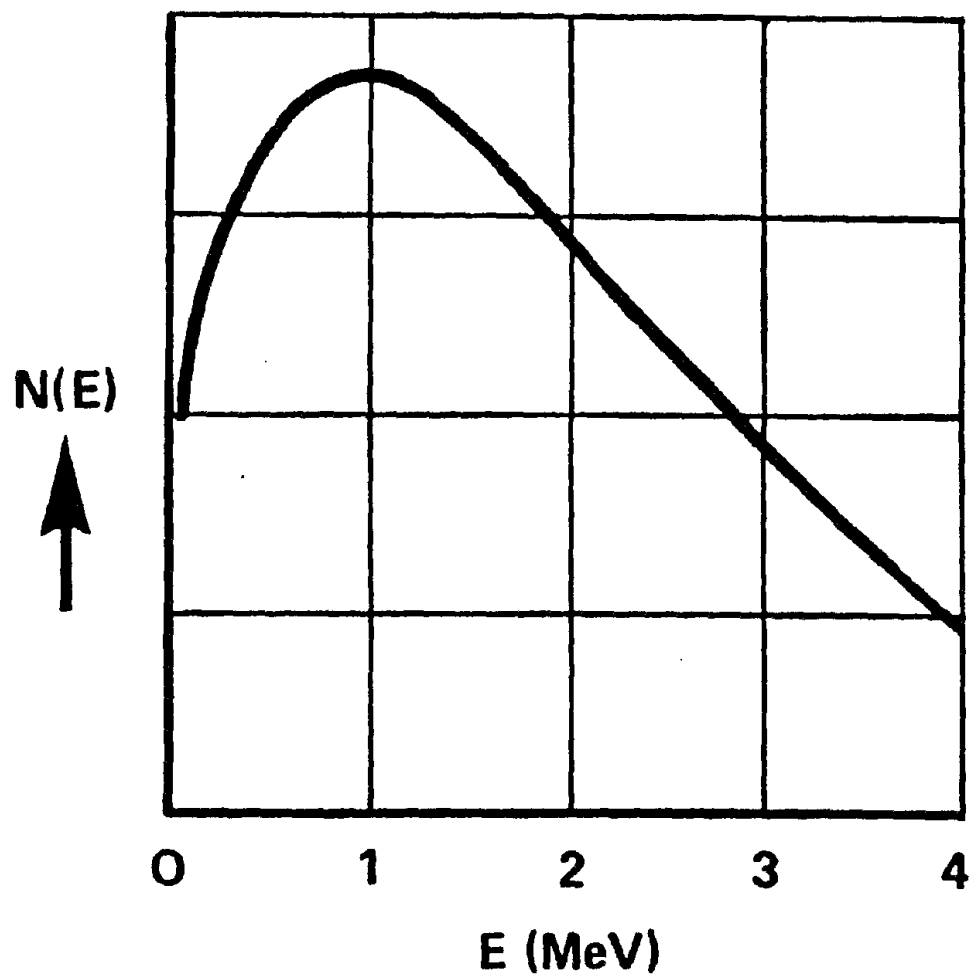

Energy Distribution of Fission Neutrons



Fast and Thermal Neutrons

- The probability of a neutron inducing fission in ^{235}U is very much greater for very slow neutrons than for fast neutrons (see next Figure).
- So we want to slow the neutrons down as much as possible.
- Maximum slowing down is to “thermal” energies. For a temperature of 20°C , thermal energies are of order of 0.025 eV (n speed = 2.2 km/s).
- [As neutrons slow down from energy $\sim 1\text{ MeV}$ to thermal energies, they may be absorbed in fuel. In “resonance” energy range, $\sim 1\text{ eV} - 0.1\text{ MeV}$, probability of non-productive absorption in fuel is great. More about this later.]



TYPICAL BEHAVIOUR OF NEUTRON CAPTURE OR FISSION CROSS SECTION WITH ENERGY

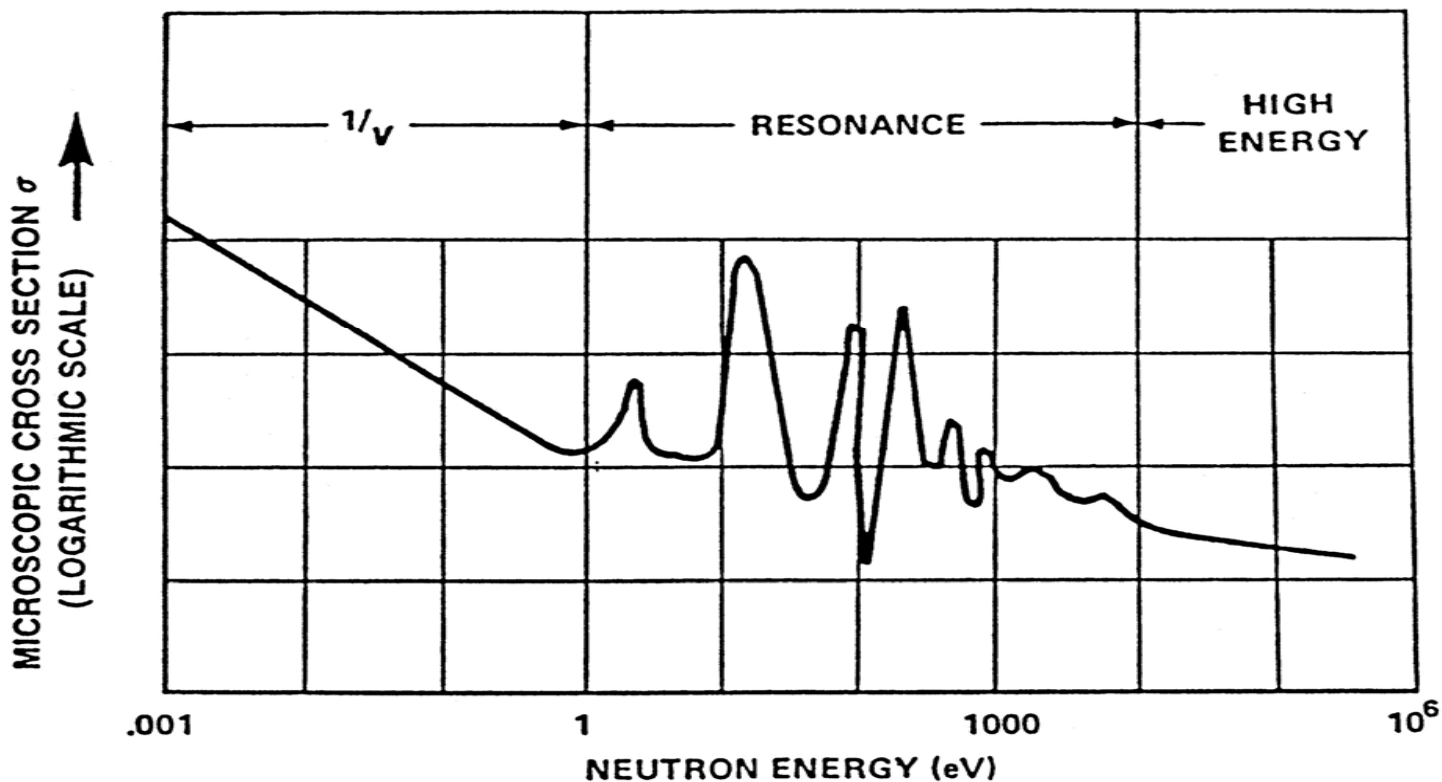

Schematic View of a Typical Cross Section, Showing Resonances



Moderators

- Maximum slowing down is to “thermal” energies. For a temperature of 20° C, thermal energies are of order of 0.025 eV (n speed = 2.2 km/s).
- Most efficient moderator has atoms of mass close to neutron mass: hydrogen (H) - e.g., H in water (H₂O)
- But H captures neutrons easily, “robs” them from circulation and does not allow self-sustaining chain reaction (except in uranium “enriched” in ²³⁵U)
- Deuterium (“heavy H” - 1p, 1n) has mass 2, next closest in mass to neutron; also, is a very poor neutron absorber - big advantage: **Heavy water (D₂O) is an excellent moderator!**



Fuel Requirements

Energy in fission immense:

**1 kg (U) in CANDU = ~ 180 MW.h(th)
 = 60 MW.h(e).**

Typical 4-person household's electricity use

= 1,000 kW.h/mo = 12 MW.h/year, then

a mere 200 g (< 0.5 lb) (U) - 6 to 8 pellets -serves 1 household for an entire year. [Cf: If from fossil, ~ 30,000 times as large, ~ 6,000 kg coal.]

Cost of nuclear electricity insensitive to fluctuations in price of U.



Reactor Multiplication Constant

- **Several processes compete for neutrons in a nuclear reactor:**
 - **“productive” absorptions, which end in fission**
 - **“non-productive” absorptions (in fuel or in structural material), which do not end in fission**
 - **leakage out of the reactor**



Reactor Multiplication Constant

- Self-sustainability of chain reaction depends on relative rates of production and elimination of neutrons.
- Measured by the effective reactor multiplication constant:

$$k_{\text{eff}} = \text{Rate of neutron production} / \text{Rate of neutron loss}$$



Reactor Multiplication Constant

- Three possibilities for k_{eff} :
- $k_{\text{eff}} < 1$: Fewer neutrons being produced than eliminated. Chain reaction not self-sustaining, reactor eventually shuts down. **Reactor is subcritical.**
- $k_{\text{eff}} = 1$: Neutrons produced at same rate as eliminated. Chain reaction exactly self-sustaining, reactor in steady state. **Reactor is critical.**
- $k_{\text{eff}} > 1$: More neutrons being produced than eliminated. Chain reaction more than self-sustaining, reactor power increases. **Reactor is supercritical.**



Critical Mass

- Because leakage of neutrons out of reactor increases as size of reactor decreases, reactor must have a minimum size to work.
- Below minimum size (critical mass), leakage is too high and k_{eff} cannot possibly be equal to 1.
- Critical mass depends on:
 - shape of the reactor
 - composition of the fuel
 - other materials in the reactor.
- Shape with lowest relative leakage, i.e. for which critical mass is least, is shape with smallest surface-to-volume ratio: a sphere.



Reactivity

- Reactivity is a quantity closely related to reactor multiplication constant. Reactivity (ρ) is defined as

$$\rho = 1 - 1/k_{\text{eff}}$$

= (Neutron production-loss)/Neutron production

= **Net relative neutron production**

- “Central” value is 0:
- $\rho < 0$: reactor subcritical
- $\rho = 0$: reactor critical
- $\rho > 0$: reactor supercritical



Units of Reactivity

Reactivity measured in milli-k (mk).

1 mk = one part in one thousand
= 0.001

$\rho = 1$ mk means

neutron production > loss by 1 part in 1000

1 mk may seem small, but one must consider the time scale on which the chain reaction operates.



Control of Chain Reaction

To operate reactor:

- Most of the time we want $k_{\text{eff}} = 1$ to keep power steady.
- To reduce power, or shut the reactor down, we need ways to make $k_{\text{eff}} < 1$:
done by inserting neutron absorbers, e.g. water, cadmium, boron, gadolinium.
- To increase power, we need to make k_{eff} **slightly** > 1 for a short time:
usually done by removing a bit of absorption.



Control of Chain Reaction

- In a reactor, we don't want to make k_{eff} much greater than 1, or > 1 for long time, or power could increase to high values, potentially with undesirable consequences, e.g. melting of the fuel.
- Even when we want to keep $k_{\text{eff}} = 1$, we need reactivity devices to counteract perturbations to the chain reaction. The movement of reactivity devices allows absorption to be added or removed in order to manipulate k_{eff} .
- Every nuclear reactor contains regulating and shutdown systems to do jobs of keeping k_{eff} steady or increasing or decreasing it, as desired.



Concept of Nuclear Cross Section

- **As neutrons diffuse through materials of reactor core, they may enter into number of reactions with nuclei: scattering (elastic or inelastic), absorption, fission, or other reaction.**
- **In reactor physics, rates at which various reactions occur are the prime quantities of interest.**
- **The next discussion introduces concepts which are useful in the calculation of reaction rates.**



Concept of Nuclear Cross Section

- The number of reactions of a particular type i (e.g. scattering, absorption, fission, etc.) which a neutron undergoes per unit distance of travel is called the **macroscopic** cross section for the reaction i , and is denoted Σ_i . It has units of inverse length (e.g. cm^{-1}).



Microscopic Cross Section

- Imagine a monoenergetic beam of neutrons of speed v impinging upon a (very thin) slice of surface area S and thickness Dx of material.
- Beam intensity = $I(x)$ [neutrons.cm⁻²]
- The microscopic cross section σ is the effective area presented to the neutron by 1 nucleus of the material. It depends on the type of nucleus and on the neutron energy.
- σ can be expressed in cm², or, much more appropriately, in units of barn = 10^{-24} cm², or sometimes kilobarn (kb) = 10^{-21} cm².

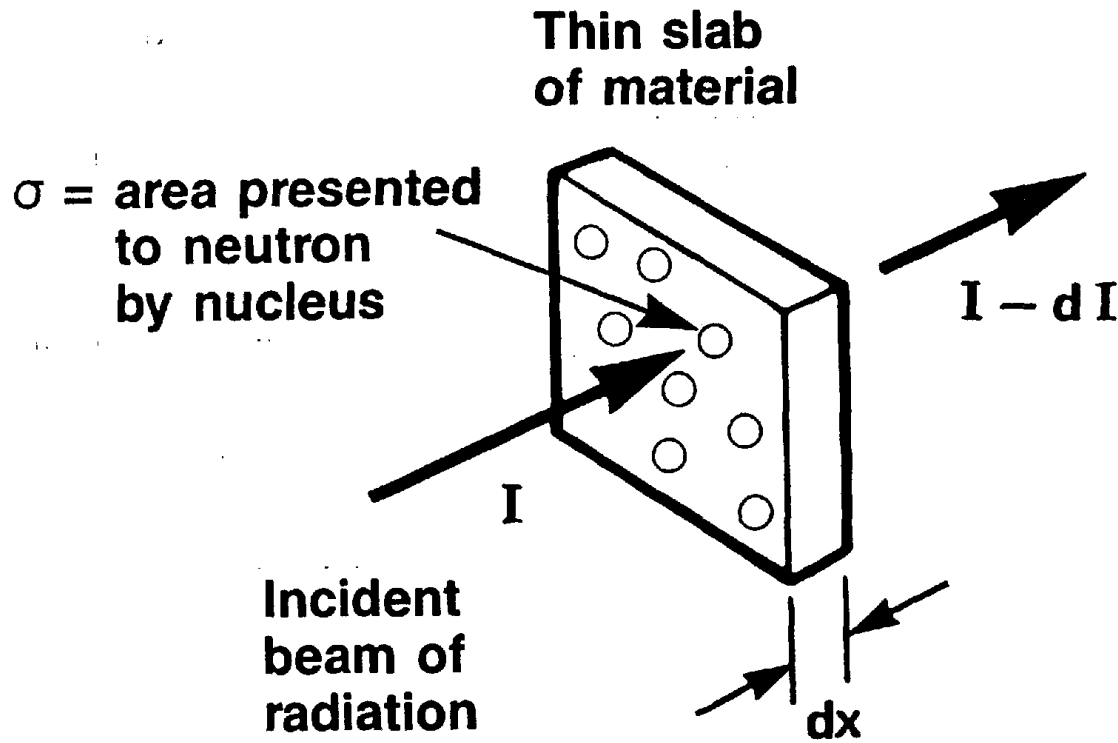

$$- dI = I (N\sigma) dx$$

$$I = I_0 e^{-N\sigma X}$$

$$\Sigma = N\sigma$$

$$\lambda = \frac{1}{\Sigma}$$

Neutron Beam Impinging on a Slice of Material



Macroscopic Cross Section

- Let us consider the number of nuclei in the thin slice of the target.
- If atomic density is N atoms cm^{-3} (which can be determined from the material density and its atomic mass), then the number of nuclei in the slice = $NS\Delta x$.
- If microscopic cross section is σ , then the total area presented to each neutron is $NS\Delta x\sigma$, and
- Probability of the reaction occurring
per incident neutron = $NS\Delta x\sigma/S = N\Delta x\sigma$
- Probability of the reaction occurring
per neutron path length = $N\Delta x\sigma/\Delta x = N\sigma$
- This is called the macroscopic cross section Σ : $\Sigma = N\sigma$
- [Note: If several different types of nuclei are present in the material, then a number of partial products $N\sigma$ for the various nuclide types must be added together to give Σ .]



Miscroscopic & Macroscopic Cross Sections

- The microscopic cross section σ is a basic physical quantity which is determined by experiments of neutron beams of various energies on target materials.
- Once σ is known, then the macroscopic cross section Σ can be obtained from N and σ .
- Both σ and Σ depend on the material, the neutron energy or speed, and the type of reaction.
- The macroscopic cross sections for scattering, absorption, fission are denoted Σ_s , Σ_a , and Σ_f respectively.
- The total cross section Σ_{tot} measures the total number of all types of reaction per unit distance: $\Sigma_{tot} = \Sigma_s + \Sigma_a \dots$
- (Note that the fission cross section is included in the absorption cross section, since it occurs following a neutron absorption.)



Number of Reactions in a Path Length

- For a reaction of type i , and from the definition of the associated macroscopic cross section Σ_i , the total number of reactions i that 1 neutron is expected to undergo in a projected path length s of travel is given by $\Sigma_i \cdot s$.
- In addition, the total number of reactions of a group of neutrons will also be $\Sigma_i \cdot s$ if s is the total cumulative projected path length of all the neutrons.



Concept of Neutron Flux

- Imagine all neutrons in unit volume at a given instant.
- Let neutron population density be n neutrons/cm³.
- Sum all the distances (path lengths) which would be traversed by these neutrons per unit time. This is the concept of total neutron flux, denoted ϕ . Units are (neutrons/cm³).cm/s, i.e., neutrons.cm⁻²s⁻¹.
- In the (hypothetical) case in which all neutrons are travelling at the same speed v , the flux is the product of the density n of the neutron population and the speed v :

$$\phi(v) = nv$$

- [For distribution of neutron speeds, integrate over v]

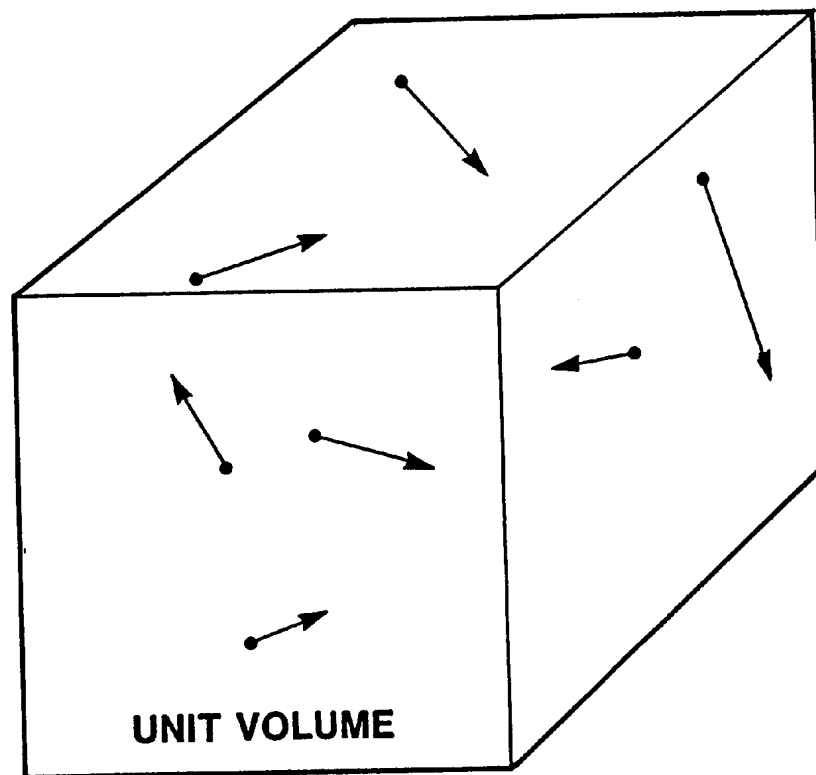

Each point represents a neutron in the unit volume. The length of the arrow is equal to the speed of the neutron. The flux is the sum of all arrow lengths.

Concept of Neutron Flux



Calculating Reaction Rates

- Putting together the concepts of neutron flux and cross section, one can calculate reaction rates.
- Reaction rate for given process at neutron speed v (per unit volume per unit time) is the product of total path length of neutrons (flux) and macroscopic cross section:

- Reaction rate (per unit volume)

$$\text{for neutrons of speed } v = \Sigma(v)\phi(v)$$

- If there is a distribution of neutron speeds, the reaction rate is integrated over the distribution v .

$$\phi \equiv \int n(v)v dv$$



Concept of Irradiation

- The irradiation of a material, denoted ω , is a measure of the time spent by the material in a given neutron flux. Mathematically, it is defined as the product of flux by time:

$$\omega = \phi \cdot t$$

- The units of irradiation are neutrons/cm², or more conveniently, neutrons per thousand barns (neutrons per kilobarn [n/kb]).



Fuel Burnup

- Fuel burnup = (cumulative) quantity of fission energy produced per mass of nuclear fuel during its residence time in the core.
- The two most commonly used units for fuel burnup are Megawatt-hours per kilogram of uranium, i.e., MW.h/kg(U), and
Megawatt-days per Megagram (or Tonne) of uranium, i.e., MW.d/Mg(U).
- $1 \text{ MW.h/kg(U)} = 1,000/24 \text{ MW.d/Mg(U)}$
 $= 41.67 \text{ MW.d/Mg(U)}$
- Burnup is almost linear with irradiation.

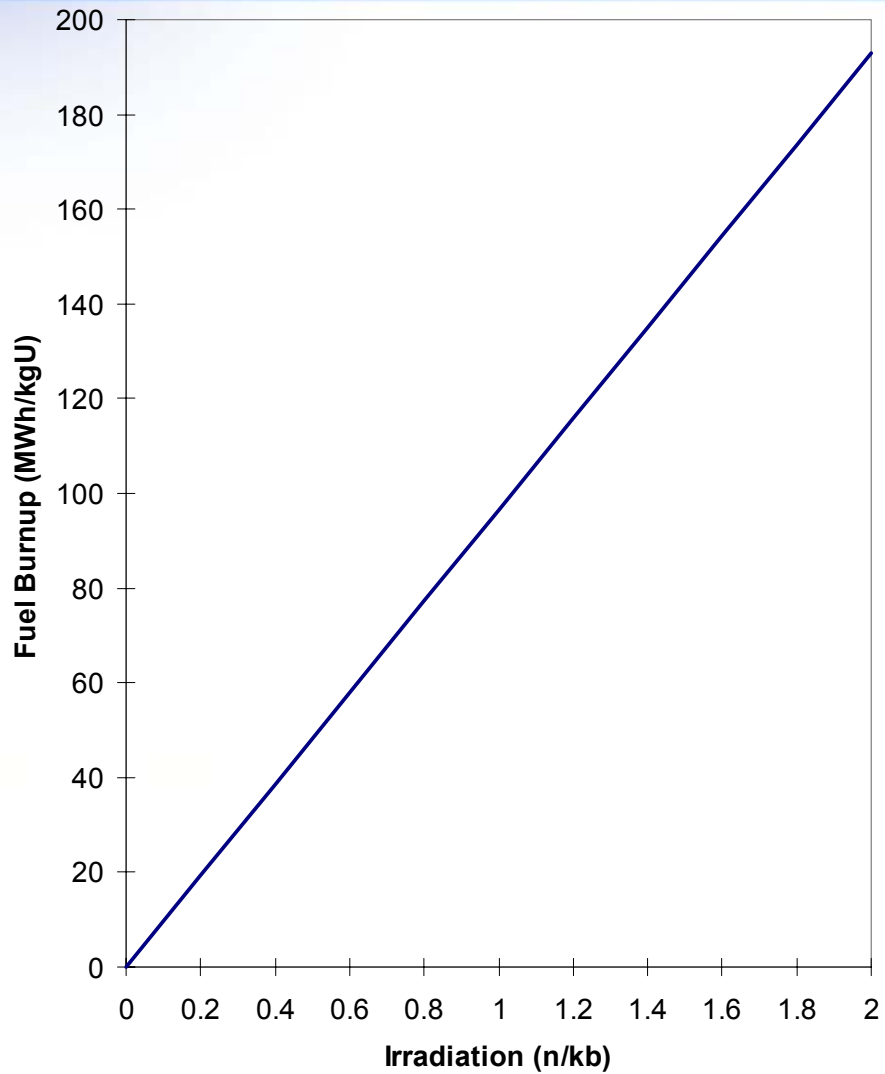

Relationship Between Irradiation and Burnup Pg 44



Fuel Burnup

- Fuel burnup is an important economic quantity: essentially the inverse of fuel consumption [units, e.g., Mg(U)/GW(e).a].
- For a given fissile content, a high burnup signifies low fuel consumption, and therefore a small refuelling-cost component.
- Note, however, that true measure of reactor's efficiency is uranium utilization, the amount of uranium "from the ground" needed to produce a certain amount of energy.
- Typical fuel burnup attained in CANDU 6 = 7500 MW.d/Mg(U), or 175-180 MW.h/kg(U).
- However, burnup depends on operational parameters, mostly the moderator purity.



Delayed Neutrons and Neutron Kinetics

- Any imbalance between neutron production and loss causes the neutron population to increase (or decrease) from one generation to the next
- The rate at which the neutron population (and, consequently, the power) will change will depend on the mean generation time T , the average time interval between successive neutron generations



Simplistic treatment of Power Changes

- Simplistic treatment of kinetics: power varies exponentially with reactivity and with time (in units of generation time T):

$$P = P_0 \exp\left(\frac{\rho t}{T}\right)$$



Delayed Neutrons

- **Simplistic treatment does not account for delayed neutrons.**
- **Neutrons produced in fission are either prompt or delayed (because produced in β -decay of some fission products).**
- **The prompt-neutron lifetime Λ (average time interval between birth of a neutron and its absorption in a subsequent fission reaction) in the CANDU lattice is approximately 0.9 millisecond.**



Delayed Neutrons

If no delayed neutrons, mean generation time = prompt-neutron lifetime.

In that case, reactivity of 1 milli-k would lead to a power increase by a factor of 3 per second, a very fast rate of change!

(In LWRs, L is about 30 times shorter! The rate of change of power would then be 30 times as great for the same reactivity.)



Delayed Neutrons

Delayed neutrons, although only ~0.6 %, reduce rate of power change considerably.

Delayed neutrons are produced in beta decay of fission products (6 groups of precursors) with half-lives from 0.2 s to 50 s.

In CANDU, also photoneutrons; 11 groups of precursors, time constants = hundreds to tens of thousands of seconds.



Table 1 (Part 1)
Typical 6-Precursor-Group Data for Direct Delayed Neutrons

Fissioning Nuclide	Fractional Group Yield	Decay Constant λ (s ⁻¹)	Direct Delayed Neutron Yield (ν_d) and Fraction (β)
²³⁵ U Thermal Fission	0.0380	0.0133	$\nu_d = 0.0166 \pm 3\%$ $\beta = 0.00682 \pm 3\%$
	0.1918	0.0325	
	0.1638	0.1219	
	0.3431	0.3169	
	0.1744	0.9886	
	0.0890	2.9544	
²³⁸ U Fast Fission	0.0139	0.0136	$\nu_d = 0.0450 \pm 4.4\%$ $\beta = 0.01584 \pm 4.4\%$
	0.1128	0.0313	
	0.1310	0.1233	
	0.3851	0.3237	
	0.2540	0.9060	
	0.1031	3.0487	



Table 1 (Part 2)
Typical 6-Precursor-Group Data for Direct Delayed Neutrons

Fissioning Nuclide	Fractional Group Yield	Decay Constant λ (s ⁻¹)	Direct Delayed Neutron Yield (ν_d) and Fraction (β)
²³⁹ Pu Thermal Fission	0.0306	0.0133	$\nu_d = 0.00654 \pm 4\%$ $\beta = 0.002278 \pm 4\%$
	0.2623	0.0301	
	0.1828	0.1135	
	0.3283	0.2953	
	0.1482	0.8537	
	0.0479	2.6224	
²⁴¹ Pu Thermal Fission	0.0167	0.0137	$\nu_d = 0.0152 \pm 7.3\%$ $\beta = 0.00516 \pm 7.3\%$
	0.2404	0.0299	
	0.1474	0.1136	
	0.3430	0.3078	
	0.1898	0.8569	
	0.0627	3.0800	



Table 2
Group Yields and Half-Lives for 11 Groups of Photoneutrons

Group #	Fractional Group Yield	Half-Life
1	0.0011	307.6 h (1.107*10⁶ s)
2	0.0023	53.0 h (1.908*10⁵ s)
3	0.0073	4.4 h (1.584*10⁴ s)
4	0.0527	5924 s
5	0.0466	1620
6	0.0757	462.1
7	0.1576	144.1
8	0.0448	55.7
9	0.2239	22.7
10	0.1940	6.22
11	0.1940	2.3



Delayed Neutrons

- **“Effective” (weighted-average) mean generation time ~ 0.1 s, ~ 100 times longer than prompt-neutron lifetime.**
- **Reactivity of 1 milli-k then leads to increase in power by only about 1.01 per second, compared to 3 per second without delayed neutrons.**
- **Clear that delayed neutrons have large influence on evolution of power in transients and facilitate reactor control considerably.**
- **However, note “exponential” treatment is inadequate. Correct treatment involves solving coupled set of equations for the time-dependent flux distribution and the concentrations of the individual delayed-neutron precursors.**



CANDU Modular Design

- The Figure “Schematic Face View of CANDU 6 Reactor” shows that the CANDU design is modular, with fuel channels set on a square lattice of lattice pitch equal to 28.575 cm.



END VIEW OF REACTOR SHOWING PRINCIPAL CALANDRIA DIMENSIONS,
FUEL CHANNELS AND BOUNDARY OF INNER FUEL ZONE

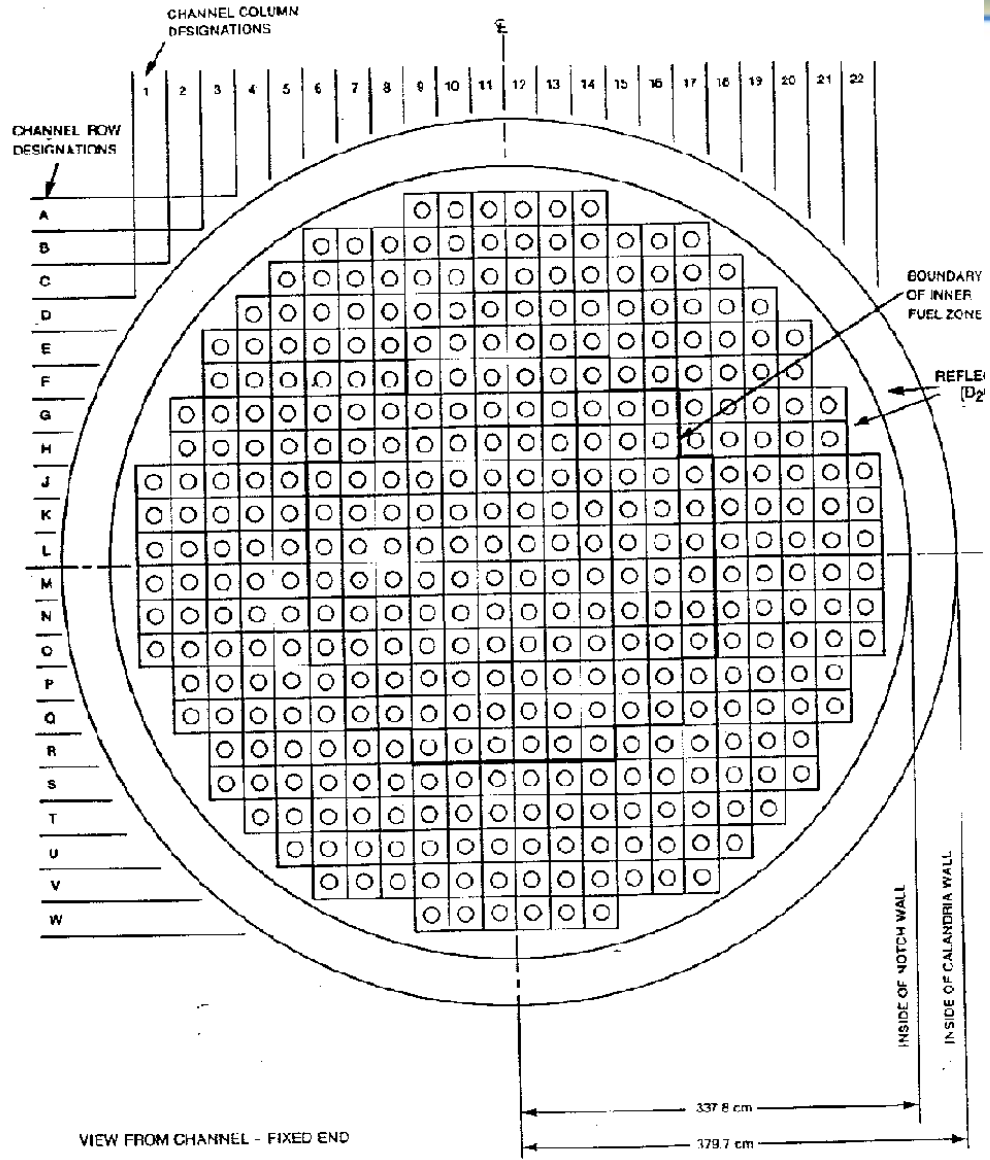

Schematic Face View of CANDU 6 Reactor



CANDU Basic Lattice Cell

- The Figure “Face View of Basic CANDU Lattice Cell” shows (not to scale) the basic lattice cell in CANDU, which has dimensions of 1 lattice pitch by 1 lattice pitch (28.575 cm x 28.575 cm) by 1 fuel-bundle length (49.53 cm) – the 3rd dimension is not shown in the figure. There are twelve fuel bundles in each fuel channel.
- The next few sections describe the various components of the lattice cell.

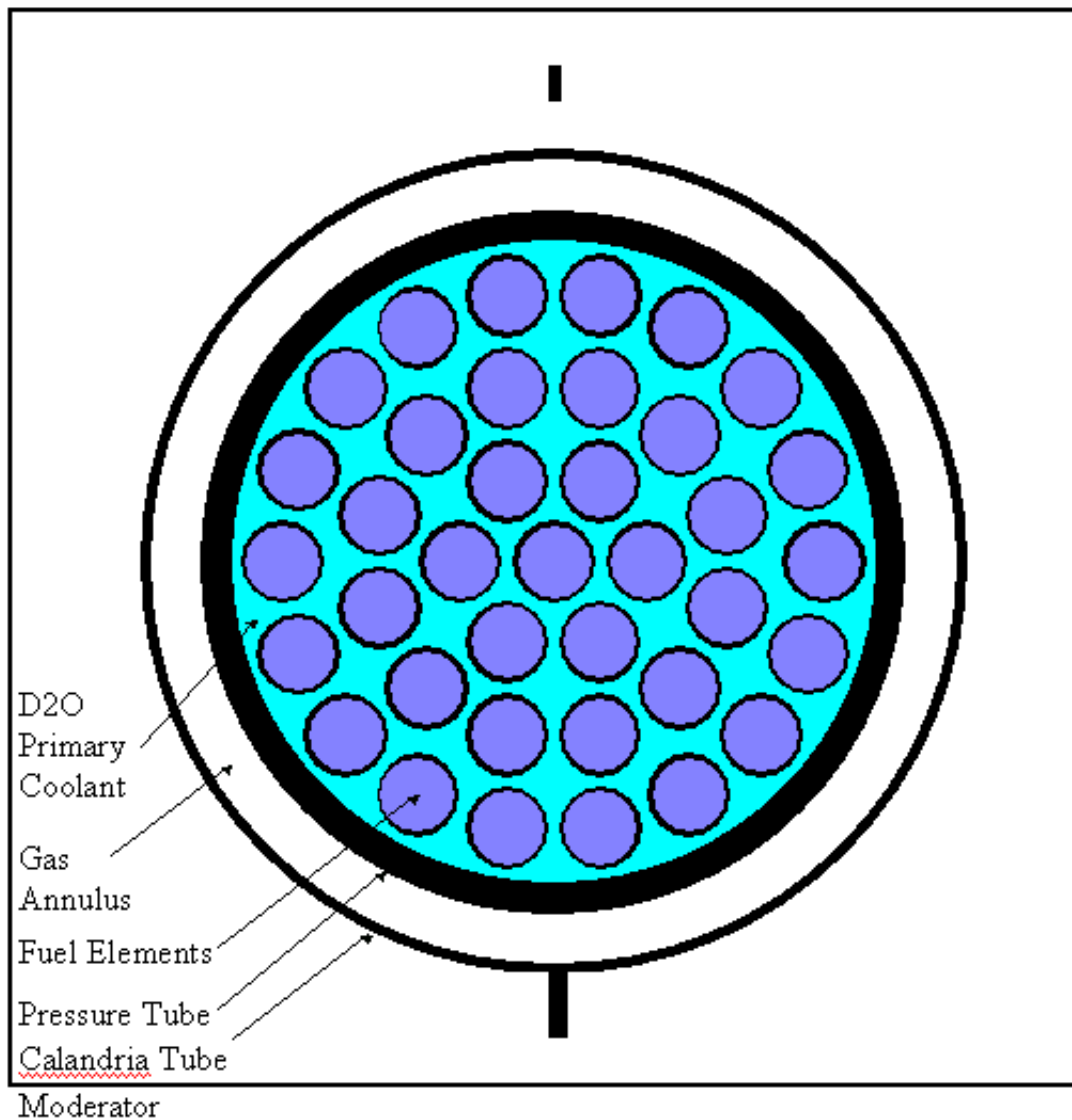

Face View of CANDU Basic-Lattice Cell



Moderator

- Desirable property for a moderator is the ability to thermalize neutrons in as few collisions as possible.
- When the number of collisions required for thermalization is smaller, the average loss of neutron energy per collision is greater, and the probability is enhanced that the neutron will miss the resonance-absorption energy range (or much of it) during moderation (see next Figure).
- Following Figure shows the average number of collisions needed for various moderators to thermalize a fission neutron.

EFFECT OF MODERATOR ON NEUTRON ENERGY DURING SLOWING-DOWN

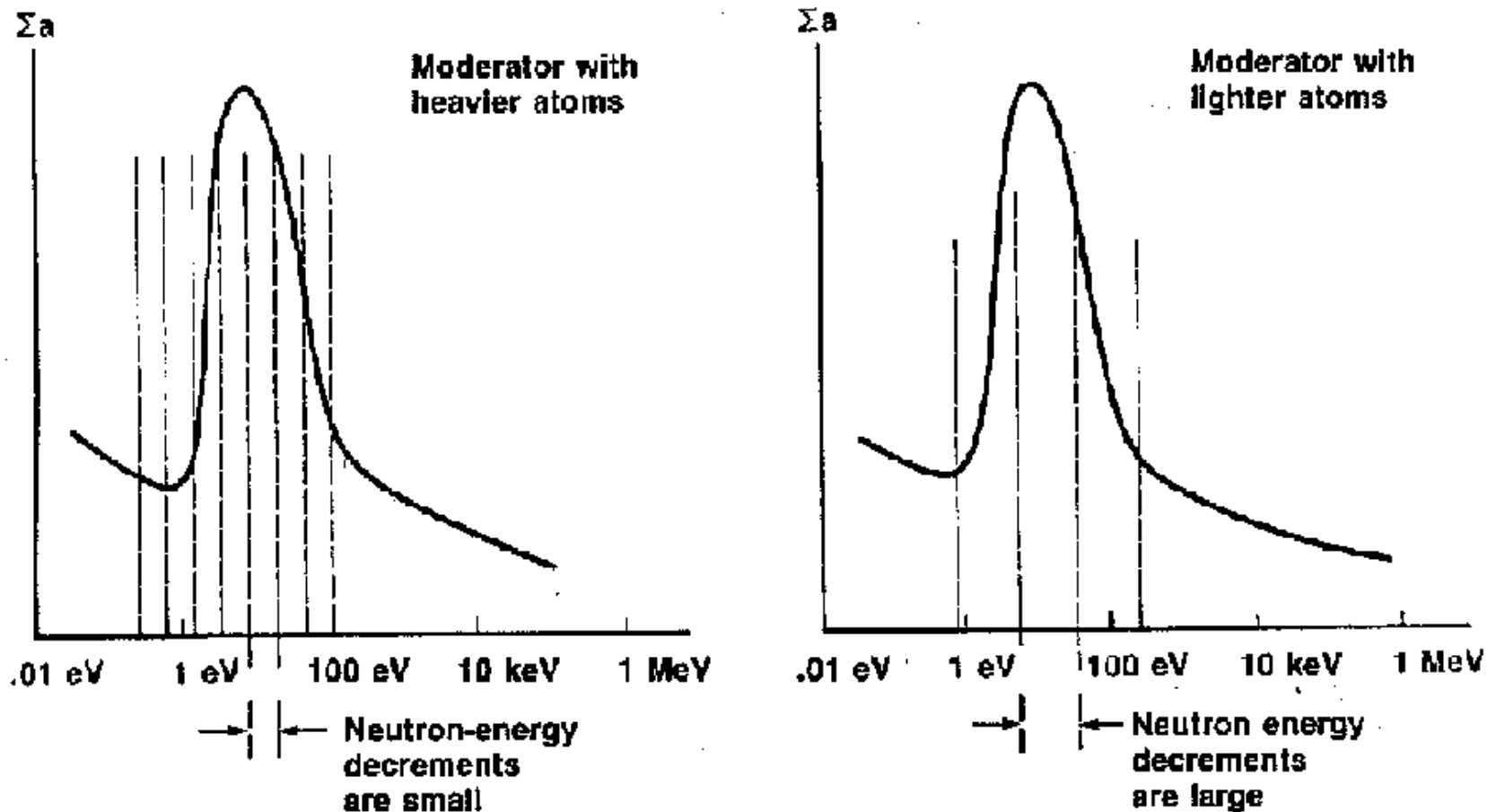

Number of Collisions and Energy Loss per Collision During Moderation



Moderator	Number of Collisions
H	18
D	25
He	43
Li	67
Be	86
C	114

Number of Collisions to Thermalize a Fission Neutron



Lumping of Fuel

- **Another feature which helps to reduce the neutron capture in fuel resonances is the lumping of the fuel in fuel channels.**
- **This enhances the probability of fission neutrons being slowed down in the moderator volume between fuel channels (see next Figure), and therefore reducing the probability of neutrons interacting with the fuel when in the resonance-energy range.**

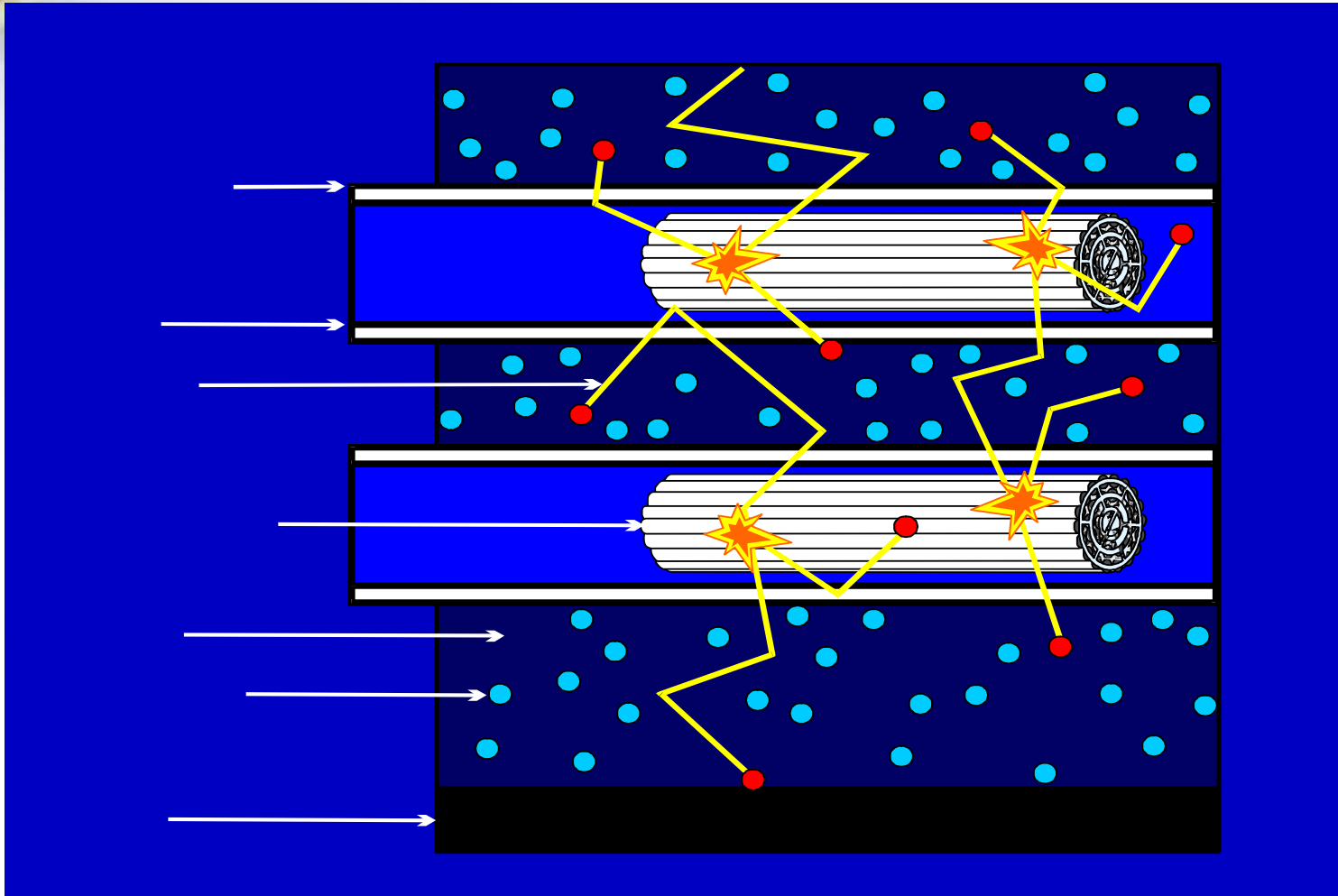

Fission Neutrons Slowed in Moderator Region



Moderator

- A good index of performance for moderators is the moderating ratio, the ratio of the slowing-down power of the material to its neutron absorption cross section:

$$\text{Moderating ratio} = \frac{\text{Slowing - down power}}{\text{Absorption cross section}} = \frac{\xi \Sigma_s}{\Sigma_a}$$

where ξ is the mean logarithmic energy decrement per collision.

- See comparison in next Figure.



Moderator	Moderating Ratio
Light Water	62
Carbon (Graphite)	165
Heavy Water	5000

Moderating Ratio of Various Moderators



Fuel

- Fuel in most reactors is in form of UO_2 , a very strong ceramic.
- Natural uranium is used in all currently operating CANDU reactors - very convenient for countries which wish not to have to rely on expensive, and most probably foreign, enrichment technology.
- However, CANDU design is very flexible and allows use of advanced fuel cycles, using slightly enriched uranium (SEU), recovered uranium (RU), mixed-oxide fuel (MOX), thorium fuels (Th), and others (DUPIC, actinide burning).
- These can be introduced into CANDU with few or no hardware changes, when the option becomes attractive.



Fuel

- **CANDU fuel is of very simple design.**
- **Elements of length ~48 cm**
- **Each element contains ~ 20-25 UO_2 pellets encased in a zirconium sheath.**
- **A number of fuel elements are assembled together to form a bundle of length ~50 cm. The elements are held together by bundle end plates.**
- **A fuel bundle contains about 20 kg of uranium.**
- **The CANDU fuel bundle contains only 7 different components and is short, easy to handle, and economical.**

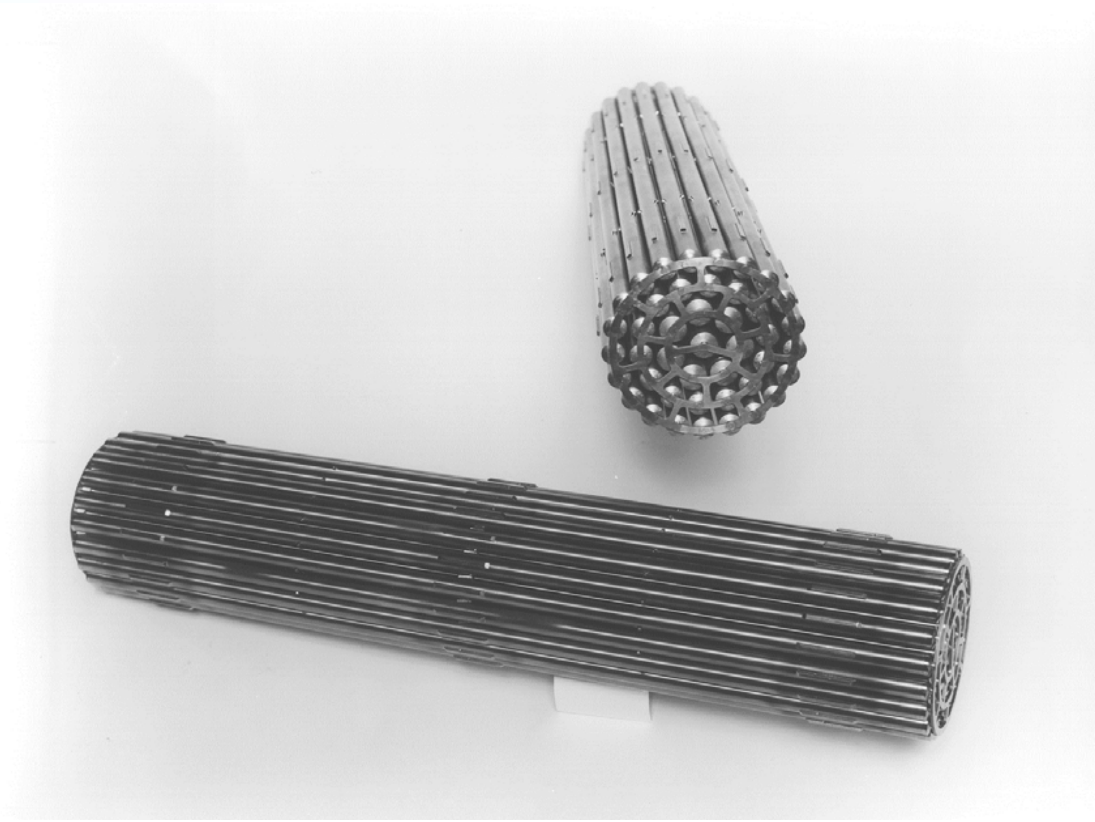

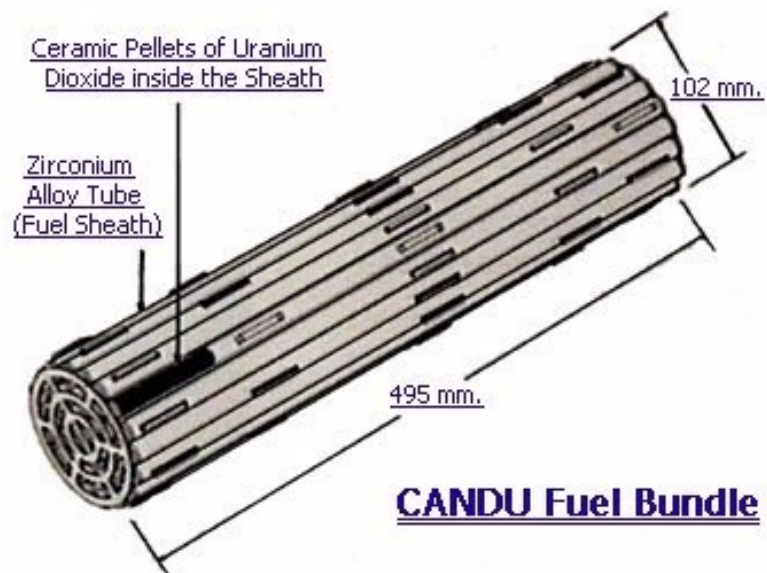



Pellets

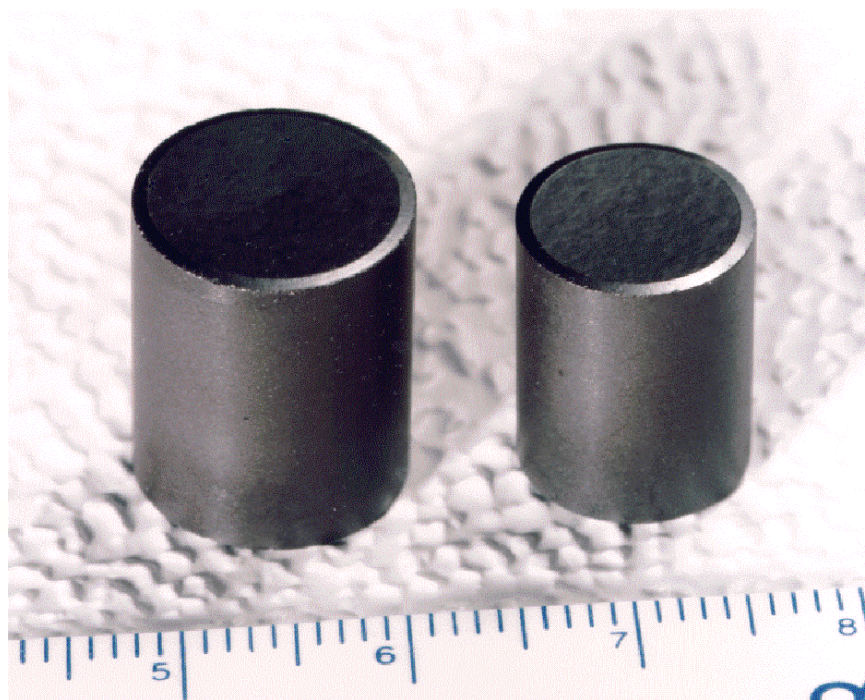



Fuel

- Next Figure shows various fuel-bundle designs.
- Only two bundle types are used in present-generation CANDUs: 28-element bundle (in Pickering) and 37-element bundle (in Bruce, Darlington and CANDU 6).
- 28-element bundle has a smaller ratio of sheath mass to fuel mass than the 37-element bundle, which gives the 28-element bundle a reactivity advantage.
- On other hand, 37-element bundle has better thermalhydraulic properties: greater fuel subdivision, larger number of pins, smaller-diameter pins provide better heat-removal capability.
- Thus, 37-element bundle can operate at higher power than 28-element bundle. This tends to further reduce the reactivity of 37-element bundle, but allows a higher total reactor power for the same mass of fuel, an important economic advantage.

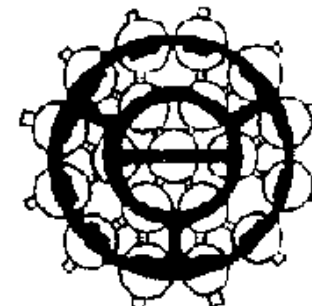
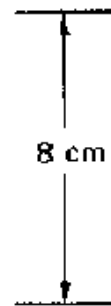
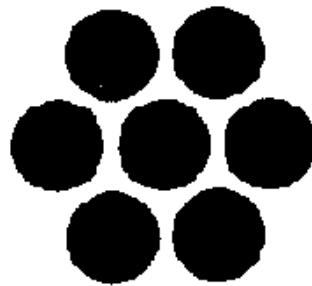

Reactor	N.P.D.		N.P.D. & DOUGLAS PT.	
Number of Rods/Bundle	7		19	19
Rod Diameter mm	25.4		15.25	15.22
Nominal Bundle Power kW	220		221	420
Mass Ratio UO ₂ /Zircaloy	11.1		10.2	10.1

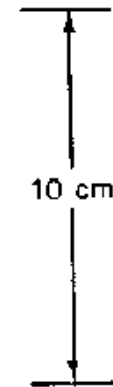
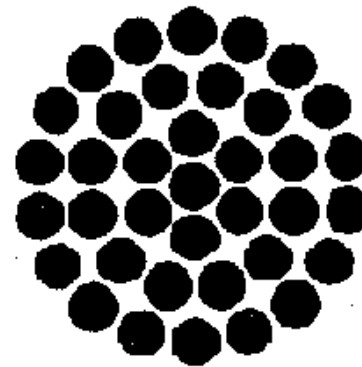
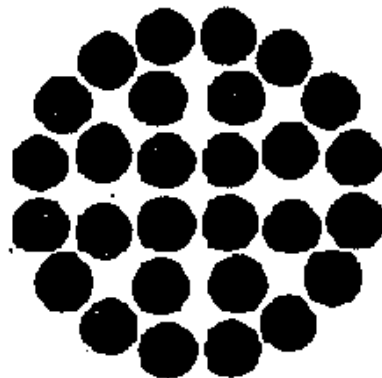

Reactor	PICKERING		BRUCE & 600 MW	
Number of Rods/Bundle	23		37	37
Rod Diameter mm	15.19		13.08	13.08
Nominal Bundle Power kW	640		900	800
Mass Ratio UO ₂ /Zircaloy	11.1		9.4	9.4

Various Fuel-Bundle Designs - to 37-Element Fuel



CANFLEX Fuel

- The CANFLEX fuel design (next Figure) has been under development as the fuel bundle for the future.
- The CANFLEX bundle has 43 elements, with the outer two rings of elements being of smaller diameter than the inner 7 elements. The CANFLEX bundle features improved thermalhydraulic properties and 20% lower maximum element-power ratings than 37-element fuel, for the same bundle power.
- In 1998-2000, a demonstration irradiation of 24 CANFLEX fuel bundles was initiated in the Pt. Lepreau CANDU-6 reactor.

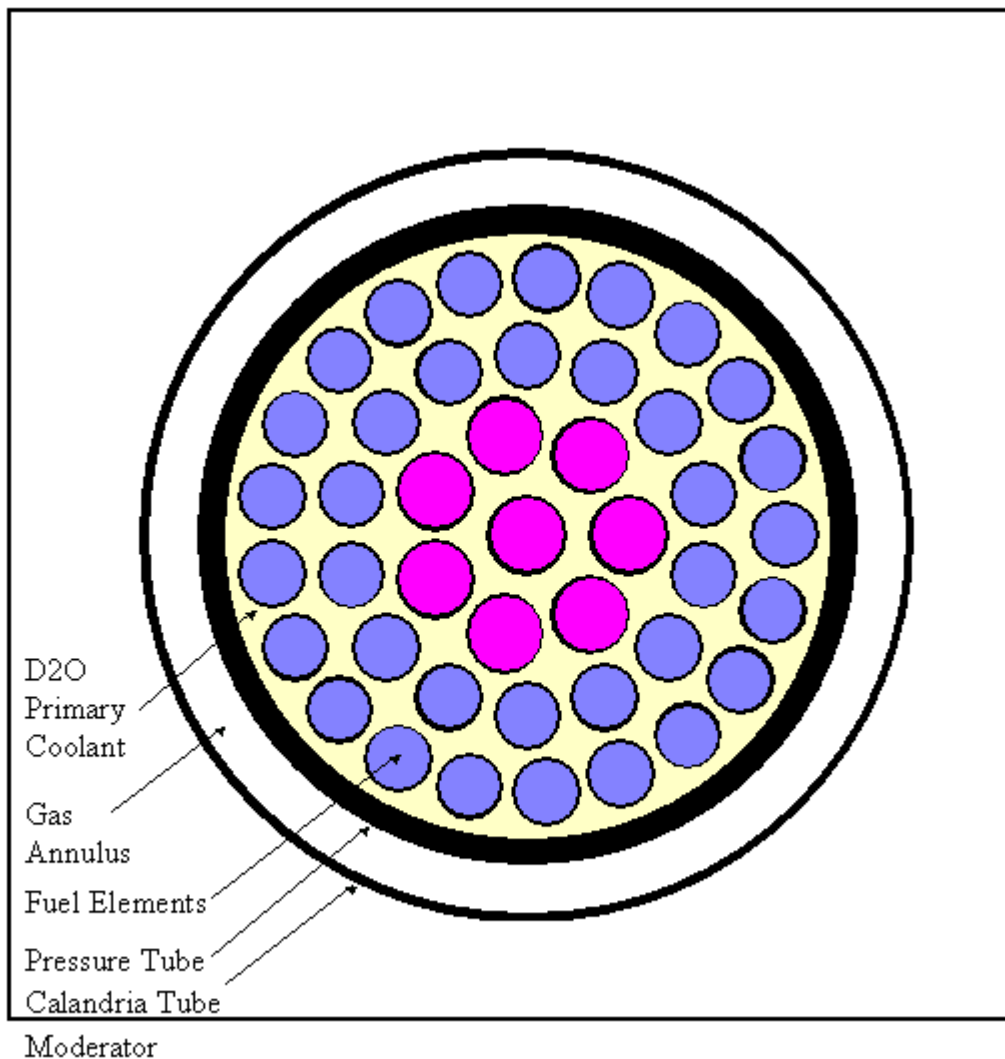

The CANFLEX 43-Pin Fuel Bundle



Coolant

- In all commercial CANDU reactors, heavy water is used as the coolant in the primary heat-transport system, to further improve neutron economy.
- However, prototype CANDUs have been built using boiling light water or an organic liquid as coolant (Gentilly-1 and WR-1 respectively). The organic coolant, in particular, allows higher temperatures and greater efficiency of conversion of heat to electricity.



Pressure-Tube Concept

- A major CANDU characteristic is the pressure-tube design.
- Liquid coolant must be kept at high pressure, otherwise it would boil. The heat-transport-system pressure in CANDU is ~100 atmospheres.
- Choice is between pressure vessel (PWR) and pressure tubes (CANDU).
- Pressure tubes are made of an alloy of zirconium and 2.5% niobium.
- CANDU first design principles shown in next slide.



CANDU First Design Principles

- **Use heavy-water as moderator (and coolant): maximizes neutron economy, allows natural U**
- **Circulate coolant in pressure tubes: allows low-pressure calandria, no large pressure vessel**
- **Make use of on-power refuelling: further enhances neutron economy, provides other advantages**



Fuel Burnup and Effect of Operating Conditions

- **The exit fuel burnup attained in the reactor depends on the operational parameters of the core.**
- **The burnup is influenced by any quantity which affects the core reactivity.**
- **Any neutron loss or parasitic absorption which reduces the lattice reactivity will have a negative effect on the attainable fuel burnup.**
- **The relationship between reduction in core reactivity and loss of burnup is found to be:**

1 milli-k reduction in core reactivity

→ 2.88 MW.h/kg(U) loss in burnup

= 120 MW.d/Mg(U) loss in burnup



Fuel Burnup and Effect of Operating Conditions

- **Examples of factors which affect the reactivity, and therefore the attainable fuel burnup, are as follows:**
 - higher moderator purity increases burnup (reactivity coefficient of moderator purity = ~ 34 milli-k/atom % purity)
 - higher coolant purity also increases burnup (much less than higher moderator purity; reactivity coefficient of coolant purity = ~ 3 milli-k/atom % purity)
 - moderator poison decreases burnup (boron reactivity coefficient = ~ 8 milli-k/ppm(B))
 - reflector decreases leakage and increases burnup
 - thicker pressure or calandria tubes decrease burnup
 - higher ratio of fuel-sheath mass to fuel mass in a bundle (everything else being equal) decreases burnup
 - lower moderator temperature increases burnup
 - flattening the power distribution increases leakage and decreases burnup.



Long-Term Reactivity Control

- For long-term maintenance of reactivity:
- **Refuelling** is required because reactivity eventually decreases as fuel is irradiated: fission products accumulate and total fissile content decreases.
- **In CANDU 6, average refuelling rate ~ 2 channels per Full-Power Day (FPD), using the 8-bundle-shift refuelling scheme (8 new bundles pushed in channel, 8 irradiated bundles pushed out).**
- Selection of channels is the job of the station physicist.



Reactor Regulating System

- The reactivity devices used for control purposes by the Reactor Regulating System (RRS) in the standard CANDU-6 design are the following:
- 14 liquid-zone-control compartments (H₂O filled)
- 21 adjuster rods
- 4 mechanical control absorbers
- moderator poison.



Special Safety Systems

- There are in addition two spatially, logically, and functionally separate special shutdown systems (SDS):
- SDS-1, consisting of 28 cadmium shutoff rods which fall into the core from above
- SDS-2, consisting of high-pressure poison injection into the moderator through 6 horizontally oriented nozzles.
- Each shutdown system can insert **> 50 mk of negative reactivity** in approximately 1 s.
- Next Figure summarizes the reactivity worths and reactivity-insertion rates of the various CANDU reactivity devcies.



REACTIVITY WORTHS OF CANDU REACTIVITY DEVICES

Function	Device	Total Reactivity Worth (mk)	Maximum Reactivity Rate (mk/s)
Control	14 Zone Controllers	7	±0.14
Control	21 Adjusters	15	±0.10
Control	4 Mechanical Control Absorbers	10	±0.075(driving) -3.5 (dropping)
Control	Moderator Poison	—	-0.01 (extracting)
Safety	28 Shutoff Units	-80	-50
Safety	6 Poison-Injection Nozzles	>-300	-50



CANDU Reactivity Devices

- All reactivity devices are located or introduced into guide tubes permanently positioned in the low-pressure moderator environment.
- These guide tubes are located interstitially between rows of calandria tubes (see next Figure).
- There exists no mechanism for rapidly ejecting any of these rods, nor can they drop out of the core. This is a distinctive safety feature of the pressure-tube reactor design.
- Maximum positive reactivity insertion rate achievable by driving all control devices together is about 0.35 mk/s, well within the design capability of the shutdown systems.
- See Plan, Side, and End views of device locations in following Figures.

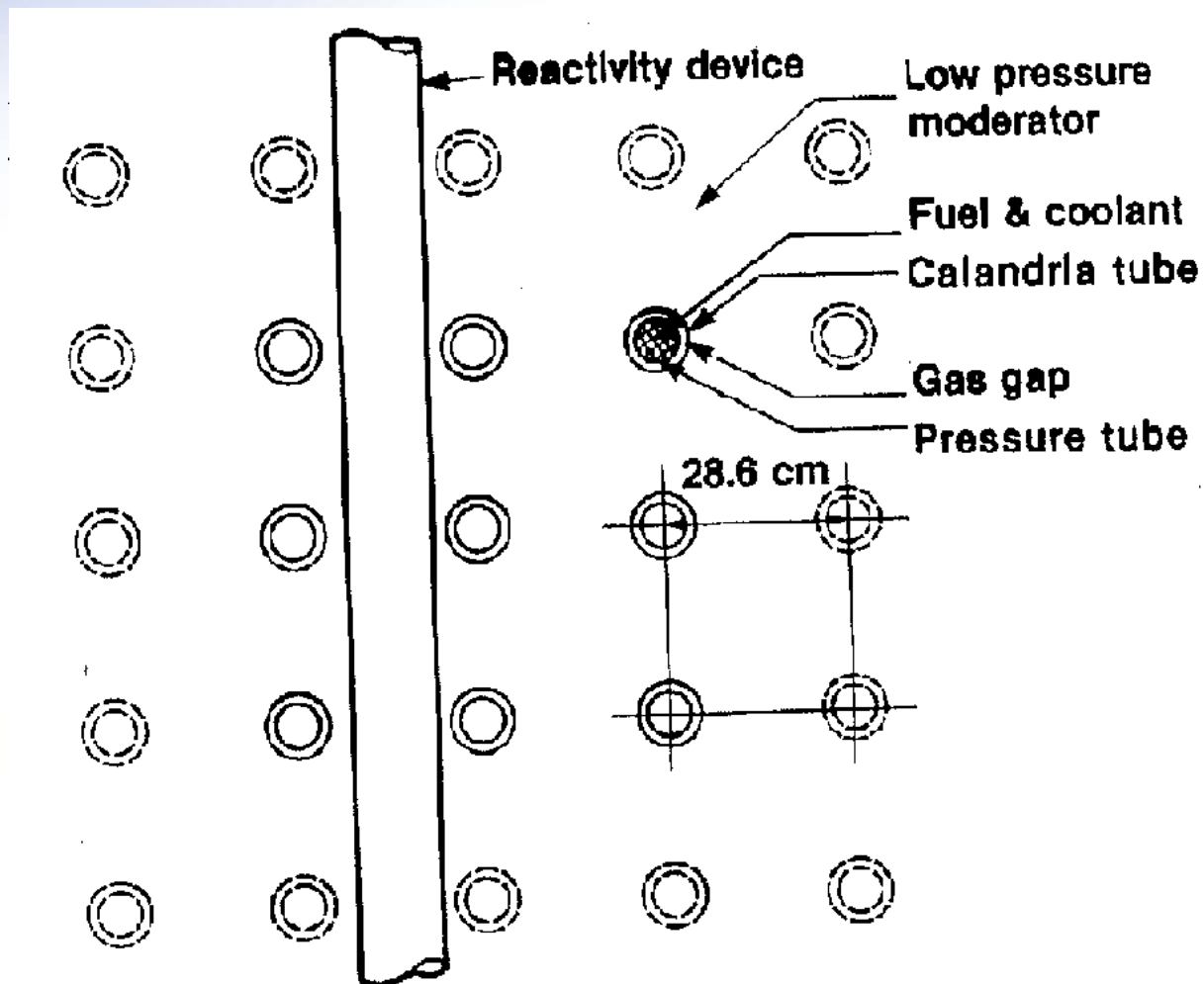

Interstitial Positioning of Reactivity Devices

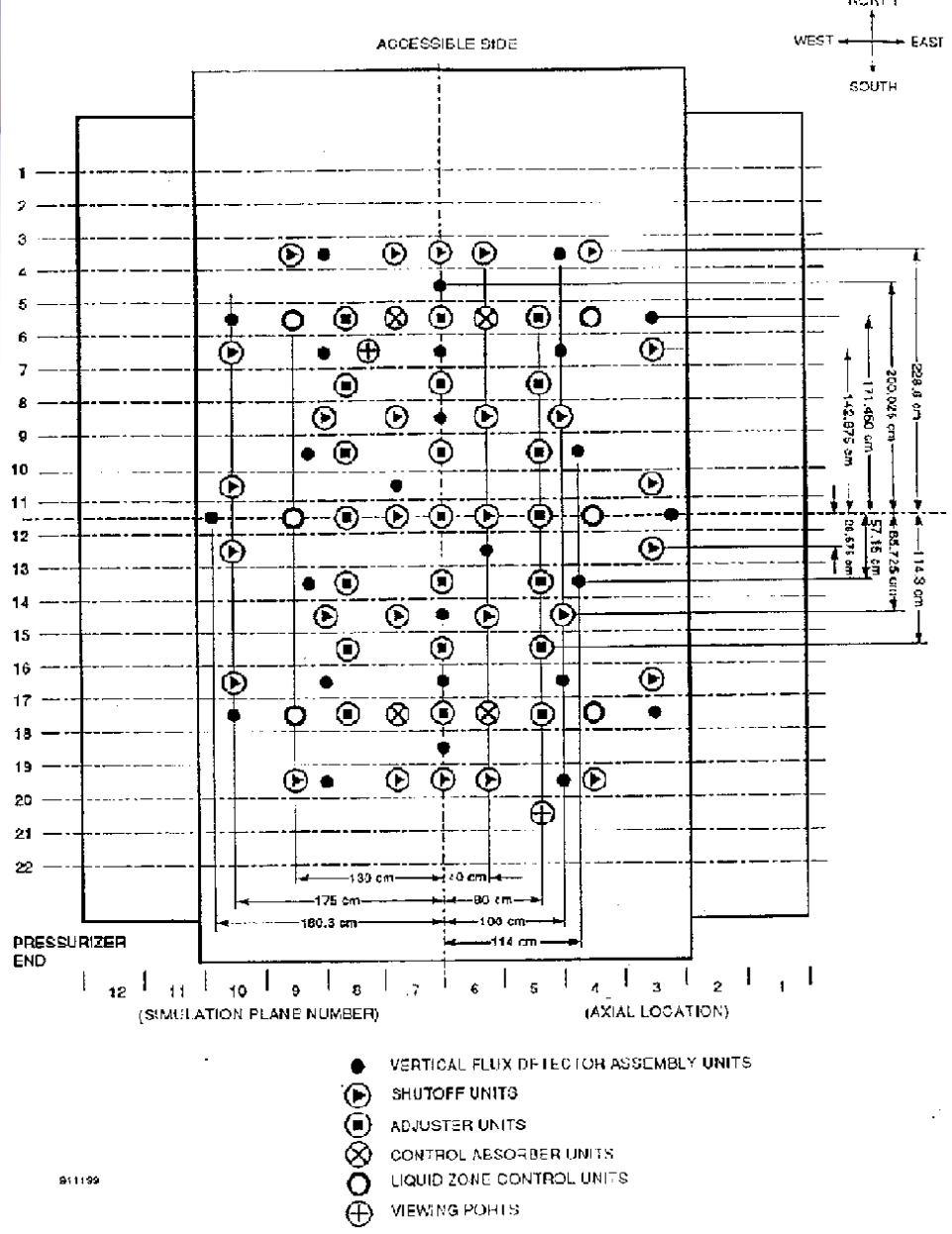

Plan View of Reactivity Device Locations

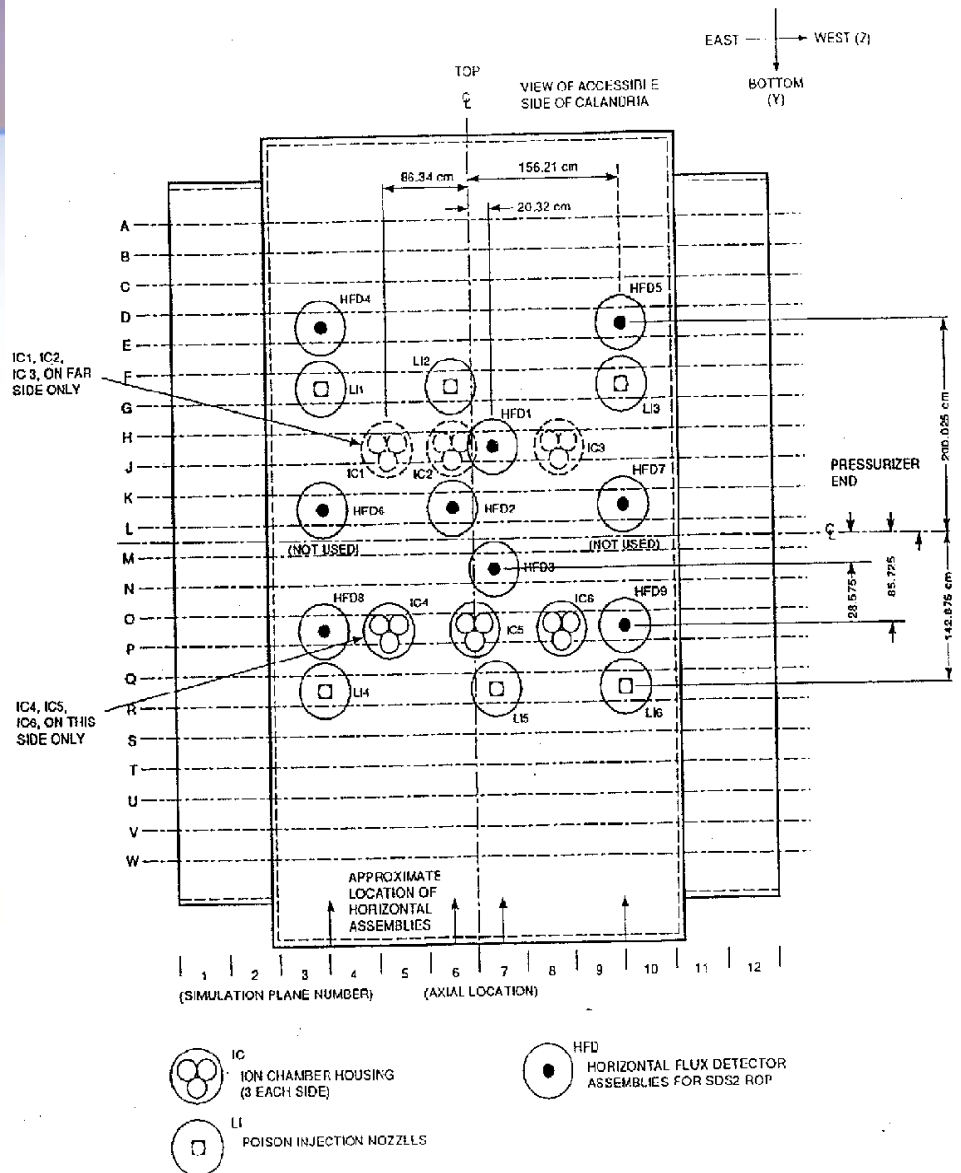

910424

Side-Elevation View of Reactivity-Device Locations 27

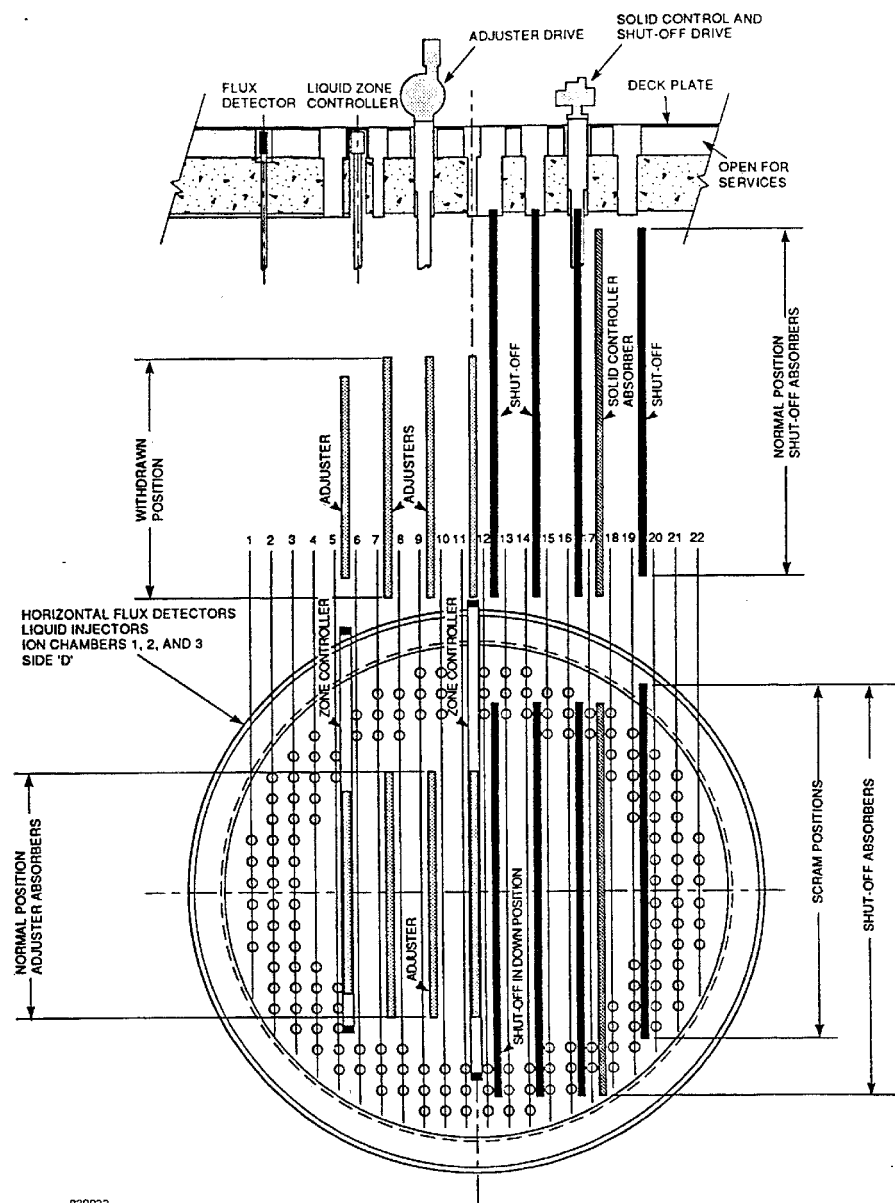

End-Elevation View of Reactivity-Device Locations



Liquid Zone Controllers

For fine control of reactivity:

14 zone-control compartments, containing variable amounts of light water (H_2O used as absorber!)

The water fills are manipulated:

- all in same direction,
 - to keep reactor critical for steady operation, or
 - to provide small positive or negative reactivity to increase or decrease power in a controlled manner
- differentially, to **shape** 3-d power distribution towards desired reference shape



Liquid Zone-Control Units

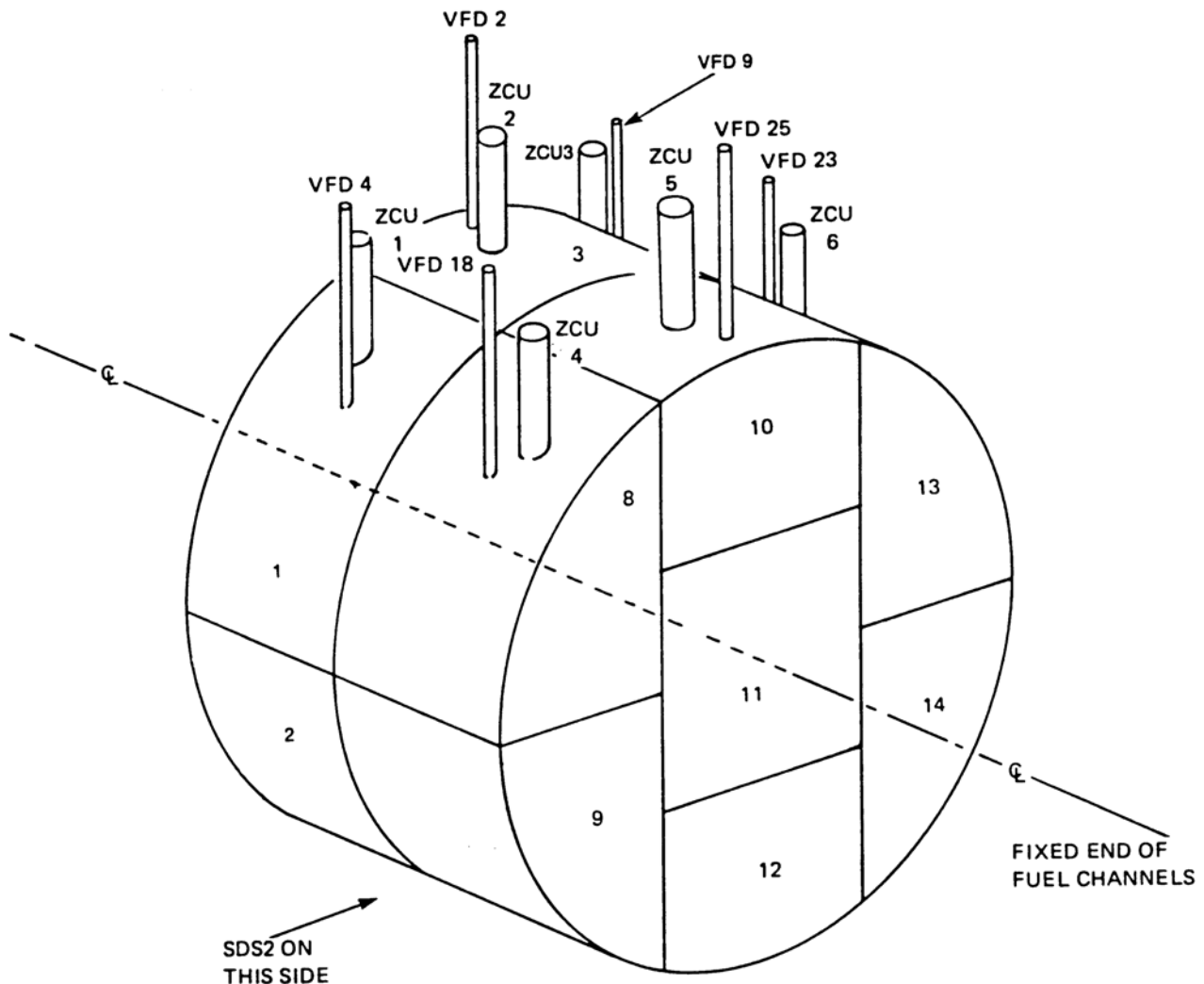



Liquid Zone-Control Compartments



2 3 4 5 6 7 8 9 10 11 12 13 14 15 16 17 18 19 20 21 22 23 24 25 26 27 28 29 30 31 32 33 34 35 36

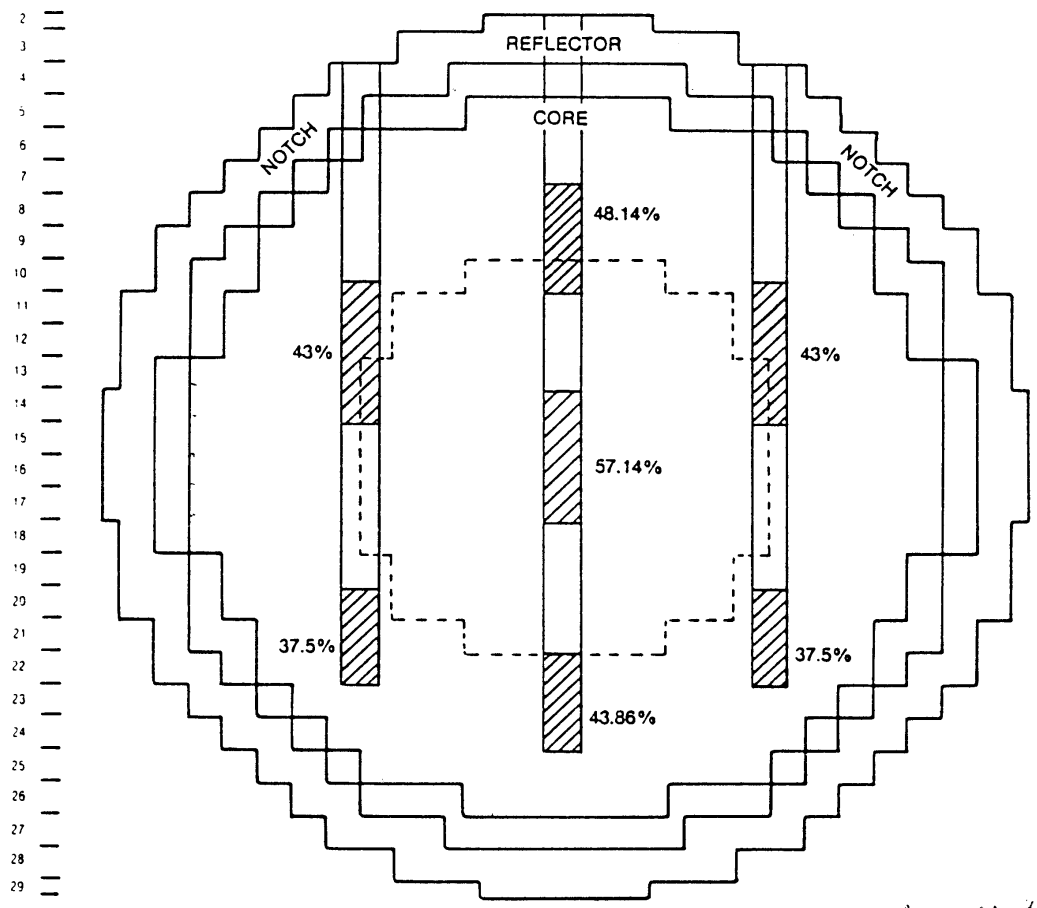

----- INNER CORE OUTER CORE BOUNDARY

Average core level
= 44.3 %



Mechanical Control Absorbers

- For fast power reduction:
- **4 mechanical absorbers (MCA)**, tubes of cadmium sandwiched in stainless steel – physically same as shutoff rods.
- The MCAs are normally parked fully outside the core under steady-state reactor operation.
- They are moved into the core only for rapid reduction of reactor power, at a rate or over a range that cannot be accomplished by filling the liquid zone-control system at the maximum possible rate.
- Can be driven in pairs, or all four dropped in by gravity following release of an electromagnetic clutch.

X = Mechanical Control Absorbers

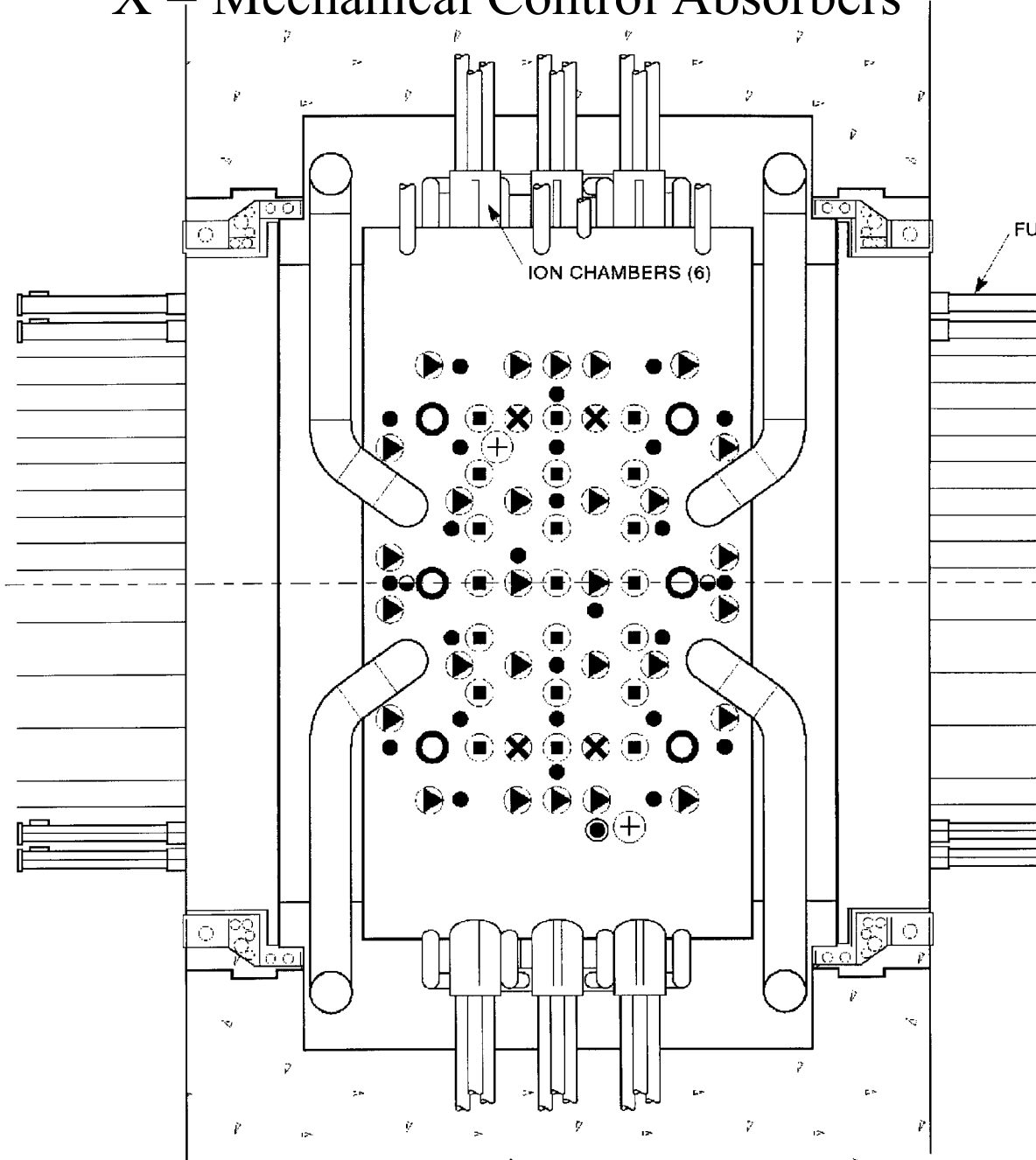



Adjuster Rods

- When refuelling unavailable (fuelling machine “down”) for long period, or for xenon override:
- **21 adjuster rods**, made of stainless steel or cobalt (to produce ^{60}Co for medical applications).
- Adjusters are normally in-core, and are driven out (vertically) when extra positive reactivity is required.
- The reactivity worth of the complete system is about 15 mk.
- Maximum rate of change of reactivity for 1 bank of adjusters is < 0.1 mk per second.
- The adjusters also help to **flatten** the power distribution, so that more total power can be produced without exceeding channel and bundle power limits.
- Some reactor designs (Bruce A) have no adjusters.

Top View Showing Adjuster Positions

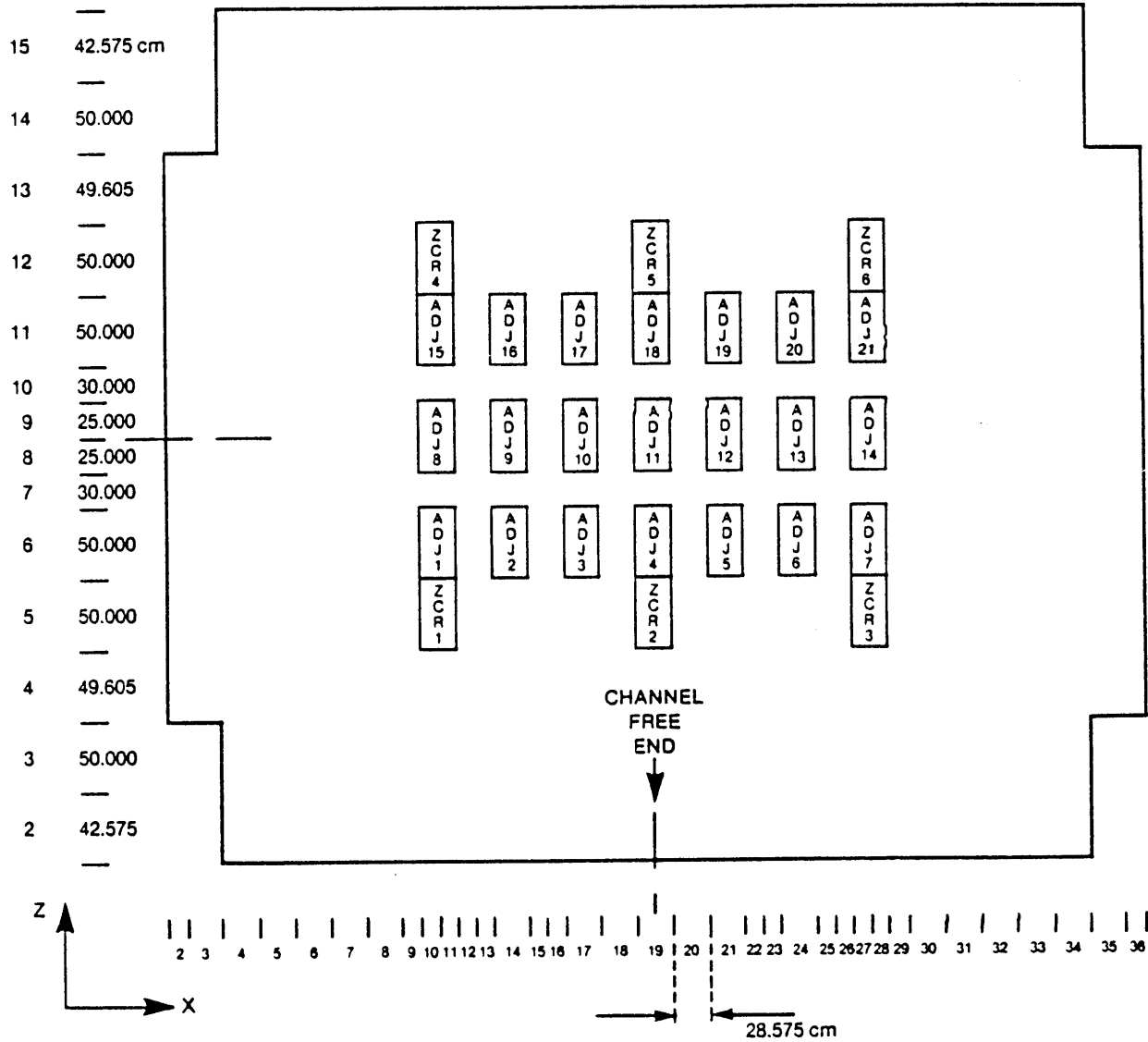

ADJ — ADJUSTER
ZCR — ZONE CONTROLLER

Face View Showing Adjuster Positions

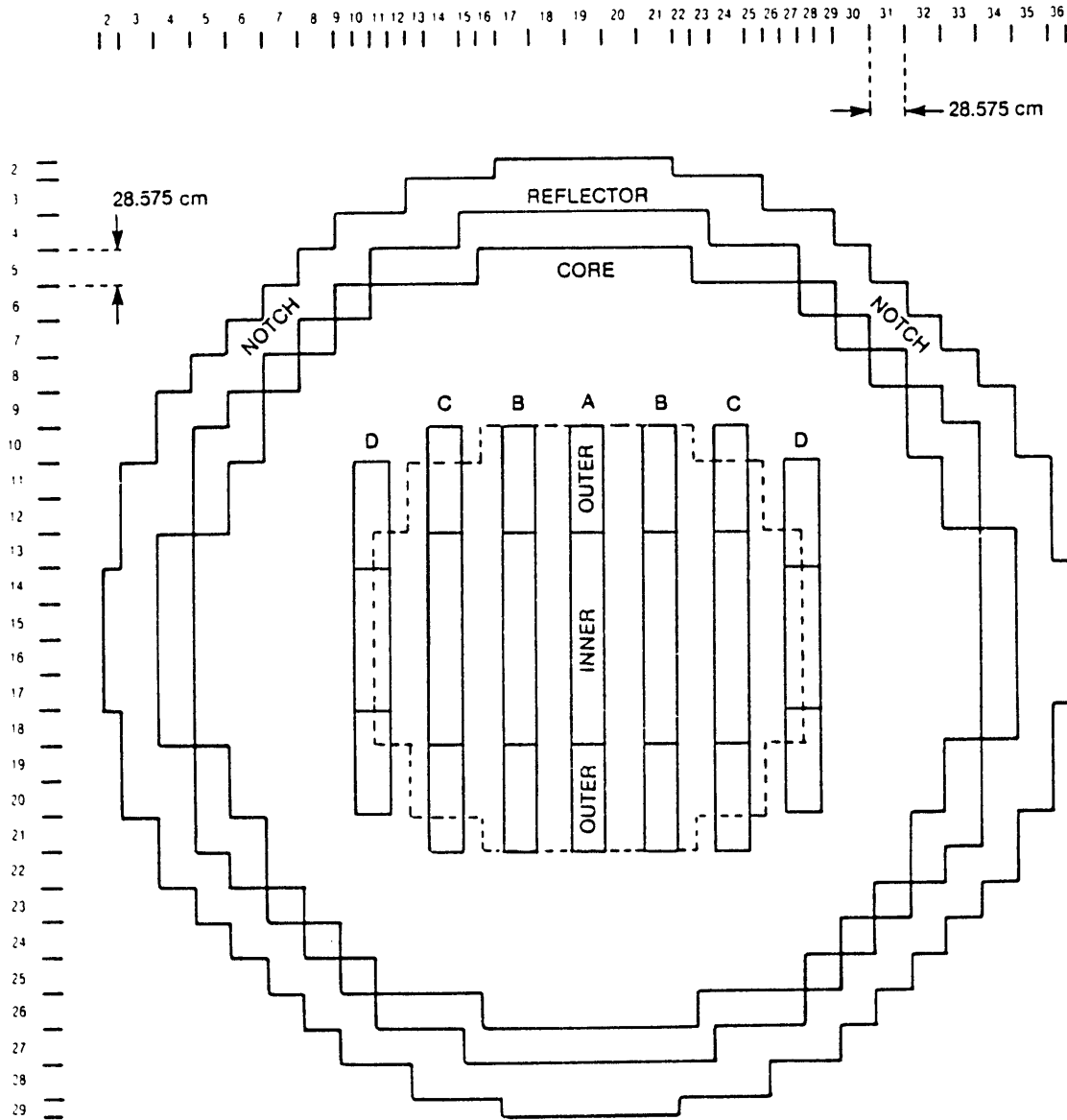

- - - - INNER CORE OUTER CORE BOUNDARY



Moderator Poison

- Moderator poison is used to compensate for excess reactivity:
 - in the initial core, when all fuel in the core is fresh, and
 - during and following reactor shutdown, when the ^{135}Xe concentration has decayed below normal levels.
- Boron is used in the initial core, and gadolinium is used following reactor shutdown. Advantage of gadolinium is that burnout rate compensates for xenon growth.



SDS-1

- **SDS-1: 28 shutoff rods, tubes consisting of cadmium sheet sandwiched between two concentric steel cylinders.**
- **The SORs are inserted vertically into perforated circular guide tubes which are permanently fixed in the core.**
- **See locations in next Figure.**
- **The diameter of the SORs is about 113 mm.**
- **The outermost four SORs are ~4.4 m long, the rest ~5.4 m long.**
- **SORs normally parked fully outside core, held in position by an electromagnetic clutch. When a signal for shutdown is received, the clutch releases and the rods fall by gravity into the core, with an initial spring assist.**

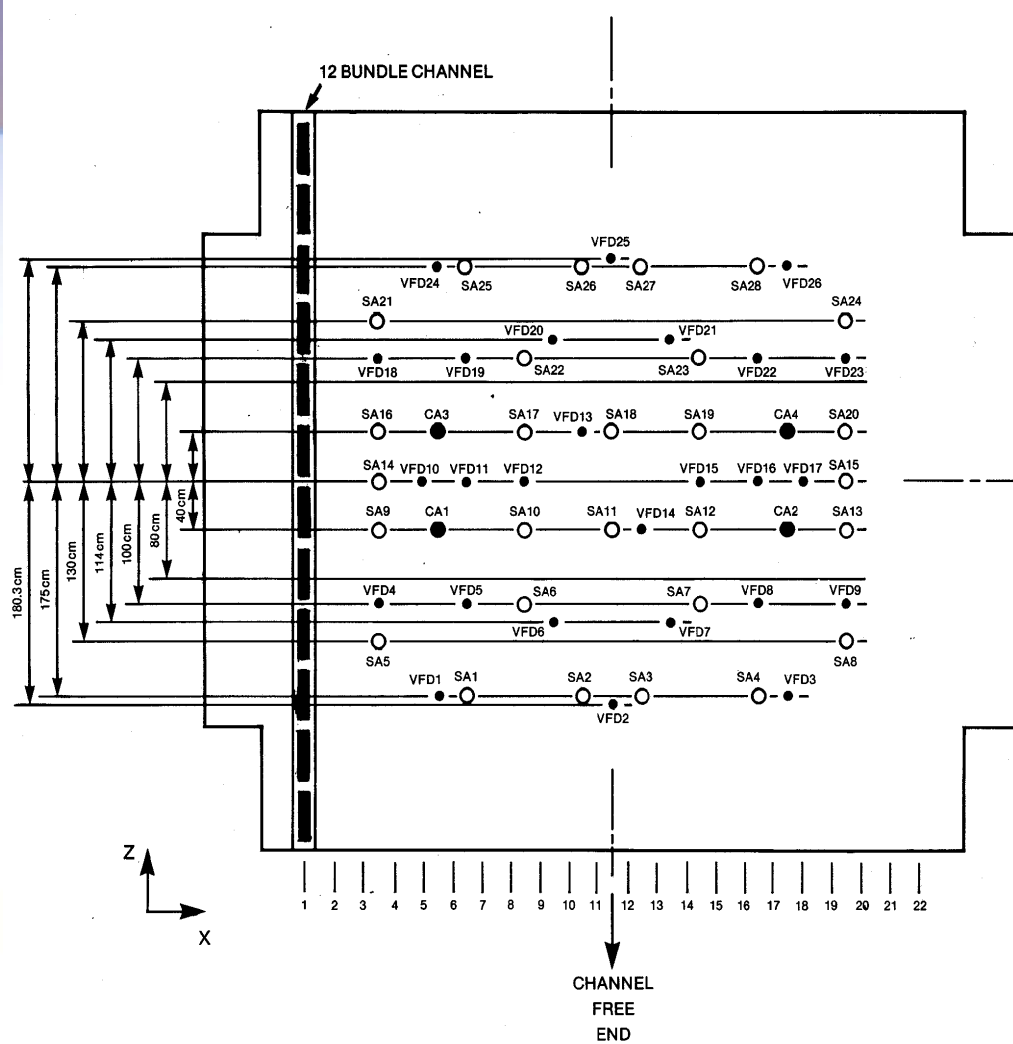

LEGEND

- VFD — VERTICAL FLUX DETECTOR ASSEMBLIES
- SA — SHUTOFF ROD GUIDE TUBES
- CA — CONTROL ABSORBER GUIDE TUBES

Top View Showing Shutoff-Rod Positions



SDS-2

- **SDS-2: high-pressure injection of solution of gadolinium into the moderator in the calandria.**
- **Gadolinium solution normally held at high pressure in vessels outside of the calandria. Concentration is ~8000 g of gadolinium per Mg of heavy water.**
- **Injection accomplished by opening high-speed valves which are normally closed.**
- **When the valves open, the poison is injected into the moderator through 6 horizontally oriented nozzles that span the core (see next Figure).**
- **Nozzles inject poison in four different directions in the form of a large number of individual jets.**
- **Poison disperses rapidly throughout large fraction of core.**

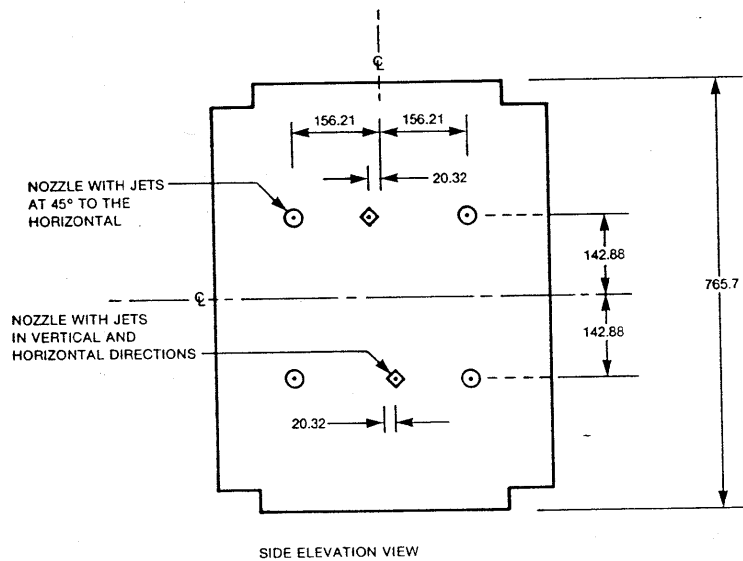
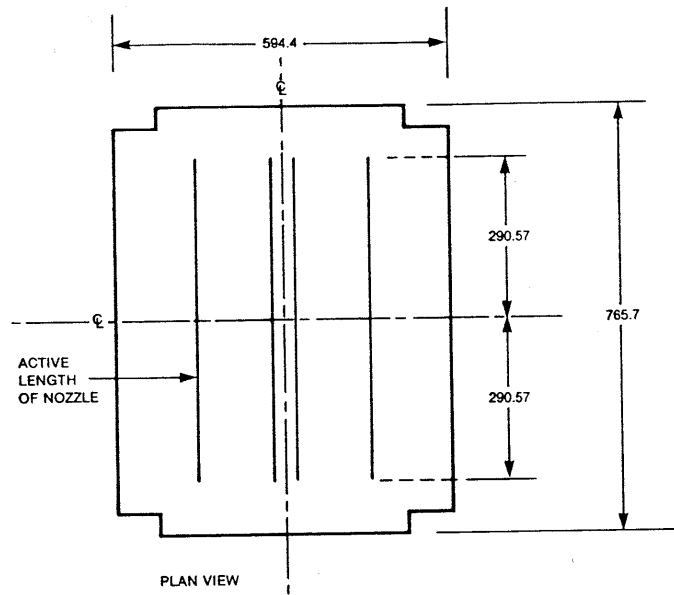



Detector Systems: Zone-Control Detectors

- **1 fast-response detector per zone compartment (+1 spare)**
- **Bulk control: average of the 14 detector readings used as indicator of current power. Water fills in all compartments uniformly increased or decreased to move reactor power down or up to the desired power. Bulk control exercised automatically by the RRS every half second.**
- **Spatial control: individual detector readings used as indicator of zone powers. Water fills in compartments manipulated differentially to shape 3-d power distribution to target shape. Spatial control exercised automatically by the RRS every half second.**
- **Detectors give essentially “point” readings; are calibrated every 2 minutes to zone fluxes from flux-mapping system.**

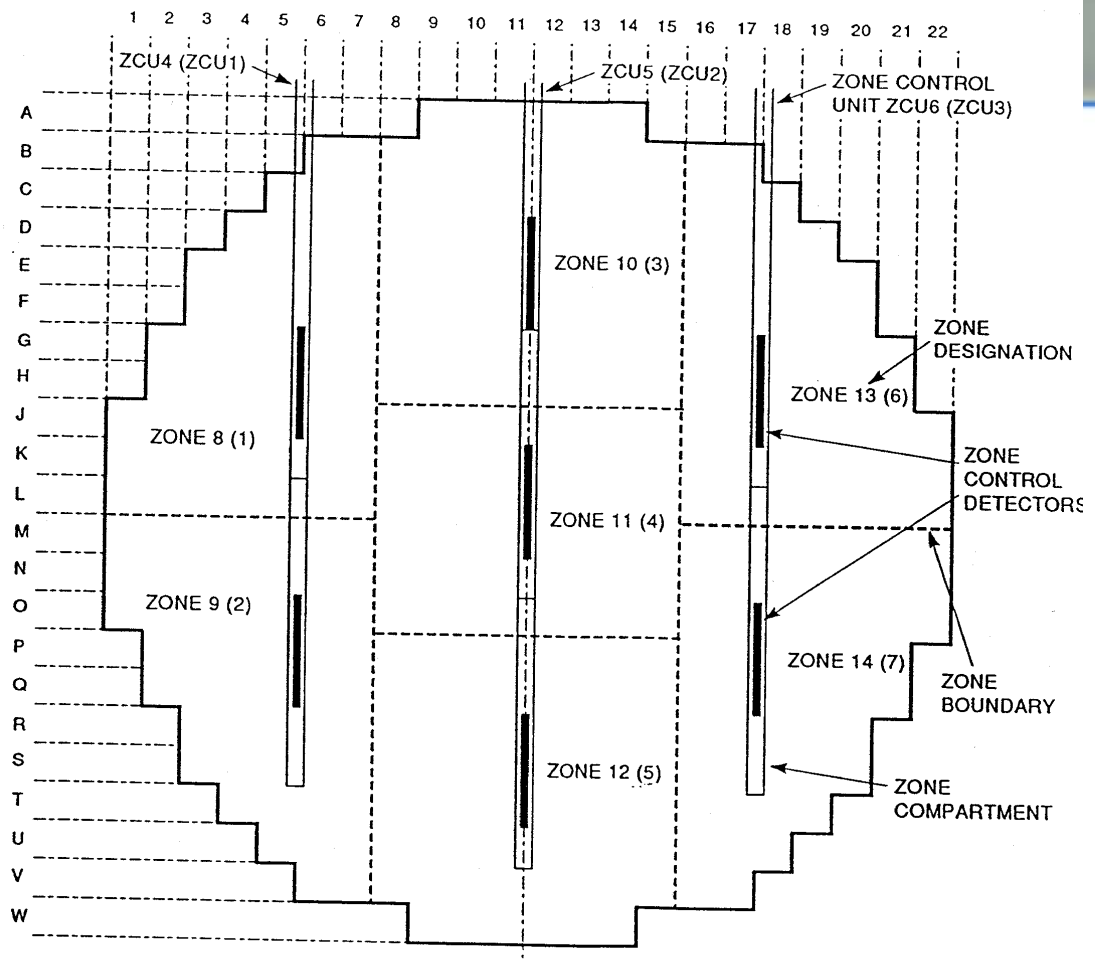

NOTES:

- 1 FACE VIEW FROM PRESSURIZER END. ZONES AND ZONE CONTROLLERS AT OTHER END (AWAY FROM PRESSURIZER) ARE GIVEN IN BRACKETS.
- 2 ZONE CONTROL DETECTORS ARE 3 LATTICE PITCHES LONG AND LOCATED IN VFDA's 1, 2, 3 AND 24, 25, 26 AXIALLY OUTBOARD FROM THE ZCUs.

920001

Positions of Zone-Control Detectors (Note: Detectors are not inside Compartments)



Neutronic Protection Systems

- **CANDU reactors are equipped with protection systems which detect an emergency situation and actuate the safety system(s).**
- **There is a separate neutronic protection system for each SDS.**
- **Each protection system is triplicated [has 3 separate “logic” (or “safety”) channels] and consists of out-of-core ion chambers and in-core self-powered detectors.**
- **Logic channels are D, E, and F for SDS-1 and G, H, and J for SDS-2.**
- **In each protection system, it suffices that 2 of 3 logic channels be “tripped” for the corresponding SDS to be actuated.**



Out-of-Core Ion Chambers

- There are 3 ion chambers in each protection system, 1 per logic channel.
- They are located at the outside surface of the calandria (see next Figure).
- Each ion chamber trips its logic channel when the measured rate of change of the logarithm of the flux ϕ , i.e. the quantity $d(\ln \phi)/dt$, exceeds a pre-determined setpoint (e.g. 10% per second, i.e., 0.10 s^{-1} , for SDS-1 in the CANDU 6).

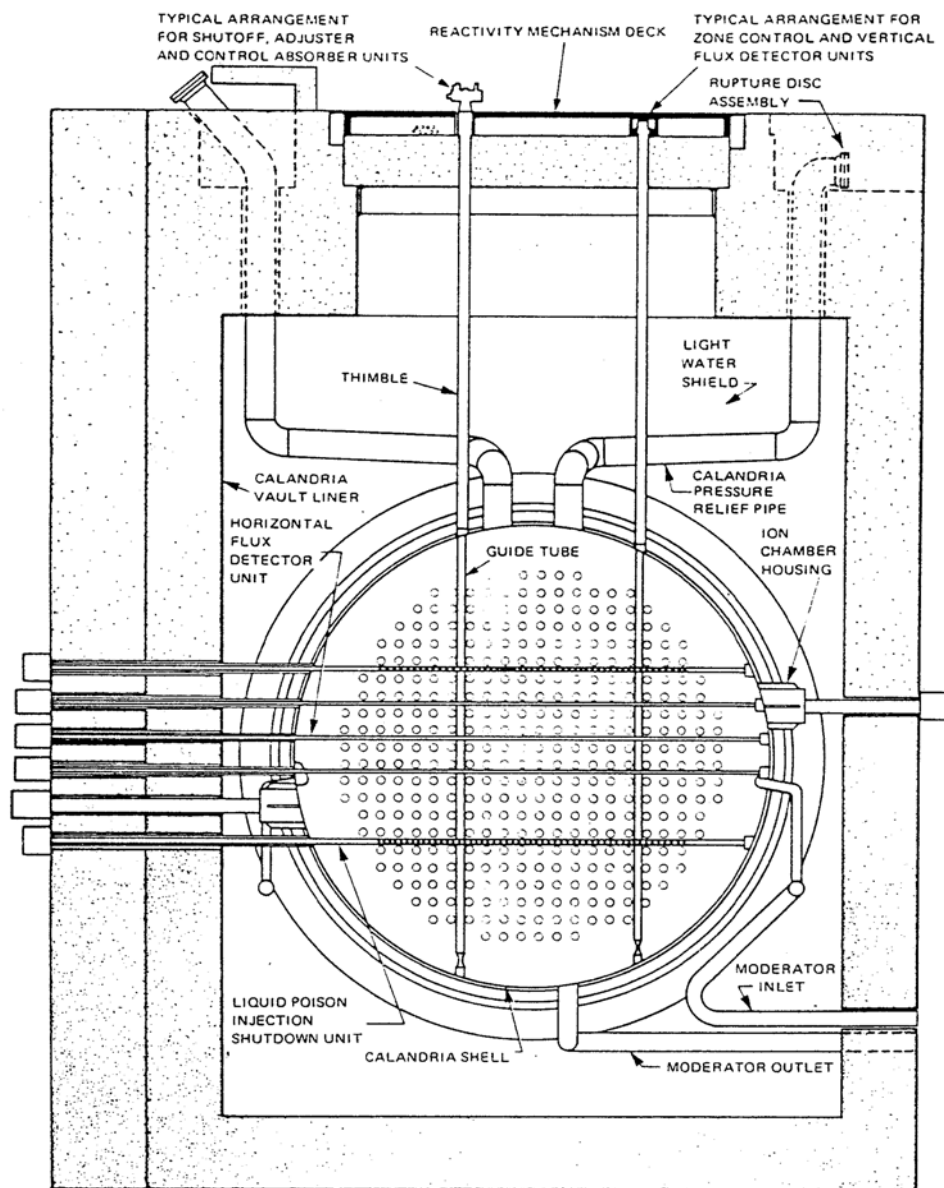

Ion-Chamber Locations



In-Core ROP Detectors

- **There are also fast-response (platinum or inconel) in-core detectors in each protection system.**
- **34 in-core detectors for SDS-1, in vertical assemblies, and 24 for SDS-2, in horizontal assemblies (see next 2 Figures).**
- **The detectors are distributed among the various logic channels: channels D, E and F contain 11 or 12 detectors each, channels G, H, and J contain eight each.**
- **The detectors trip the logic channels on high neutron flux: when the reading of any 1 detector reaches a pre-determined setpoint, the logic channel to which it is connected is tripped.**
- **The in-core-detector system is known as the regional-overpower-protection (ROP) system.**
- **The detector trip setpoints are determined by an extensive analysis of hypothetical loss-of-regulation accidents.**

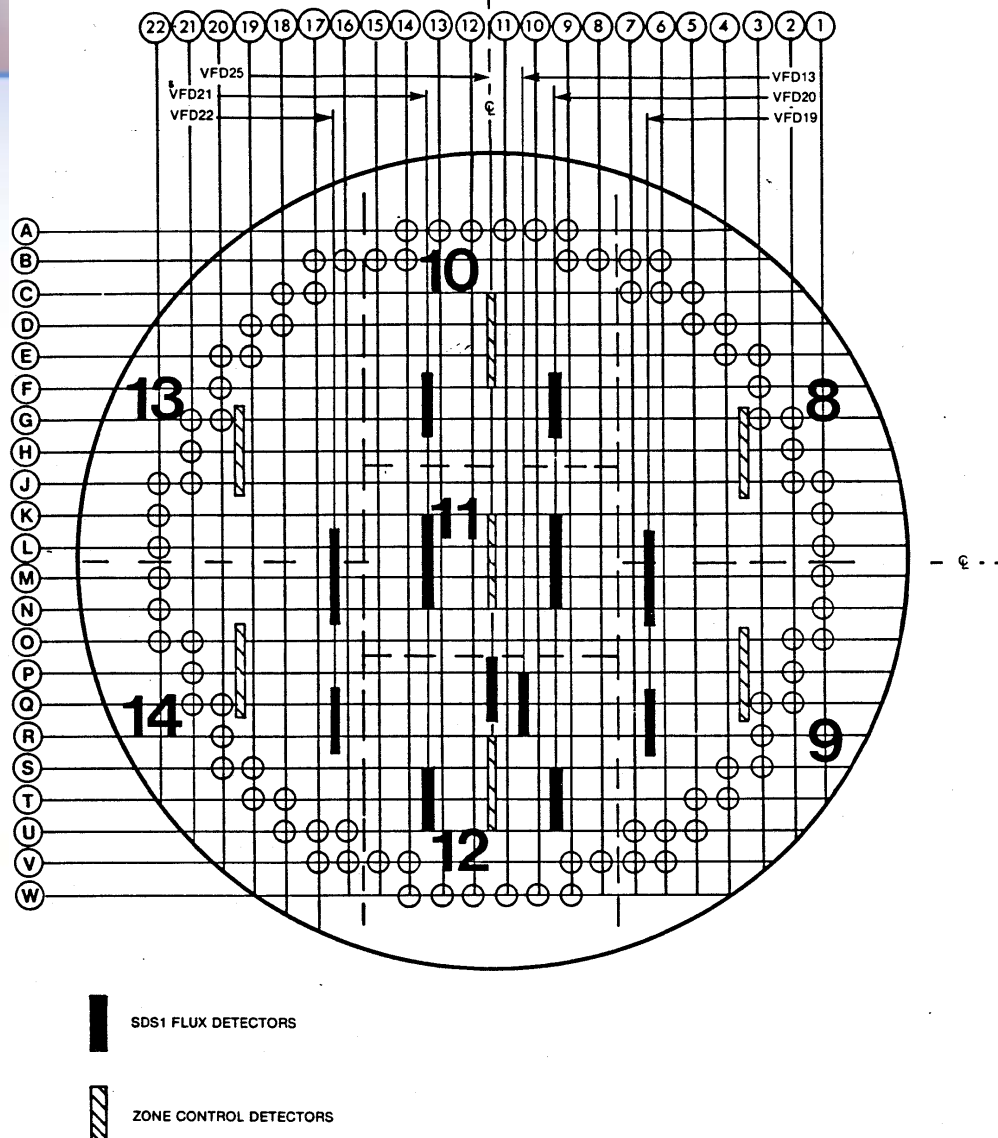

3.3
 FIGURE 3-13-2 (continued) — VIEW 3

SDS1 In-Core-Detector Locations



LEGEND:
CHANNEL SYMBOL

G

H

J

ZONE CONTROL
DETECTORS

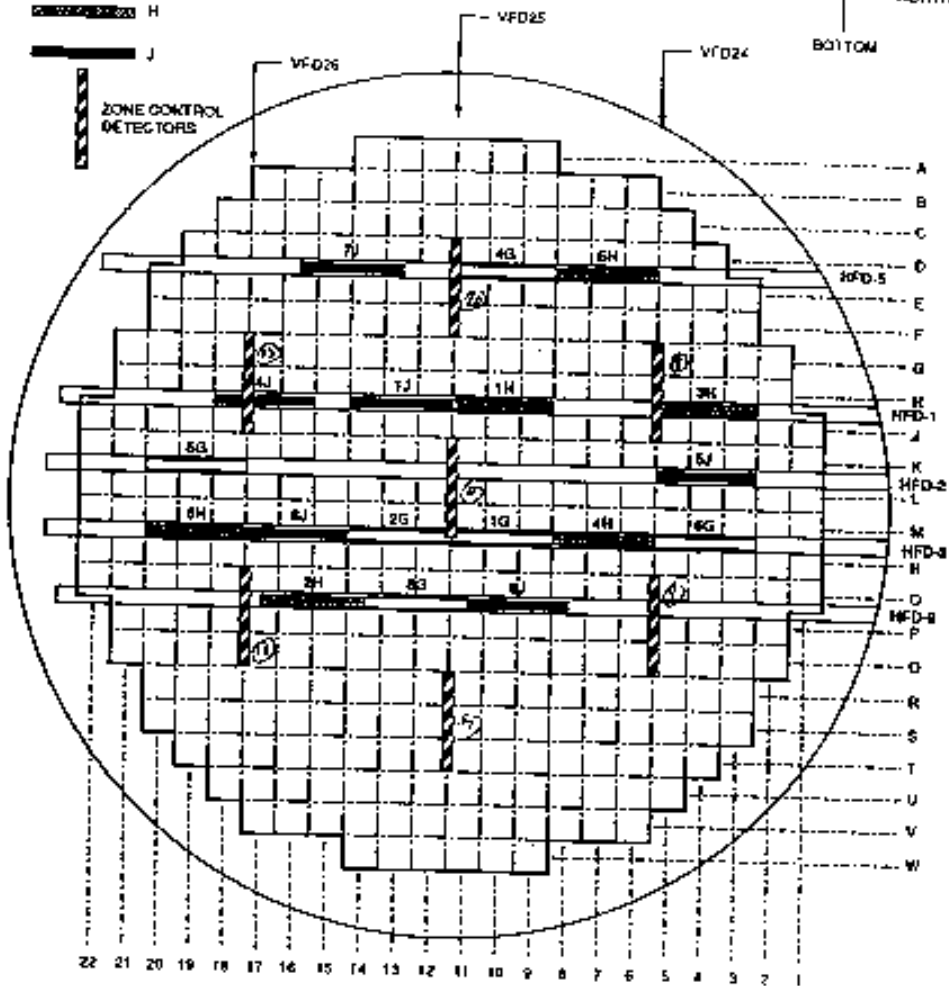
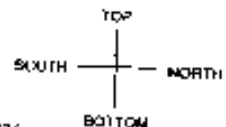

22047

DETECTOR 2H DIFFERENCED WITH 5H
DETECTOR 8G DIFFERENCED WITH 4G
DETECTOR 8J DIFFERENCED WITH 7J

SDS2 In-Core-Detector Locations



Triplicated Tripping Logic

- **The tripping logic of each triplicated protection system is as follows (see next Figure):**
- **One ion chamber can trip its logic channel on high log rate, or any 1 detector in the logic channel can trip the channel on high flux.**
- **Any 2 tripped channels will actuate the associated shutdown system.**
- **The triplicated tripping logic reduces the chance of a spurious trip, and allows the testing of the system on-line.**

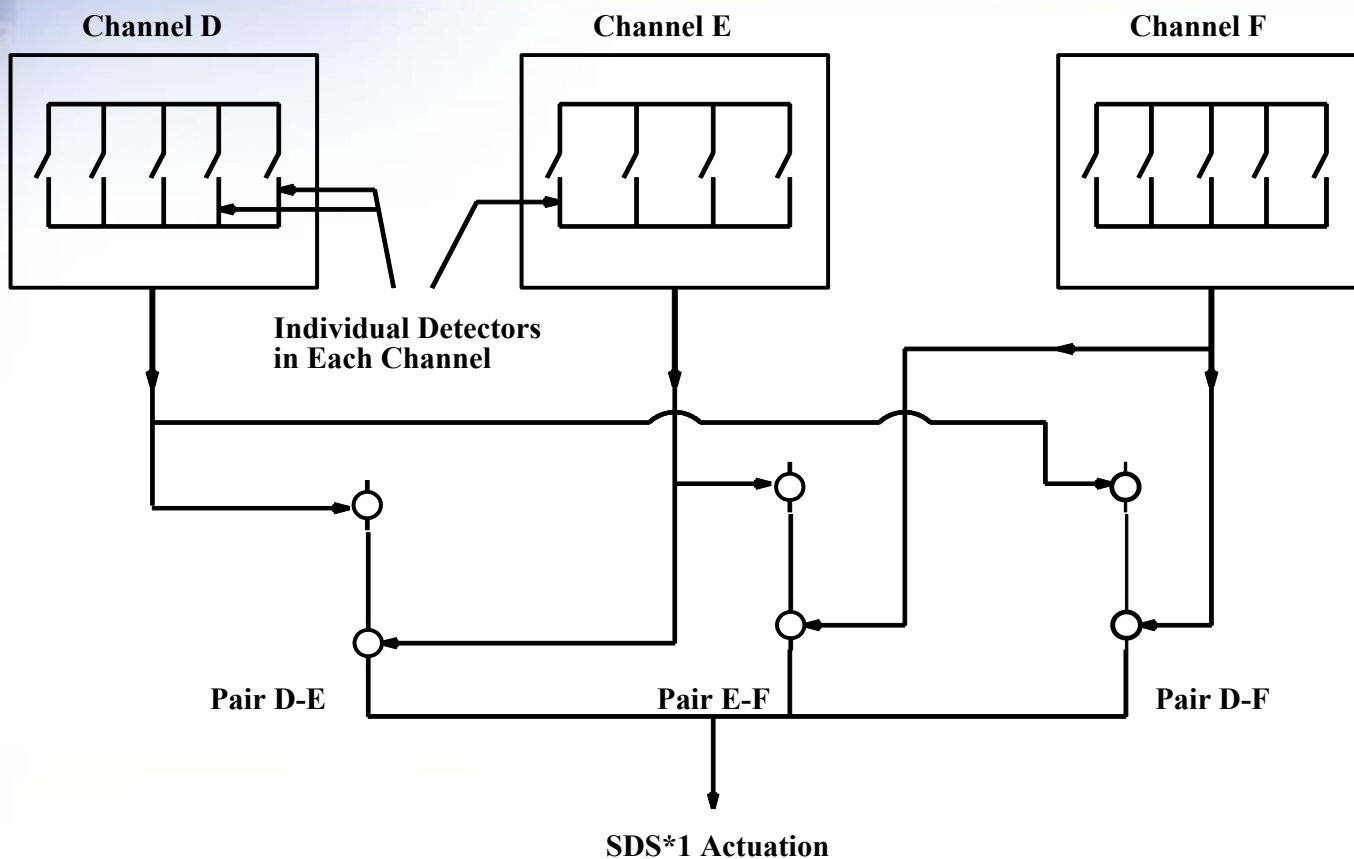

Triplicated Tripping Logic for SDS-1



Flux-Mapping System

- The CANDU 6 is provided with a flux-mapping system to synthesize the 3-dimensional flux distribution in the reactor from in-core detector readings.
- The system consists of 102 vanadium detectors (1 Ip long) at various positions in the core (see next Figure).
- The flux-mapping procedure consists of assuming the 3-d flux distribution can be written as a linear combination of a number of basis functions or flux modes.
- The mode amplitudes are determined by a least-squares fit of the calculated fluxes at the 102 detectors to the measured fluxes. The 3-d flux distribution can then be reconstructed.
- The flux-mapping modes consist 15 pre-calculated harmonics of the neutron diffusion equation (see following Figure) and some reactivity-device modes.
- Flu mapping is done automatically every 2 minutes.

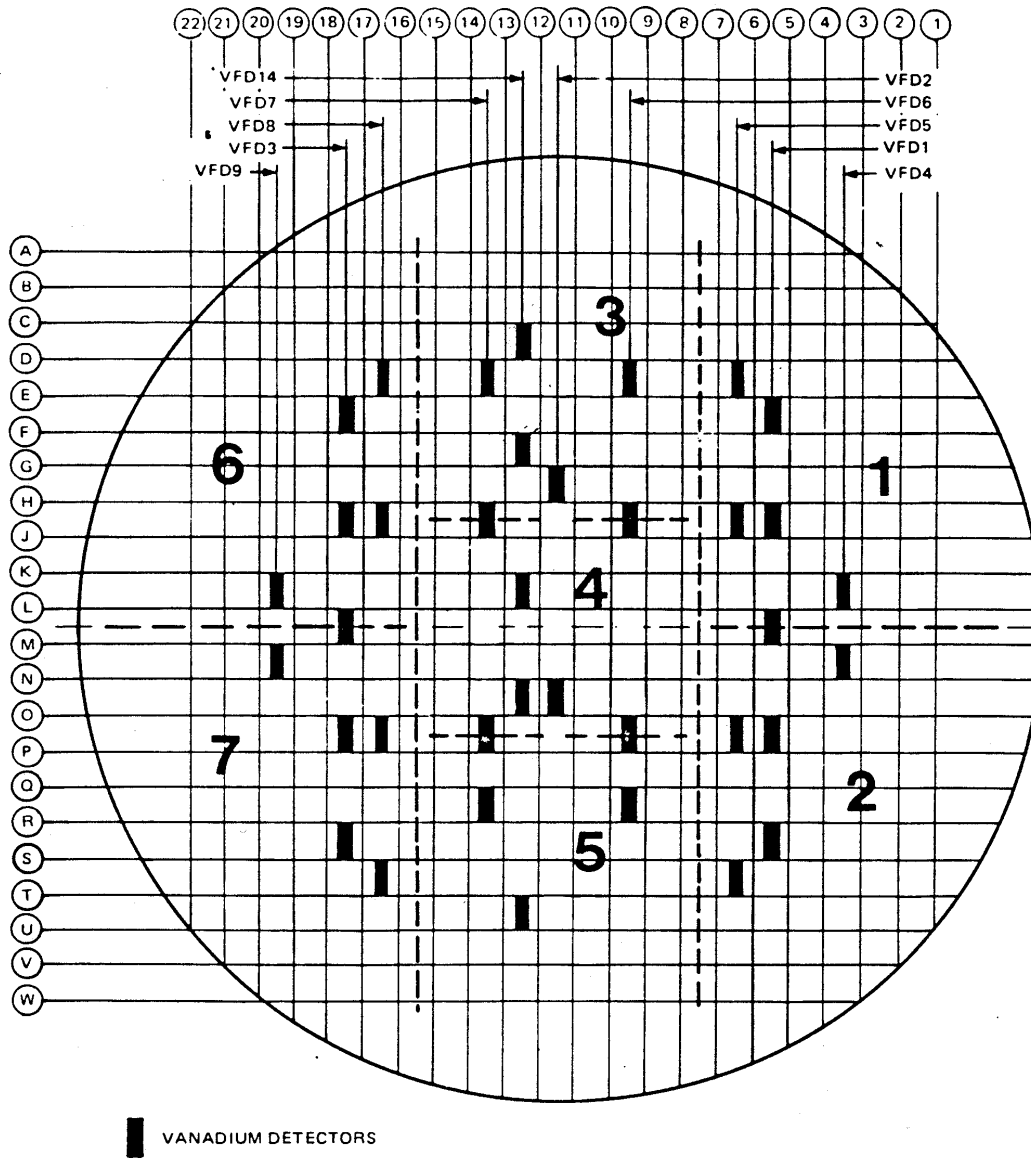

Flux-Mapping Detectors



MODE NUMBER	DESIGNATION	SUBCRITICALITY MK	MODE SCHEMATIC (IDEALIZED)
0	Fundamental	0	
1	First Azimuthal-A	16.2	
2	First Azimuthal-B	16.9	
3	First Axial	27.1	
4	Second Azimuthal-A	44.0	
5	Second Azimuthal-B	47.0	
6	First Azimuthal-A x First Axial	46.9	
7	First Azimuthal-B x First Axial	47.7	
8	First Radial x Second Axial-A	66.3	
9	First Radial x Second Axial-B	80.6	

Harmonic Modes for Flux-Mapping



Computational Scheme for CANDU Neutronics

- The basic aim of reactor-physics calculations is to calculate the neutronics of the core, i.e., the distribution of neutron flux and various reaction rates in the reactor, and, most importantly, the power distribution, as a function of space and time.
- The computational scheme for CANDU neutronics consists of three stages. Computer programs have been developed to perform the calculations corresponding to each stage.



Cell Calculation

- **First stage: calculating lattice properties for basic lattice cells. The older lattice code POWDERPUFS-V has been replaced by the Industry Standard Tool WIMS-IST, a 2-d-transport-theory code.**
- **In cell code, detailed calculation of nuclear properties is made for a basic lattice cell. Idea is to calculate “homogenized-cell” lattice properties (nuclear cross sections), averaged over the cell [to be used in finite-reactor model to calculate the power distribution in core]**
- **Lattice calculations are done assuming “mirror” (reflective) properties at the cell boundaries. This is equivalent to doing calculations for an infinite lattice of identical cells.**

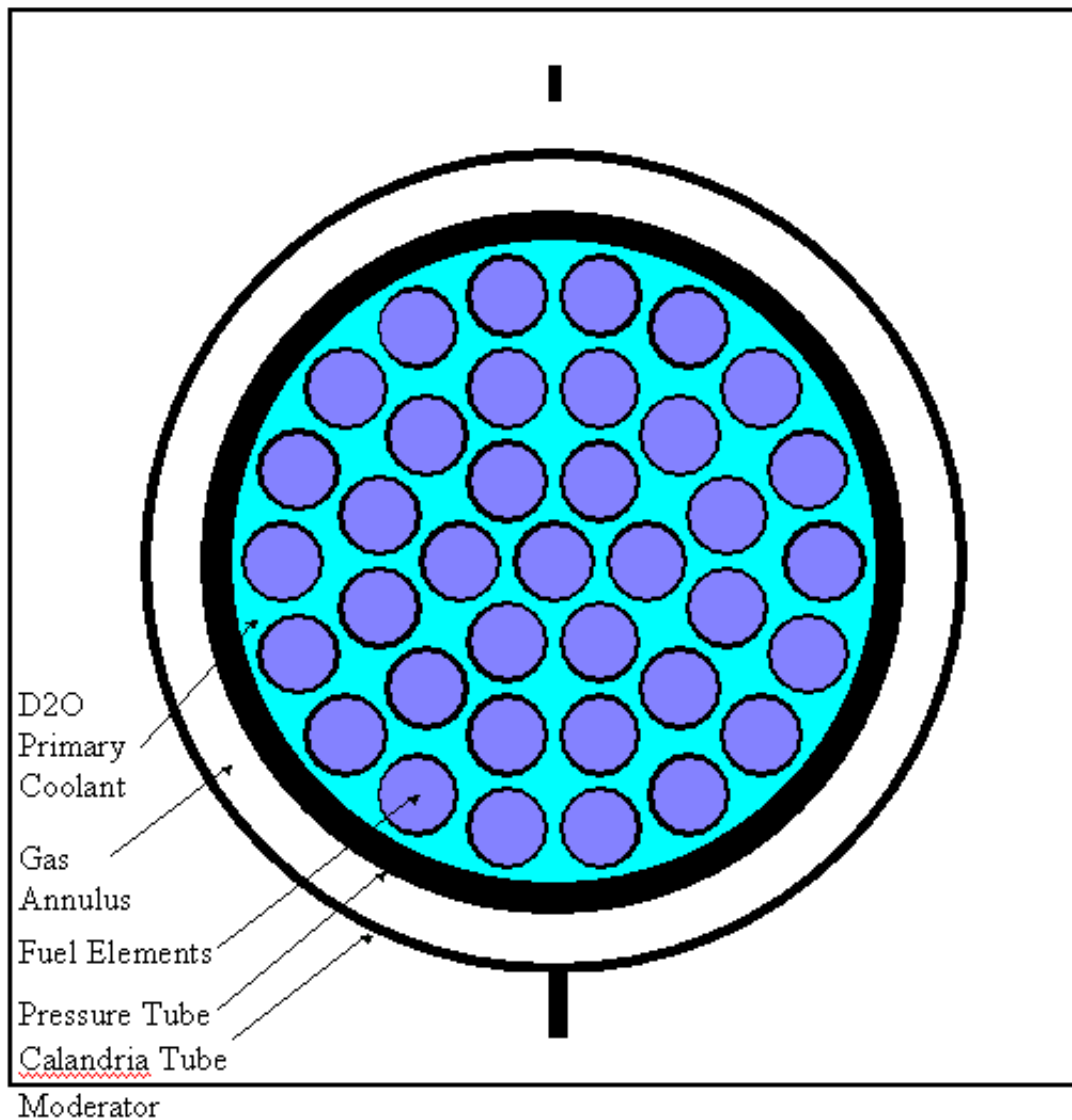

Face View of CANDU Basic-Lattice Cell



Cell Calculation

- **Because the neutron spectrum (energy distribution) is very well thermalized in the CANDU heavy-water moderator (~95% of neutrons in the moderator are thermal), two neutron energy groups - thermal and “fast” (or “slowing down”) - are certainly sufficient for the homogenized properties.**



Cell Calculation

- **The cell code must be able to derive these lattice properties as a function of fuel irradiation (or burnup) and for different types of conditions in the cell, such as:**
- **various fuel-bundle designs (28-el, 37-el, CANFLEX, ...)**
- **different fuel, coolant, and/or moderator temperatures**
- **varying coolant density**
- **different levels of fuel power**
- **various concentrations of moderator poison**
- **etc.**



Supercell Calculation

- Various reactivity devices perturb the basic-lattice properties in their vicinity.
- The aim of “supercell” calculations is to determine “incremental” cross sections (e.g., incremental absorption cross sections Σ_{a1} , Σ_{a2}), to be added to the basic-cell properties in cells which contain reactivity devices, to account for the effect of the devices.
- The incremental cross sections are obtained by calculating homogenized properties in a “supercell” (see next Figure) with and then without the device, and then subtracting.
- The old supercell code was MULTICELL, now replaced by DRAGON-IST, a 3-d-transport-theory code.

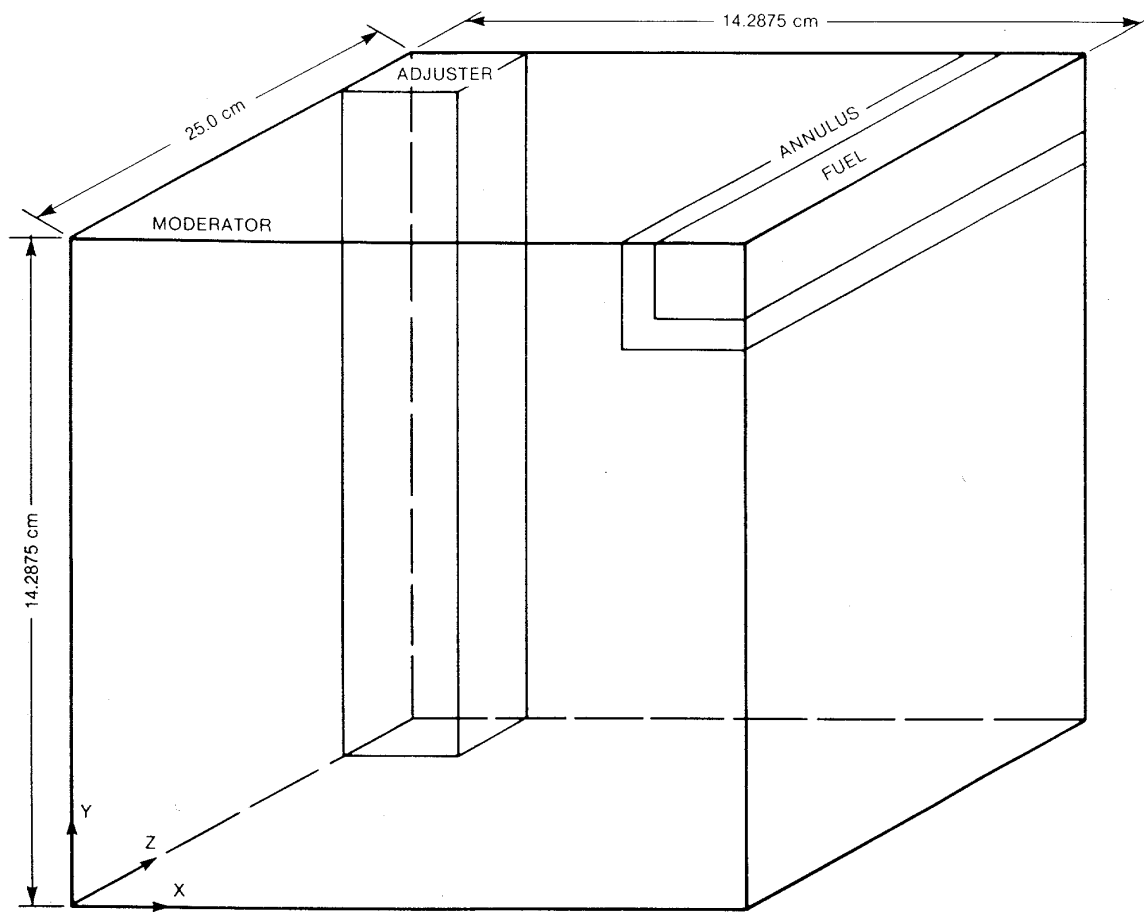

Typical CANDU Supercell Model



Finite-Core Calculation and the RFSP-IST Code

- **Once basic-lattice properties and reactivity-device incremental cross sections are available, the finite-core calculation can proceed.**
- **The Industry Standard Tool for finite-core calculations is RFSP-IST (Reactor Fuelling Simulation Program), which was specifically designed for CANDU reactors.**
- **It can calculate the steady-state 3-dimensional flux and power distributions in the reactor using two different methods:**
 - **by solving the time-independent finite-difference diffusion equation in two energy groups, and**
 - **by the method of flux mapping , if the readings of the in-core vanadium detectors are available.**



Finite-Core Calculation and the RFSP-IST Code

- RFSP-IST solves the 2-energy-group diffusion equation below
- [In the POWDERPUFS-V methodology, there are no fast-fission or up-scattering terms]

$$-\vec{\nabla} \cdot D_1(\vec{r}) \vec{\nabla} \phi_1(\vec{r}) + (\Sigma_{a1}(\vec{r}) + \Sigma_{1 \rightarrow 2}(\vec{r})) \phi_1(\vec{r}) - \left(\Sigma_{2 \rightarrow 1}(\vec{r}) + \frac{\nu \Sigma_{f2}(\vec{r})}{k_{eff}} \right) \phi_2(\vec{r}) = 0$$

$$-\vec{\nabla} \cdot D_2(\vec{r}) \vec{\nabla} \phi_2(\vec{r}) + (\Sigma_{a2}(\vec{r}) + \Sigma_{2 \rightarrow 1}(\vec{r})) \phi_2(\vec{r}) - \left(\Sigma_{1 \rightarrow 2}(\vec{r}) + \frac{\nu \Sigma_{f1}(\vec{r})}{k_{eff}} \right) \phi_1(\vec{r}) = 0$$



Time-Independent Equation = Eigenvalue Problem

- This time-independent equation is an eigenvalue problem because a steady-state (critical) reactor configuration does not have a solution for just **any** given combination of properties.
- The unknowns (the flux values at each mesh point) typically number in the several tens of thousands.
- The k_{eff} is an adjustment factor, only certain values of which result in a steady state - the largest is the reactor multiplication constant and is a measure of how far from criticality the given reactor configuration is.
- A typical reactor model used with RFSP-IST is shown in the next 2 Figures (face and top views).

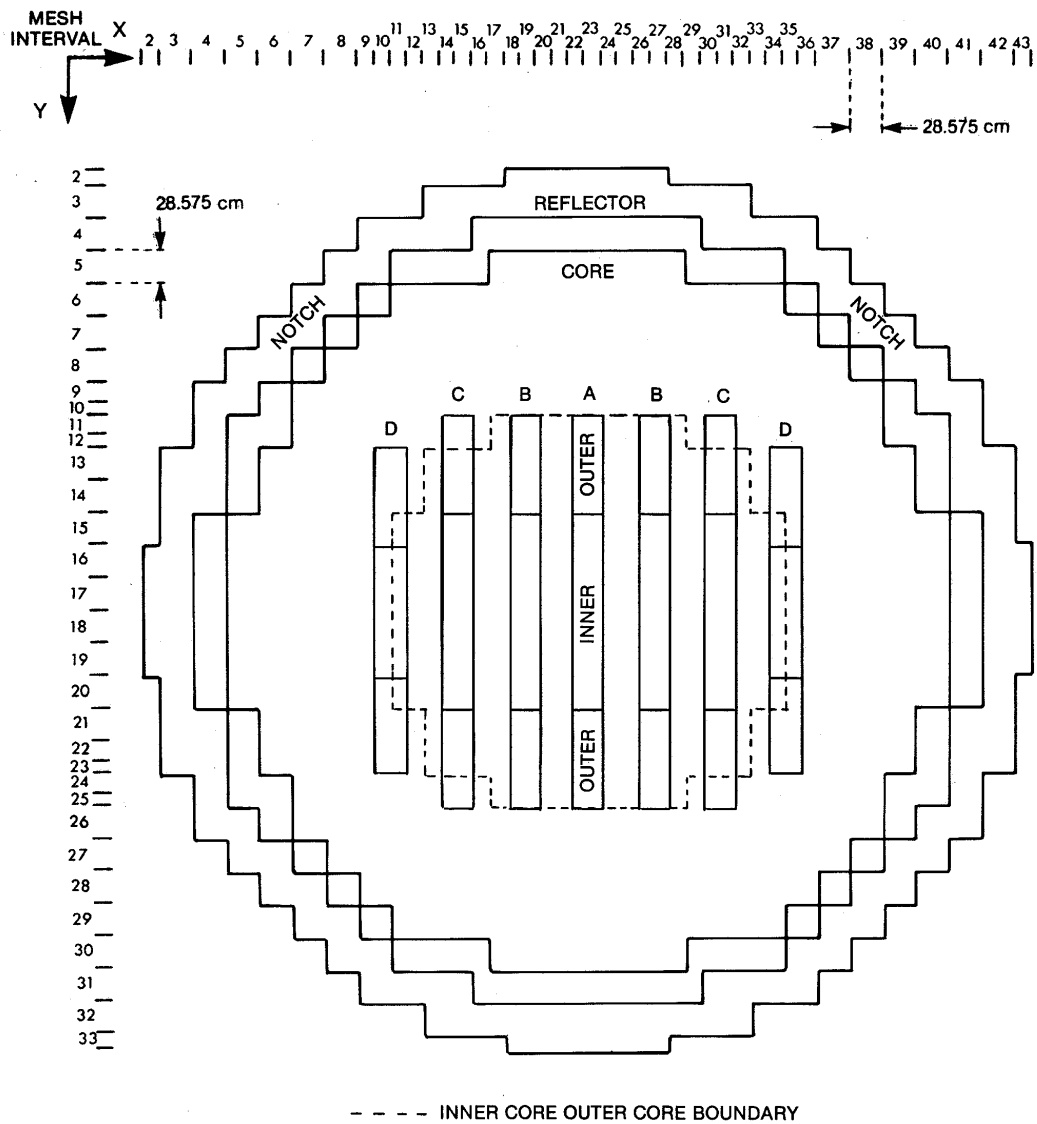

Typical RFSP-IST Reactor Model (Face View) Pg 125

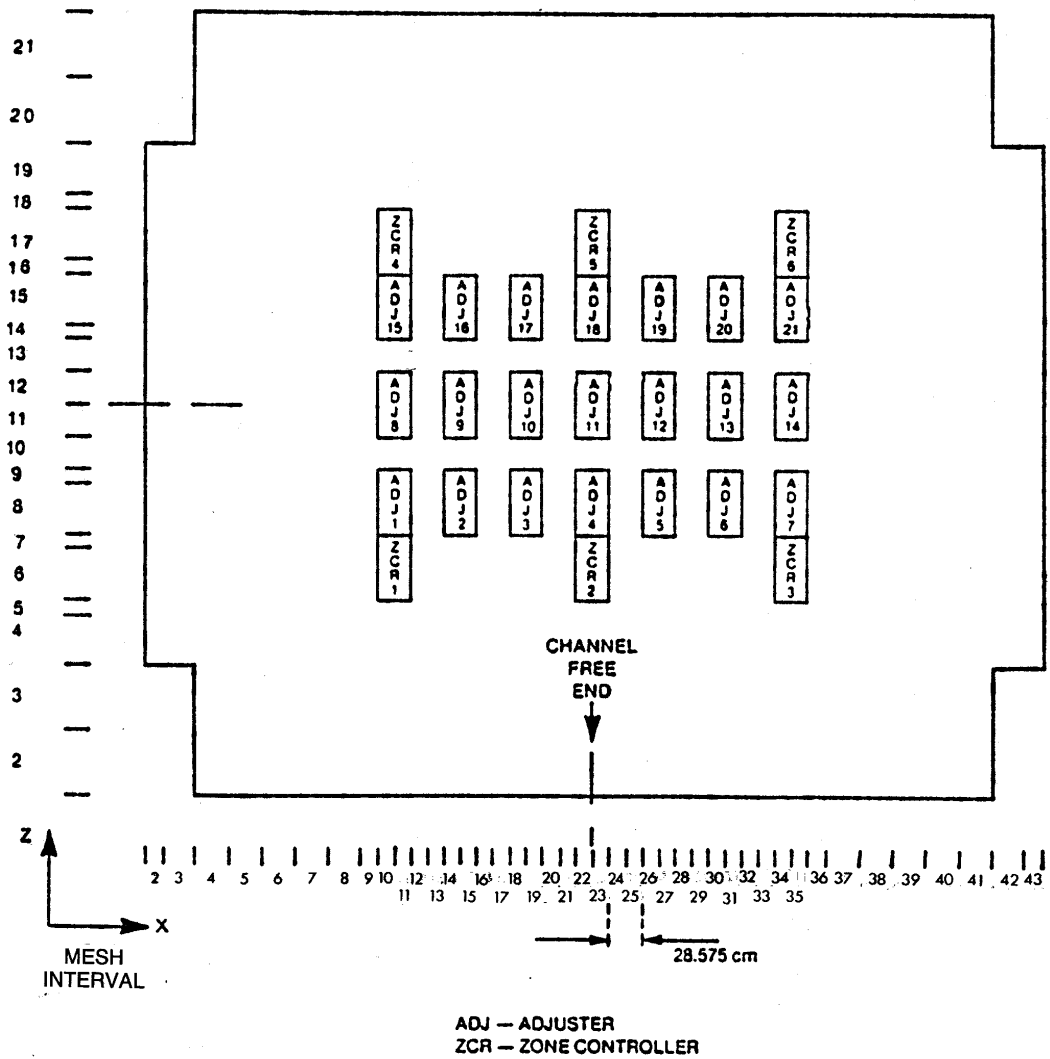

Typical RFSP-IST Reactor Model (Top View)



Finite-Core Calculation and the RFSP Code

- Major applications of RFSP are in:
- core-design calculations and analyses, including fuel-management design calculations, and simulations of reactor power histories
- core-follow calculations at CANDU sites, to track the actual reactor operating history, with burnup steps and channel refuellings.



Capabilities of RFSP-IST

Additional capabilities of the program include, among others:

- calculation of flux distributions for various reactor configurations**
- simulation of $^{135}\text{Xe}/^{135}\text{I}$ transients**
- simulation (quasi-statically) of bulk control and spatial control**
- calculation of harmonic flux shapes for use in flux mapping**
- calculation of reactivity increase expected on refuelling of individual fuel channels**
- capability for solving neutron-kinetics problems by the Improved Quasi-Static (IQS) method.**
- RFSP can therefore be used to analyze fast transients, such as those following hypothetical large-loss-of-coolant accidents (LOCA), and can be used to simulate and verify the performance of the shutdown systems.**



CANDU Positive Void Reactivity

- **Coolant voiding in CANDU introduces positive reactivity and promotes a power rise.**
- **Root cause: CANDU is a pressure-tube reactor, with coolant separate from moderator.**
- **In light-water reactors (LWR), one liquid serves as both coolant and moderator; loss of coolant is also loss of moderator, leading to less self-sustainable chain reaction, i.e., a decrease in reactivity.**
- **In CANDU, loss of coolant does not imply a significant reduction in moderation, but results in changes in neutron spectrum. These subtle changes in the spectrum result in the reactivity increase.**



CANDU Positive Void Reactivity

Simple explanation of major causes – 3 positive, 1 negative (refer to Figure of Basic Lattice Cell):

- When coolant is present, some fission neutrons are slowed down in the fuel cluster itself; when coolant is voided, fewer neutrons are slowed down in fuel cluster, allowing more fast neutrons to induce fast-group fission
- Also, since fewer neutrons are slowed down in fuel cluster to energies in the resonance range, more neutrons escape resonance absorption before entering moderator
- Most neutrons re-entering fuel cluster from moderator are thermal neutrons. Hot coolant promotes some to higher energies (by collision), leading to some resonance absorption. Without coolant, this effect is absent, and there is increased resonance absorption escape.

Cont'd



CANDU Positive Void Reactivity

Simple explanation of major causes – 3 positive, 1 negative (refer to Figure of Basic Lattice Cell):

- **For irradiated fuel, with plutonium, change in neutron spectrum gives also a negative component in reactivity change. This is due to a reduction in fissions from low-lying fission resonance (see following Figure). Net void reactivity is still positive (but smaller than for fresh fuel).**
- **Full-core void reactivity can range from 10 to 15 or more mk, depending on core burnup and other parameters. Of course, it is not physically possible to lose all coolant from the core instantaneously.**
- **However a Large Loss of Coolant is a hypothetical accident which must be analyzed.**

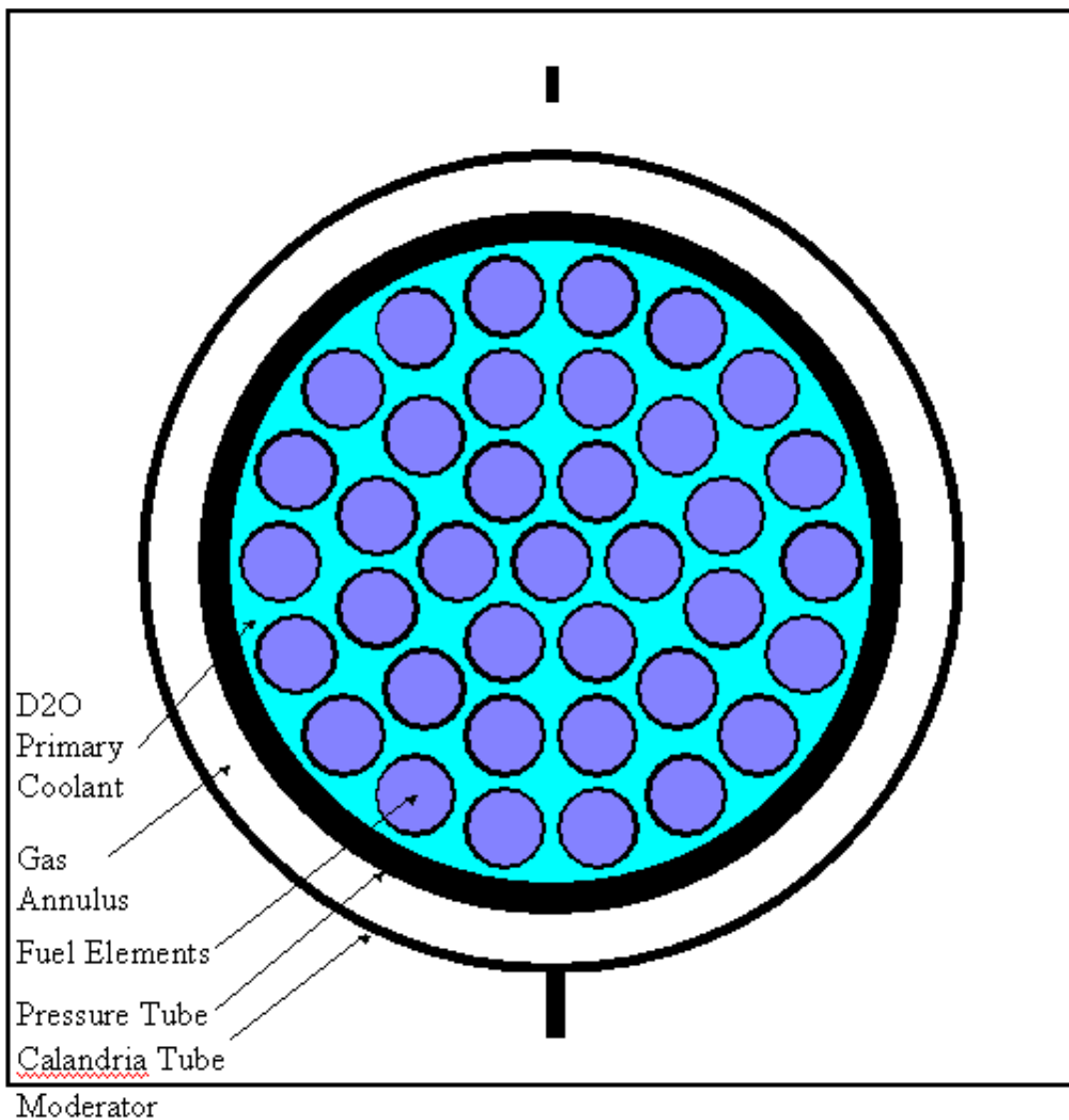

Face View of CANDU Basic-Lattice Cell

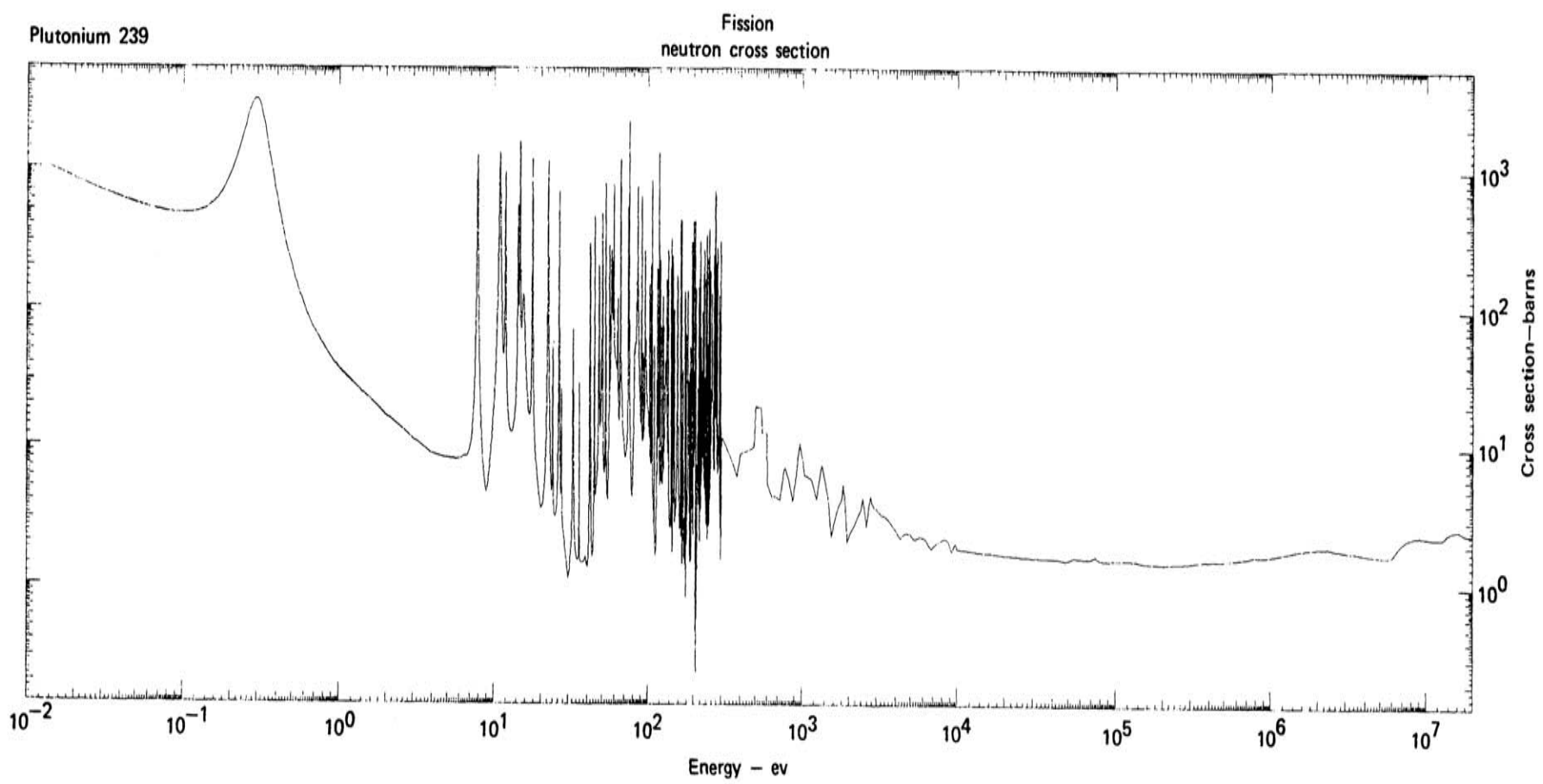

Low-Lying (0.3-eV) Fission Resonance in Plutonium-239



Large LOCA

- A large loss of coolant is the accident which presents the greatest challenge to CANDU shutdown systems in terms of rate of positive reactivity insertion.
- Large LOCA is caused by the rupture of a large pipe, e.g. RIH, ROH, or Pump-Suction pipe (see next Figure).
- In CANDU 6, a Large LOCA can inject 4-5 mk in the first second after the break, beyond capability of the Reactor Regulating System to control.
- This leads to a power pulse which must be terminated by a SDS.
- Manner in which shutdown systems act (separately) to terminate power excursion must be carefully studied. This is done with neutron kinetics codes. RFSP-IST itself has a kinetics capability.



Examples of Break Locations Giving Rise to a Large LOCA

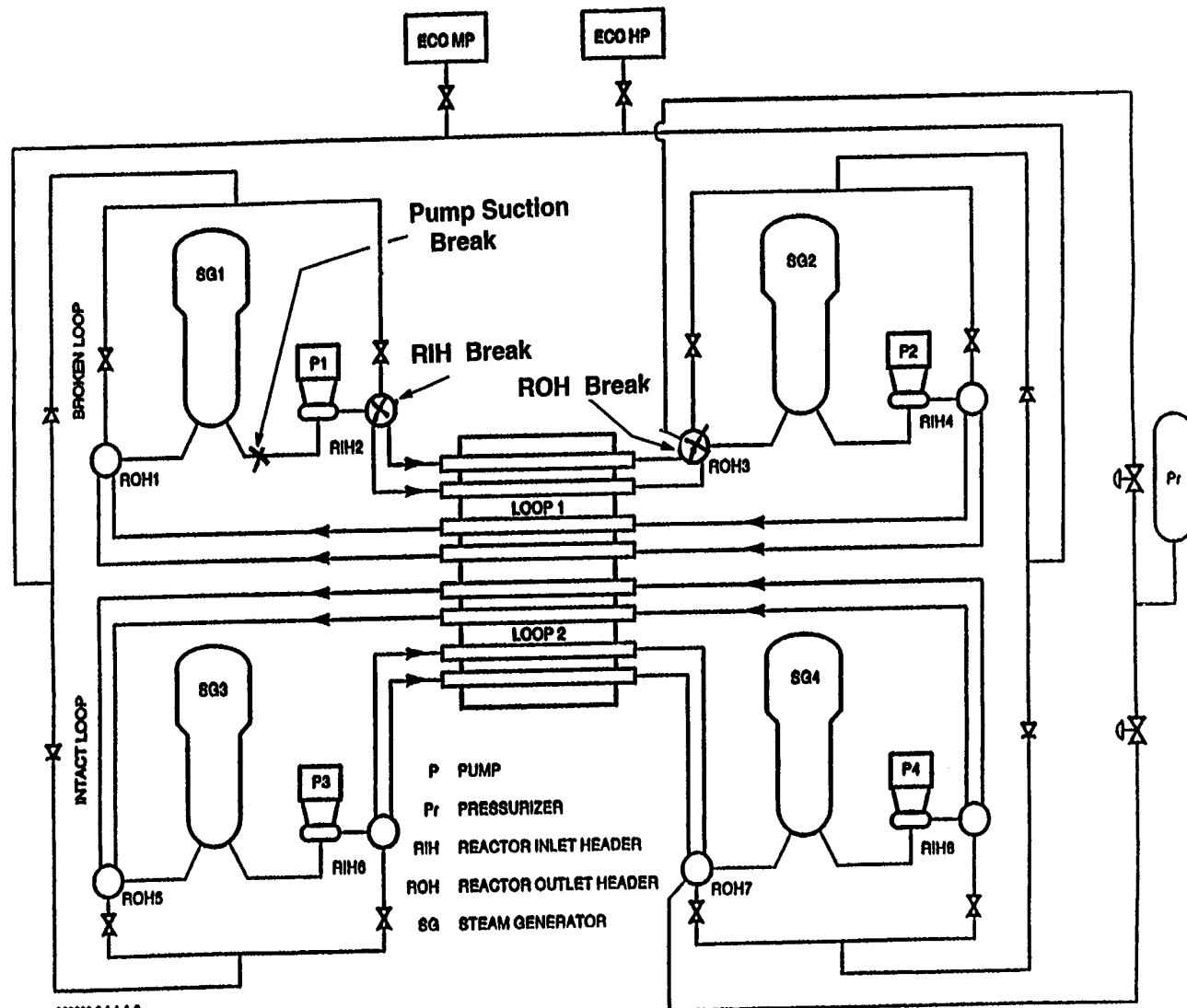

830063-2.1.1.A-2



Time-Average Model

- In the time-average model of the reactor, the lattice cross sections are averaged over the residence (dwell) time of the fuel at each point (fuel-bundle position) in the core.
- This allows the effect of the actual refuelling scheme used (e.g. 8-bundle shift, 4-bundle shift, etc.) to be captured.
- Calculations are performed in the *TIME-AVER module of RFSP-IST.
- Time-average nuclear cross sections are defined at each bundle position in core by averaging the lattice cross sections over the irradiation range “experienced” over time by fuel at that position, from the value of fuel irradiation when the fuel enters that position in core to the fuel irradiation when the fuel leaves that position.



Time-Average Model

- The time-average calculation is a self-consistency problem, because consistency must be achieved between the flux, the channel dwell times (interval between refuellings), the individual-bundle irradiation ranges, and the lattice properties. An iterative scheme of solution is employed until all quantities converge.
- Typically, in the time-average model, the core is subdivided into many irradiation regions.
- An average fuel exit irradiation is selected for each region, and the values are designed to achieve criticality and an acceptable degree of radial flattening of the flux shape.
- The exit irradiation values may have to be determined by several trials. Typical values are shown in the next Figure.
- The following Figure shows the iterative scheme for the time-average calculation.



Average exit irradiation shown in n/kb

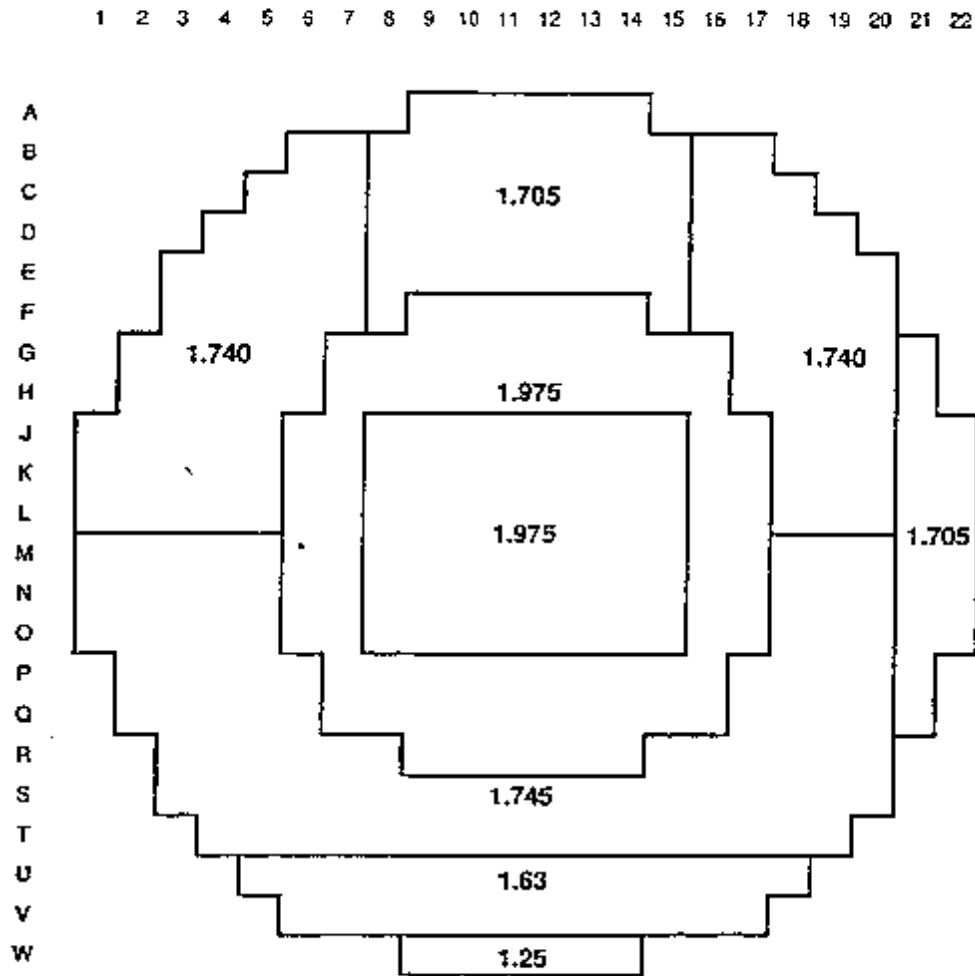

Multiple-Region Time-Average Model for CANDU 6

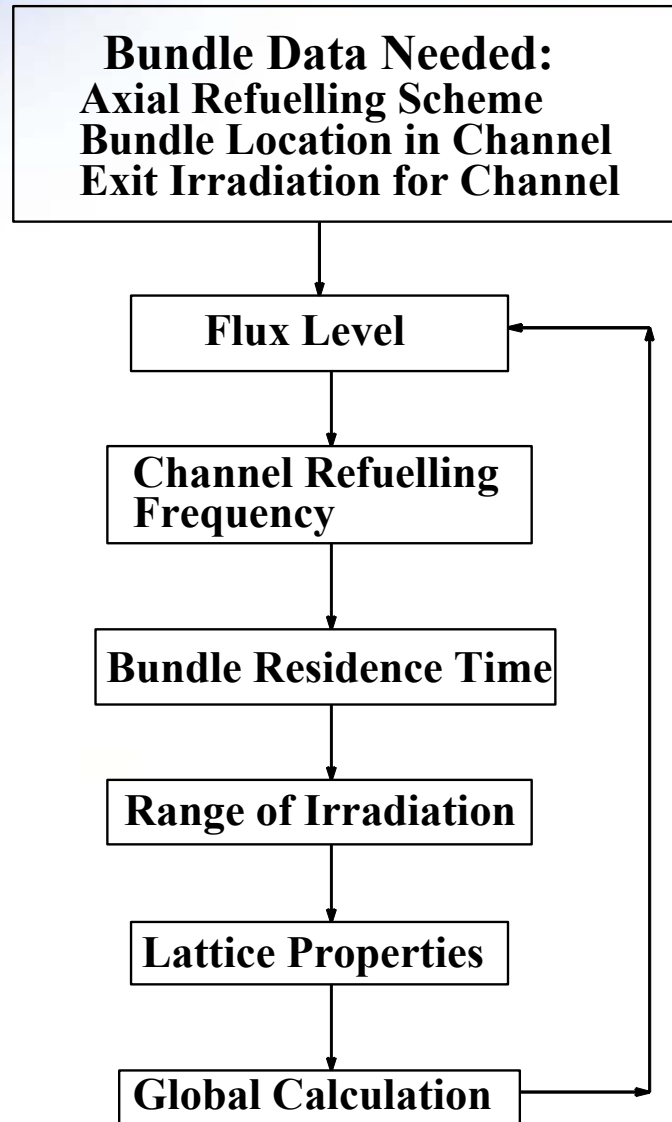



Time-Average Model

- **The time-average model is useful at the design stage, to determine the reference 3-d power distribution, the expected refuelling frequency of each channel (or its inverse, the channel dwell time), and the expected value of discharge burnup for the various channels.**
- **The next Figure shows a typical time-average channel-power distribution.**
- **The following Figure shows typical channel dwell times.**
- **These range typically between 150 and 160 full-power days (FPD) in the inner core, and up to almost 300 FPD for some channels at the outermost periphery of the core.**

A									3287	3379	3468	3468	3379	3287												
B					2962	3581	3948	4332	4504	4568	4568	4504	4332	3948	3581	2962										
C					3271	3881	4579	4933	5337	5473	5475	5475	5472	5332	4933	4578	3881	3271								
D					3360	4060	4767	5429	5741	6059	6144	6064	6064	6144	6059	5741	5429	4762	4060	3360						
E					3205	4032	4778	5476	6000	6243	6437	6478	6368	6368	6476	6437	6242	6000	5476	4778	4031	3205				
F					3848	4655	5281	5821	6246	6400	6357	6372	6317	6317	6372	6357	6400	6246	5820	5280	4655	3849				
G					3438	4362	5155	5608	6037	6330	6429	6363	6390	6412	6412	6390	6363	6429	6330	6037	5608	5155	4362	3434		
H					3944	4855	5573	5895	6203	6405	6464	6379	6404	6434	6434	6404	6379	6464	6405	6202	5895	5573	4855	3944		
J					3210	4280	5224	5887	6097	6243	6363	6383	6347	6359	6351	6351	6359	6347	6383	6362	6243	6097	5887	5224	4280	3210
K					3430	4501	5504	6111	6209	6287	6373	6378	6312	6287	6189	6189	6287	6312	6378	6373	6287	6209	6111	5504	4501	3430
L					3573	4718	5661	6273	6411	6449	6430	6399	6302	6254	6124	6124	6254	6302	6399	6430	6449	6411	6273	5661	4718	3573
M					3587	4732	5688	6320	6487	6523	6475	6430	6320	6270	6138	6138	6270	6320	6430	6475	6523	6487	6320	5688	4732	3587
N					3448	4506	5569	6235	6452	6523	6491	6455	6360	6328	6278	6278	6328	6360	6455	6491	6523	6451	6235	5569	4596	3448
O					3229	4315	5300	6010	6377	6473	6485	6477	6407	6416	6410	6410	6416	6407	6477	6485	6473	6377	6010	5300	4315	3229
P					3963	4888	5631	5985	6296	6473	6527	6427	6472	6515	6515	6472	6427	6527	6473	6296	5985	5631	4888	3963		
Q					3472	4340	5131	5571	6007	6377	6444	6410	6487	6523	6523	6467	6410	6443	6377	6007	5571	5131	4349	3472		
R					3794	4555	5103	5657	6174	6370	6379	6448	6483	6483	6448	6379	6370	6174	5657	5102	4555	3794				
S					3130	3901	4552	5218	5893	6182	6433	6507	6436	6436	6507	6433	6182	5893	5217	4552	3901	3130				
T					3751	4630	5441	5735	6273	6427	6127	6051	6051	6127	6027	5672	5335	4841	3930	3751						
U					3190	3808	4504	4869	5282	5470	5389	5389	5470	5282	4889	4504	3807	3190								
V					2914	3528	3893	4286	4456	4527	4527	4456	4286	3897	3528	2914										
W									3251	3344	3444	3444	3444	3444	3344	3251										

—— BOUNDARIES OF RADIAL ZONES
 - - - - BOUNDARY OF INNER BURNUP REGION

ALL CHANNEL POWERS ARE IN KW (IN)

Channel-Power Distribution from a CANDU 6 Time-Average Calculation

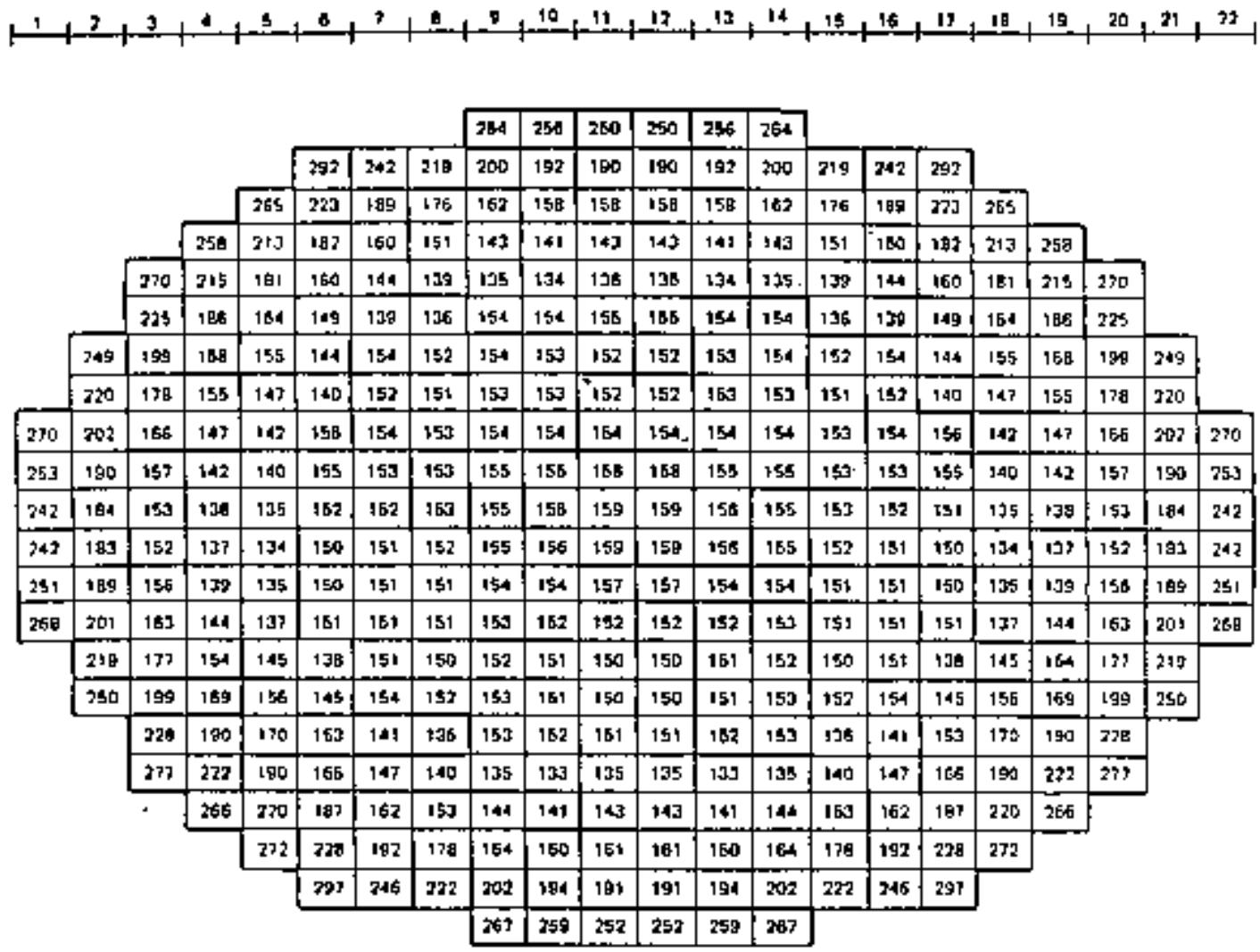

——— { OUTER - REACTOR OUTER BOUNDARY
 INNER - BOUNDARY BETWEEN INNER AND OUTER BURNUP REGIONS



Neutron Balance in Core

- It is instructive to look at a typical neutron balance in the CANDU-6 equilibrium core. This is displayed in the next Figure.
- > 45% of fission neutrons originate from fissions in plutonium: contributes ~ half the fission energy produced in a CANDU reactor. (Actually, in fuel near the exit burnup, plutonium contributes about 3/4 of the fission energy.)
- Fast fissions account for 56 fission neutrons out of 1,000.
- Total neutron leakage is 29 neutrons lost per 1000 born, a 29-mk loss (6 mk from fast leakage, 23 mk from thermal leakage).
- Resonance absorption in ^{238}U represents a loss of almost 90 mk.
- Parasitic absorption in non-fuel components of the lattice represents a 63-mk loss.

Typical Neutron Balance in CANDU 6 (Time-Average Core)



Neutron Energy

PRODUCTION: Total 1000 n
491.9 n from U-235 Thermal Fission
438.4 n from Pu-239 Thermal Fission
13.2 n from Pu-241 Thermal Fission
56.5 n from U-238 Fast Fission

FAST LEAKAGE: 6.0 n

FAST ABSORPTION IN FUEL: 31.7 n

SLOWING DOWN

RESONANCE ABSORPTION IN U-238: 89.4 n

THERMAL LEAKAGE: 23.0 n

THERMAL ABSORPTION: 849.9 n

THERMAL ABSORPTION IN NON-FUEL CORE COMPONENTS: Total 63.4 n
6.2 n in Fuel Sheaths
19.0 n in Pressure Tube
8.5 n in Calandria Tube
14.4 n in Moderator
15.0 n in Adjusters, Zone Controllers and Other Tubes
0.3 n in Coolant

THERMAL ABSORPTION IN FUEL: Total 786.5 n
242.3 n in U-235
238.2 n in U-238
228.1 n in Pu-239
15.6 n in Pu-240
6.2 n in Pu-241
0.1 n in Pu-242
0.6 n in Np
55.4 n in Fission Products (of which 25.2 in Xe, 7.7 in Sm, 2.6 in Rh, 19.9 in others)



Fuel Management - Infinite-Lattice Multiplication Constant

- The infinite-lattice multiplication constant k_{∞} is a measure of the multiplicative properties of the lattice in the absence of leakage from the lattice cell.
- The k_{∞} can be calculated from the basic-lattice cross sections provided by the cell code, and applies to the “ideal” situation of an infinite array of identical cells.
- The lattice is ~ 80 milli-k supercritical for fresh fuel (i.e., at zero irradiation).
- The reactivity increases at first with increasing irradiation, reaching a maximum at ~0.4-0.5 n/kb, a phenomenon due to the production of plutonium from neutron absorption in ^{238}U . This reactivity maximum is consequently known as the plutonium peak.



REACTIVITY OF 37-ELEMENT NATURAL FUEL VERSUS IRRADIATION

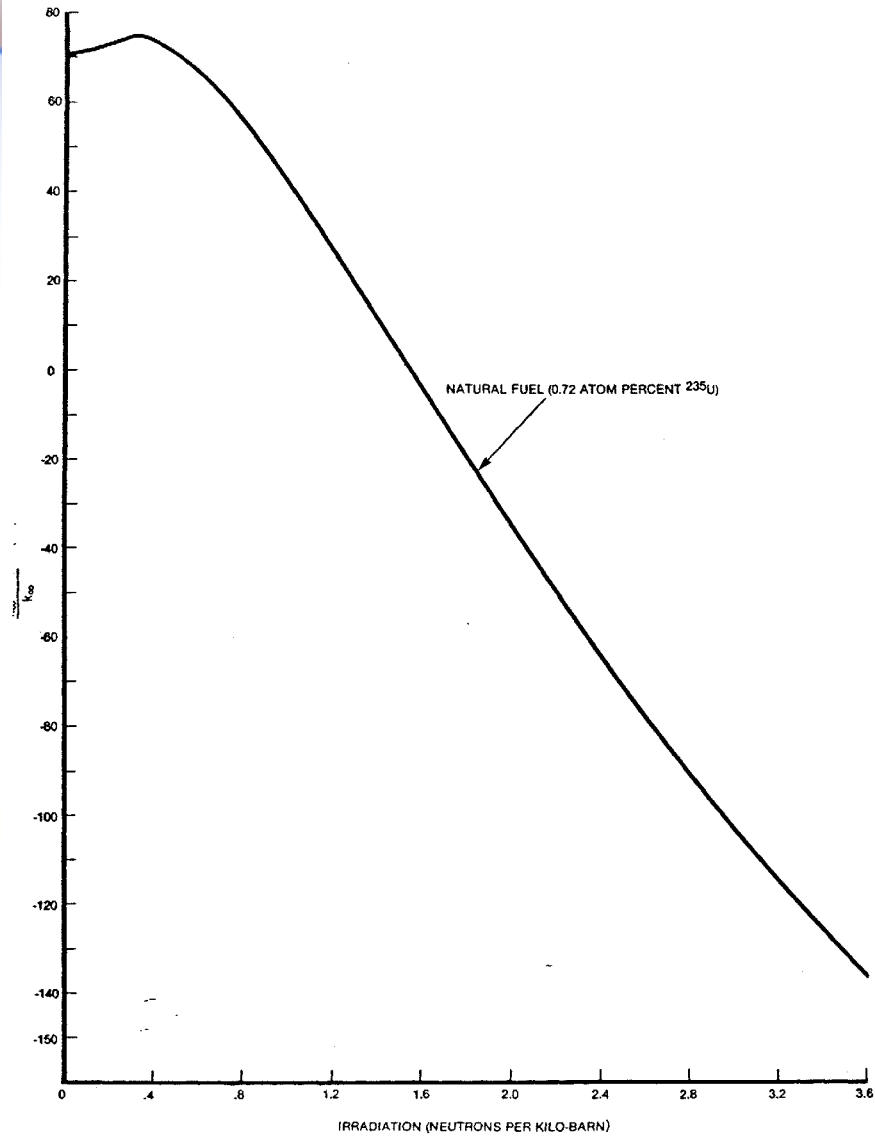

**Infinite-Lattice Multiplication Constant for Standard CANDU-6 Lattice
Fuelled with Natural Uranium**



Infinite-Lattice Multiplication Constant

- Beyond the plutonium peak, the reactivity starts to decrease with increasing irradiation, on account of the continuing depletion of ^{235}U and the increasing fission-product load.
- The lattice reaches zero excess reactivity at an irradiation of about 1.6-1.8 n/kb.
- This marks a natural point at which the fuel can be targeted for removal from the core, since at higher irradiations the lattice becomes increasingly subcritical, i.e., an increasing net absorber of neutrons.
- Thus, channels containing fuel approaching or exceeding these irradiation values become good candidates for refuelling.



Infinite-Lattice Multiplication Constant

- It is instructive to examine also the infinite-lattice multiplication constant for the depleted-uranium lattice (next Figure)
- Here the initial fissile content is 0.52 atom %, as opposed to 0.72 atom % for natural uranium.
- The plutonium peak is even more pronounced for depleted uranium - the role of ^{238}U conversion to plutonium is relatively greater for the smaller ^{235}U content.
- The depleted-uranium lattice is subcritical at all irradiations, i.e. is always a neutron absorber.
- This explains the use of depleted fuel to reduce excess reactivity, and also flatten the flux distribution, in the initial core. Depleted fuel is also occasionally used to reduce the power ripple on refuelling.



REACTIVITY OF 37-ELEMENT DEPLETED FUEL VERSUS IRRADIATION

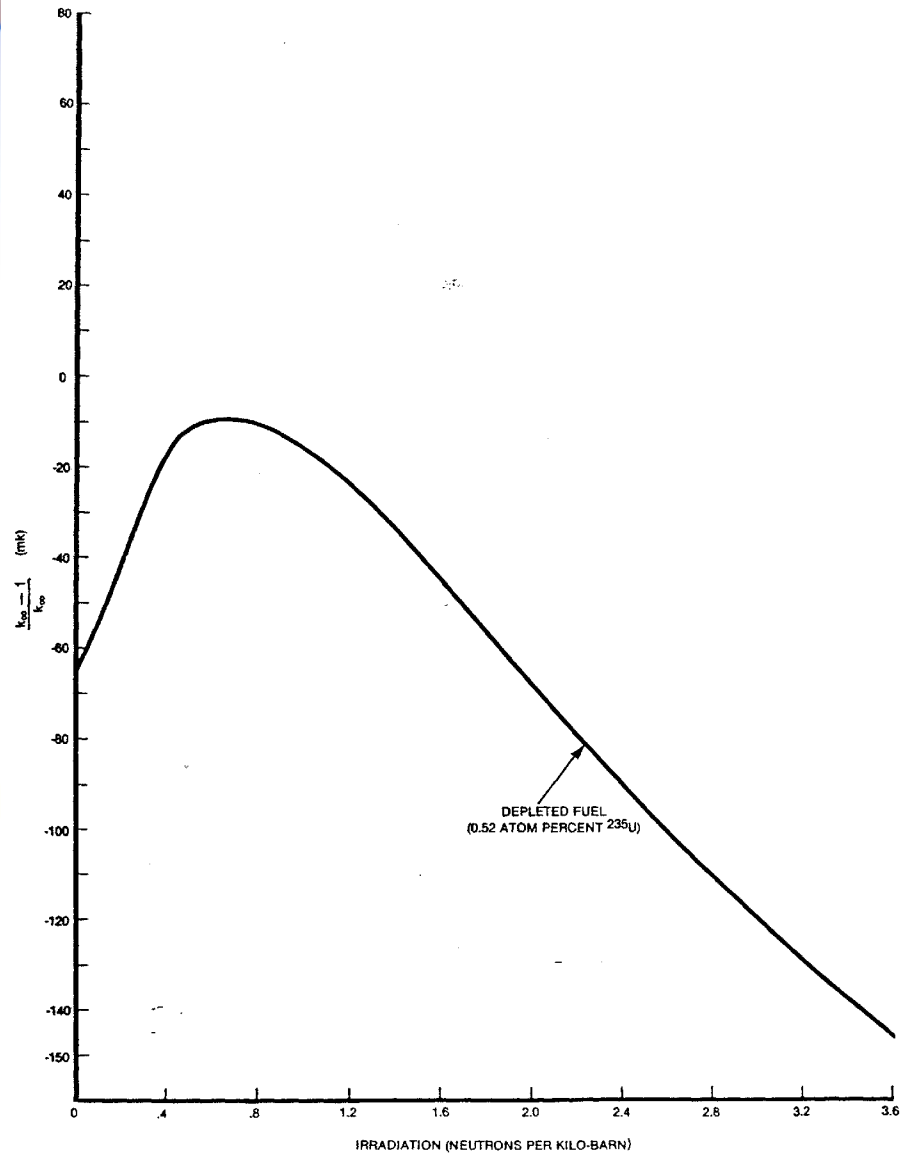

Infinite-Lattice Multiplication Constant for Standard CANDU-6

Lattice-Fuelled with Depleted Uranium



Radial Flattening of Power Distribution

- The 3-d flux distribution depends on reactor size and geometry and on irradiation distribution.
- Fuel with a high irradiation has low reactivity, and depresses flux in its vicinity. Conversely, flux is relatively high where fuel has low irradiation.
- Radial flux and power flattening can be achieved by differential fuelling, i.e. taking the fuel to a higher burnup in inner core than in outer core (cf. previous Figure of multi-region model).
- This is done by judicious adjustment of the relative refuelling rates in different core regions.
- In this way the flux and power in the outer region can be increased, with greater number of channels with power close to the maximum.
- A higher total reactor power can be obtained (for a given number of fuel channels) without exceeding the limit on individual channel power. This reduces the capital cost of the reactor per installed kW.



Equilibrium (Time-Average) Core

- A consequence of the on-power refuelling in CANDU is that the equilibrium core contains fuel at a range of burnups, from 0 to some average exit-burnup value.
- The average in-core irradiation is fairly constant over time, at about half the exit value.
- The long-term global flux and power distributions in the equilibrium core can be considered as a constant, “time-average”, shape, with local “refuelling ripples” due to the refuelling of individual channels.
- These ripples are due to the various instantaneous values of fuel burnup in the different channels, which are the result on any given day of the specific sequence of channels refuelled in the previous days, weeks and months.



On-Going Reactor Operation with Channel Refuellings

- **After the initial period following first reactor startup, on-power refuelling is the primary means of maintaining a CANDU reactor critical.**
- **A number of channels are refuelled every day, on the average.**
- **Replacing irradiated fuel with fresh fuel has immediate consequences on the local power distribution and on the subsequent period of operation of the reactor.**



Channel-Power Cycle

- When a channel is refuelled, its local reactivity is high, and its power will be several percent higher than its time-average power.
- The fresh fuel in the channel then goes through its plutonium peak as it picks up irradiation. The local reactivity increases for ~40-50 FPD, and the power of the channel increases further. The higher local reactivity promotes a power increase in neighbouring channels.
- Following the plutonium peak, the reactivity of the refuelled channel decreases, and its power drops slowly. About half-way through the dwell time, the power of the channel may be close to the time-average value.
- The reactivity of the channel and its power continue to drop. The channel becomes a net “sink” or absorber of neutrons, and eventually the channel must be refuelled.
- At this time the power of the channel may be 10% or more below its time-average power. When the channel is refuelled, its power may jump by 15 to 20% or even more.



Channel-Power Cycle

- The power of each channel therefore goes through an “oscillation” about the time-average power during every cycle.
- The cycle length is not exactly equal to the dwell time, because channels are not refuelled in a rigorously defined sequence, but are selected for refuelling based on instantaneous, daily information about the core power and irradiation distributions.
- In addition, the CANDU fuelling engineer has flexibility in deciding how the core should be managed, and in fact can decide to modify the global power distribution by changing the refuelling frequency of various channels.
- As individual channels are refuelled, the specific sequence results in variability in the instantaneous peak channel and bundle powers in the core.
- Next Figure shows a schematic plot of the maximum channel power versus time and illustrates difference between maximum time-average channel power, average maximum instantaneous channel power, and absolute maximum channel power.

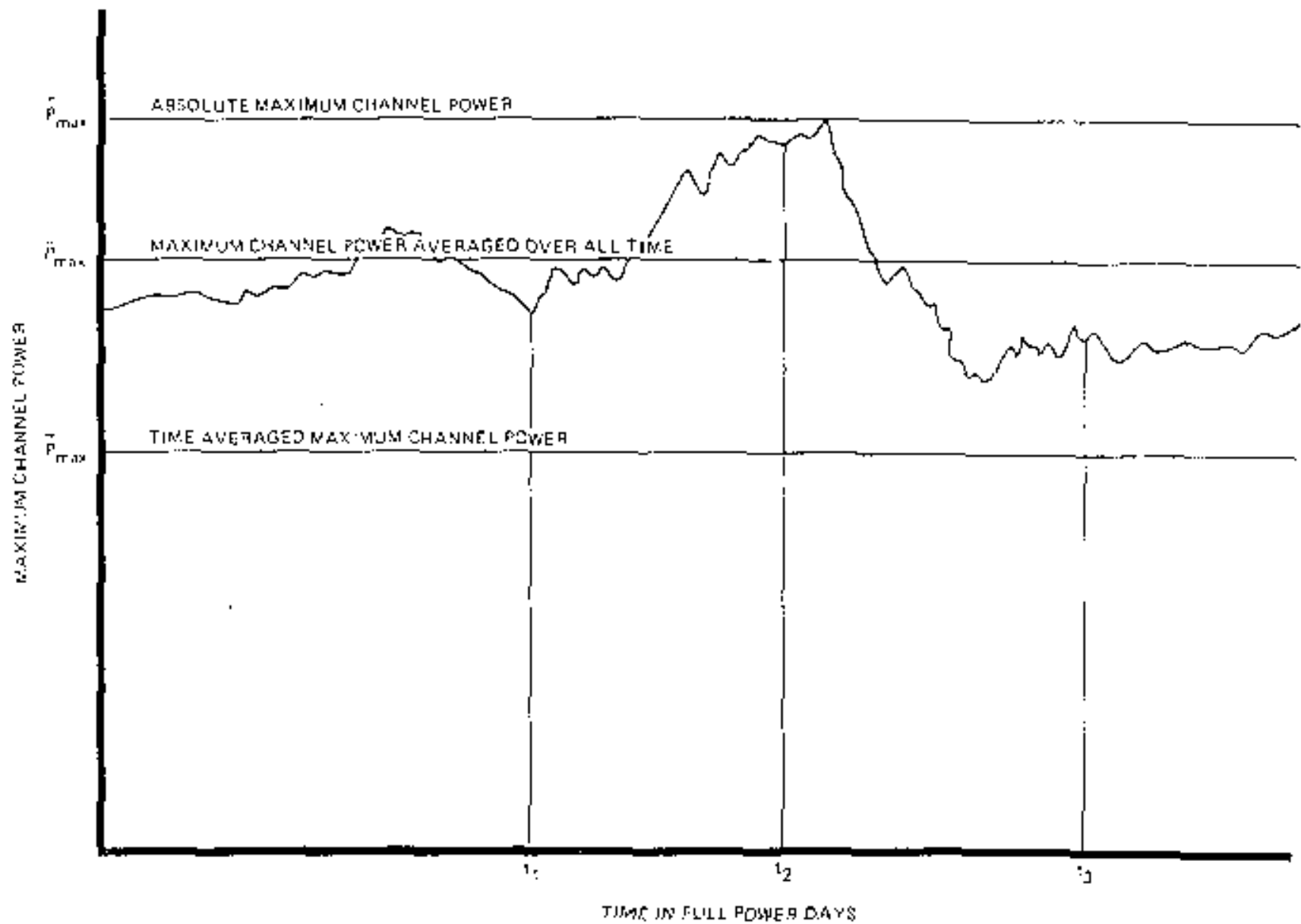

Schematic of Maximum Channel Power versus Time *Pg 155*



Channel-Power Peaking Factor

- **Because many safety analyses are carried out in a time-average model, it is very important to quantify how much higher the instantaneous power distribution peaks above the time-average distribution.**
- **The Channel-Power Peaking Factor (CPPF) is defined as the maximum ratio of instantaneous channel power to time-average power over all channels in the “CPPF Region”, which typically excludes the last two outermost rings of channels.**
- **The CPPF value varies from day to day, as the various channels which have fairly recently been refuelled go through their cycle.**
- **However, the average CPPF depends on the axial refuelling scheme used**
- **The greater the number of bundles replaced at each operation, the greater the reactivity increment, and therefore the greater the CPPF.**
- **With the 8-bundle-shift refuelling scheme, CPPF is typically 1.08-1.10.**



Channel-Power Peaking Factor

- The exact value of CPPF is extremely important because it is used to calibrate the ROP detectors, and therefore affects the operating margin.
- In order to maximize the margin to trip, the CPPF must be kept as low as possible.
- This is why a careful selection of channels to be refuelled needs to be made always.
- Or a 4-bs (or mixed 4-bs and 8-bs) refuelling scheme could be used.
- Determining the daily CPPF value, and ensuring detectors are calibrated to the correct value, are on-going duties of the fuelling engineer or reactor physicist at a CANDU nuclear generating station.



Selecting Channels for Refuelling

- A main function of the fuel engineer is to establish a list of channels to be refuelled during the following few days of operation.
- To achieve this, the current status of the reactor core is determined from computer simulations of reactor operation, the on-line flux mapping system, the ROP and RRS in-core detectors, and zone-control-compartment water fills.
- The computer simulations of reactor operation provide the instantaneous 3-dimensional flux, power and burnup distributions.
- Normally, channel selection will begin with eliminating channels which are poor candidates for refuelling, e.g.:
 - channels with high power, high power peaking factor, or low burnup, or channels which have been refuelled recently, or their neighbours.



Selecting Channels for Refuelling

- **Good combinations of channels for refuelling in the few days to follow will typically contain:**
 - channels last refuelled approximately one dwell time prior
 - channels with high current exit burnup
 - channels with low power, relative to their time-average power
 - channels in (relatively) low-power zones
 - channels which promote axial, radial and azimuthal symmetry and a power distribution close to the reference power shape
 - channels which provide sufficient distance to one another and to recently refuelled channels to avoid hot spots
 - channels which will result in acceptable values for the individual zone-controller fills (20%-70% range), and
 - channels which provide the required reactivity to leave the average zone fill in the desired operational range: 40-60%.



Initial Fuel Load

- In the initial core, all fuel is fresh: no differential burnup to assist in flattening the power distribution.
- The power of the central core region would be unacceptably high without flattening the radial power distribution were provided.
- Depleted fuel is used to reduce channel powers in central core region.
- In the CANDU-6 initial fuel load, 2 depleted-fuel bundles (0.52 atom % ^{235}U) are placed in each of the central 80 fuel channels (see next Figure).
- The bundles are located in positions 8 and 9 (from the channel refuelling end).
- In these axial positions, the depleted-fuel bundles are removed from the core in the first refuelling visit of each of these channels.

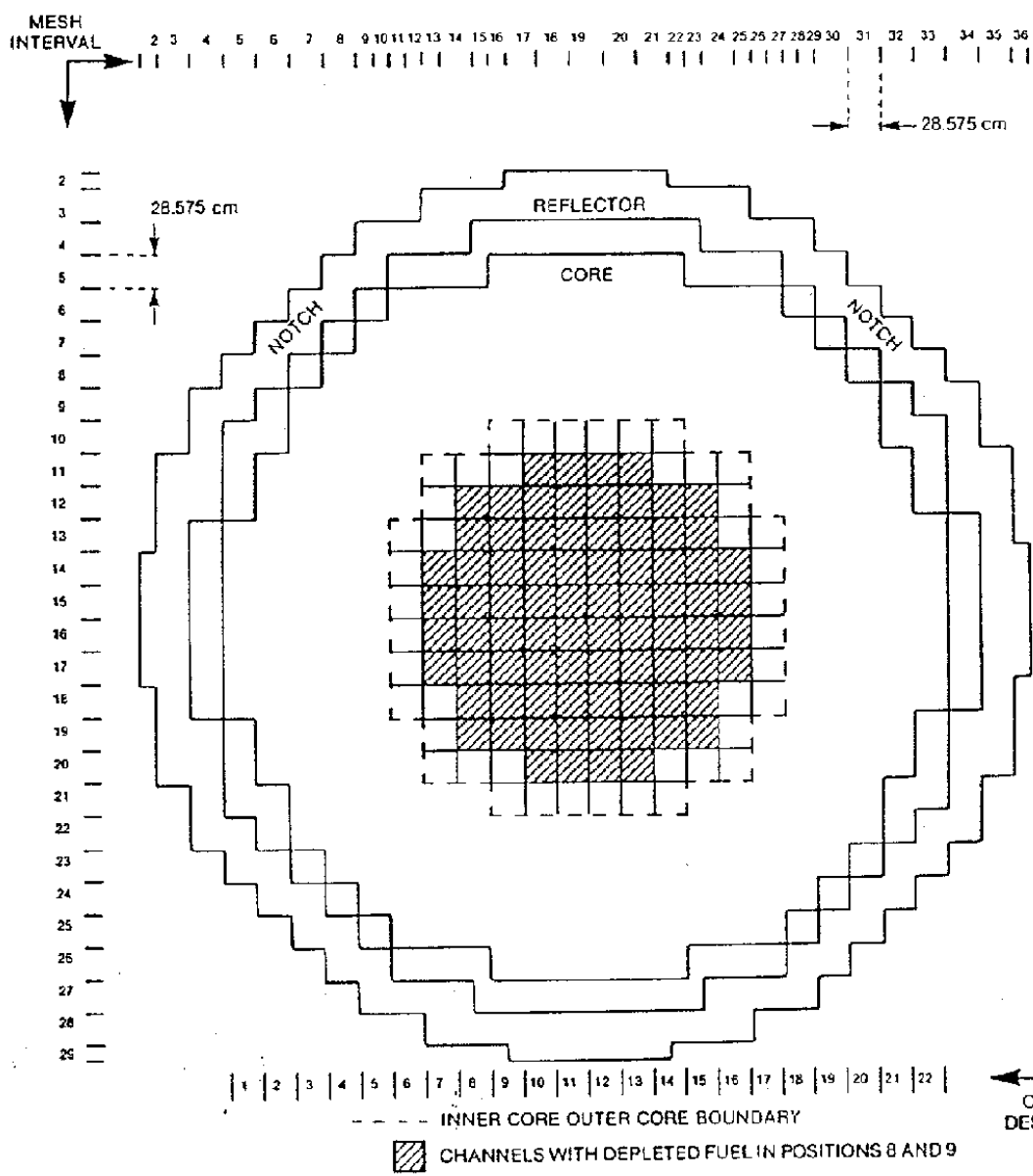

Channels with Depleted Fuel in Initial Core of CANDU 6



Transient to Onset of Refuelling

- Even with some depleted fuel in core, the initial core has a net excess reactivity: ~ 16 mk at full power on FPD 0.
- The reactivity then varies with time as shown in the next Figure.
- All the fuel goes through its plutonium peak at about the same time, the excess reactivity initially increases, to ~ 23 mk around FPD 40-50.
- The excess reactivity is compensated by boron in the moderator: ~ 2 ppm on FPD 0, rising to ~ 3 ppm at the plutonium peak.
- Following the plutonium peak, boron is removed (by ion exchange) as the excess reactivity drops gradually to zero at about FPD 120.
- Refuelling starts about 10-20 FPD before the excess reactivity reaches 0, i.e. around FPD 100, because the refuelling rate would be too great if one waited until the last possible moment to start.
- The rate of refuelling rapidly approaches equilibrium value (~ 16 bundles per FPD for the CANDU 6).

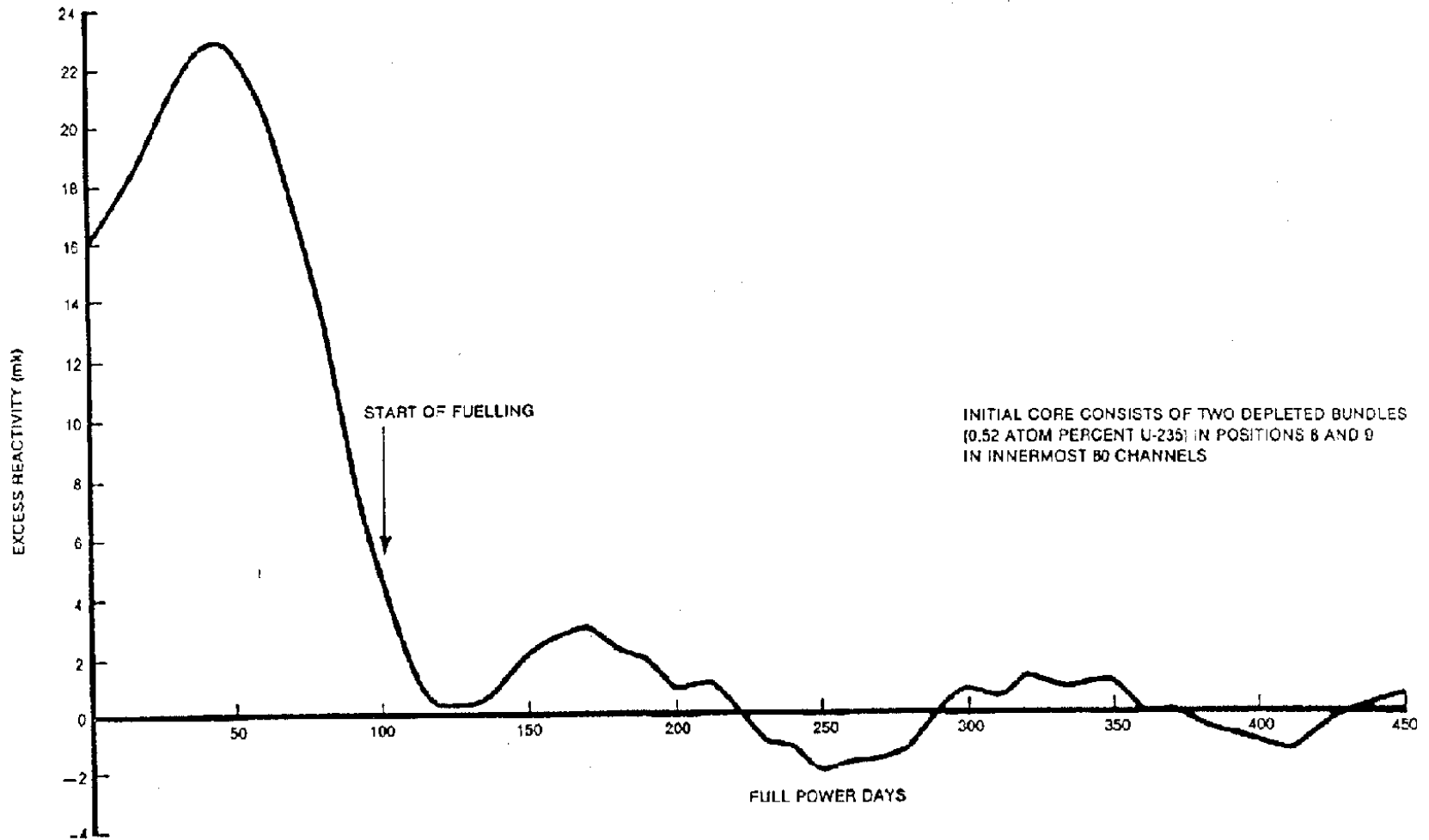



Fuelling-Machine Unavailability

- **If refuelling were to stop, core reactivity would continuously decrease, at ~ 0.4 mk/FPD in the CANDU 6.**
- **First action of RRS to maintain criticality: lower zone-controller water fills from operating range ($\sim 50\%$). To 0%, this would give ~ 3.5 mk, or ~ 7 -8 extra days of operation.**
- **Operator would ensure any moderator poison is removed.**
- **Continued lack of refuelling would lead to withdrawal of adjuster rods in their normal sequence - permits operation to continue for several weeks.**
- **However, as adjuster rods are withdrawn, reactor power must be gradually reduced because of radially “peaked” power distribution - forces power derating to remain in compliance with licensed maximum channel and bundle powers (7.3 MW and 935 kW).**
- **Amount of derating increases with number of adjusters withdrawn.**



Core-Follow Calculations with RFSP-IST

- Main application of RFSP-IST at CANDU sites is tracking the reactor's operating history (core-follow) - performed with *SIMULATE module.
- Core history is tracked by series of instantaneous snapshots, calculated typically in steps of 2-3 FPD.
- The code advances in-core irradiation distributions at each step, and accounts for channel refuellings as they occur.
- Other code inputs: zone-control-compartment fills, concentration of moderator poison, any other device movement.
- Code can model spatial distribution of ^{135}Xe and effect on lattice properties and on flux distribution.
- Bulk and spatial control can also be modelled.
- Core tracking can also be done using the flux-mapping method, using the detector readings. Even in this option, the diffusion calculation is performed, because results are optimized when the diffusion solution is used as the fundamental mode.



Effects of ^{135}Xe

- The xenon isotope ^{135}Xe plays an important role in any power reactor.
- It has a very large absorption cross section for thermal neutrons and represents a considerable load on the chain reaction.
- The ^{135}Xe concentration has an impact on the power distribution,
- and in turn is affected by the power distribution, by changes in power, and by movements of reactivity devices.
- The large absorption cross section of ^{135}Xe plays a significant role in the overall neutron balance in the reactor, and directly affects the system reactivity, both in steady state and in transients.
- The $^{135}\text{Xe}/^{135}\text{I}$ kinetics also influences the spatial power distribution in the reactor.



The Xe-I Kinetics

- The $^{135}\text{Xe}/^{135}\text{I}$ kinetics are shown schematically in the next Figure.
- ^{135}Xe is produced to some degree directly in fission, but mostly as the result of the beta decay of its precursor ^{135}I (which has a half-life of 6.585 hours).
- ^{135}Xe is destroyed in two ways:
 - through its own radioactive decay (^{135}Xe has a half-life of 9.169 hours), and by absorption of neutrons to form ^{136}Xe ,
 - ^{135}I is a direct product of fission, but can also appear through the radioactive decay chain ^{135}Te to ^{135}Sb to ^{135}I .
- ^{135}Te and ^{135}Sb have half-lives which are very short (19.0 s and 1.71 s) compared to those of ^{135}I and of ^{135}Xe ;
- it is sufficient to model the decay of ^{135}Te and ^{135}Sb as “instantaneous”, and add their fission yields to that of ^{135}I .

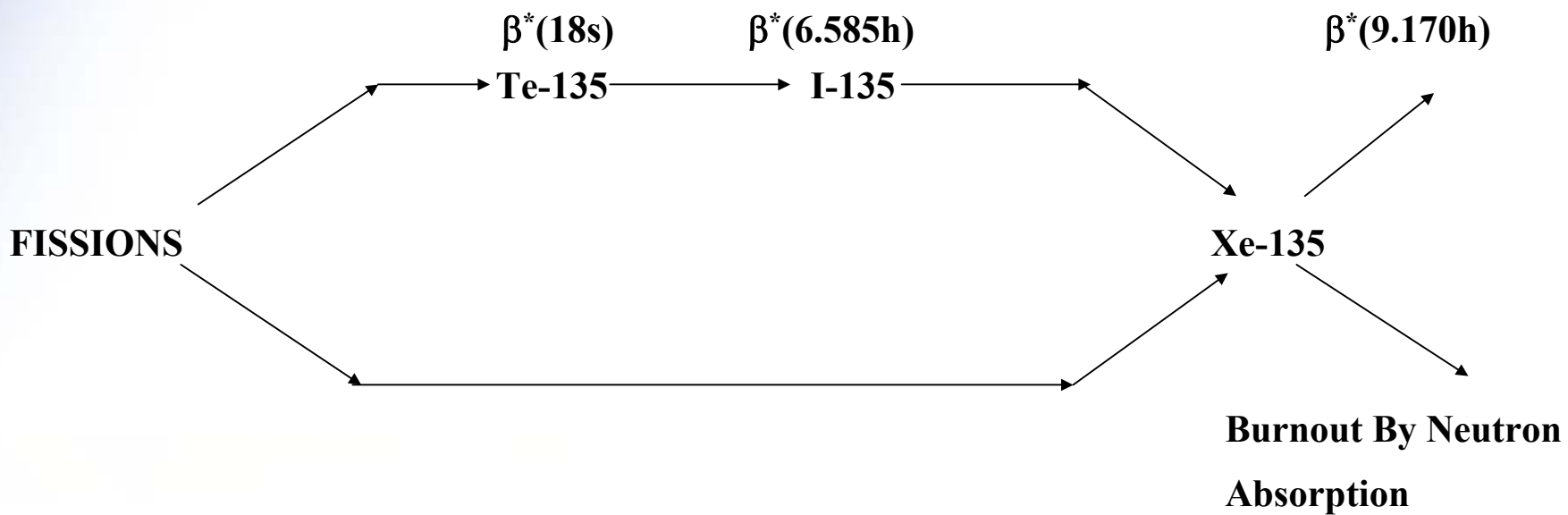

^{135}Xe - ^{135}I Kinetics



Steady-State Xenon Load

- The limiting ^{135}Xe absorption rate at very high flux levels leads to a maximum reactivity of ~ -30 mk.
- In CANDU the equilibrium xenon load is approximately -28 mk.
- The flux level at full power in CANDU is such that the ^{135}Xe concentration is about 95% saturated, i.e., the average ^{135}Xe concentration is equal to about 95% of the value in an infinite flux.



Effects of Xenon on Power Distribution

- Xenon plays a role in the 3-d power distribution in the core.
- Because the steady-state ^{135}Xe concentration depends on the flux, high-power bundles will have a higher xenon load, and therefore a lower reactivity, than low-power bundles of the same irradiation.
- The effect of xenon is therefore to flatten the power distribution: the reduction in the maximum bundle power due to the local ^{135}Xe concentration can be of the order of 5%, and should be taken into account when accurate results are desired.



Effect of Power Changes on Xenon Concentration

- Generally speaking, when the power is reduced from a steady level, the ^{135}Xe concentration increases at first.
- This is due to the fact that ^{135}Xe is still being produced by the decay of ^{135}I ,
- but its burnout rate (by neutron absorption) is decreased because of the reduced neutron flux (reduced power).
- However, after a certain period (depending on the initial and final power and the rate of power reduction)
- the ^{135}I decay rate decreases sufficiently (due to the lower fission rate)
- that the rate of ^{135}Xe production drops below the rate of ^{135}Xe decay (and burnout).
- At this time, then, the ^{135}Xe concentration reaches a peak value and starts to decrease towards a new (lower) steady-state level.



Effect of Power Changes on Xenon Concentration

- Conversely, when the power is increased from a steady level,
- the ^{135}Xe concentration will first decrease,
- and then go through a minimum
- and start increasing again to a higher steady-state level.



Effect of Power Changes on Xenon Concentration

- The next Figure shows some typical reactivity variations due to ^{135}Xe following step reductions in power.
- Very similar variations, but in the opposite direction, ensue upon step increases in power.
- The quantitative effects will be different at different points in the core, due to the initial non-uniform distribution of ^{135}Xe .
- Thus, for an accurate assessment of xenon transients on the power distribution, a point-kinetics treatment is generally inadequate, and calculations in 3-d are required.

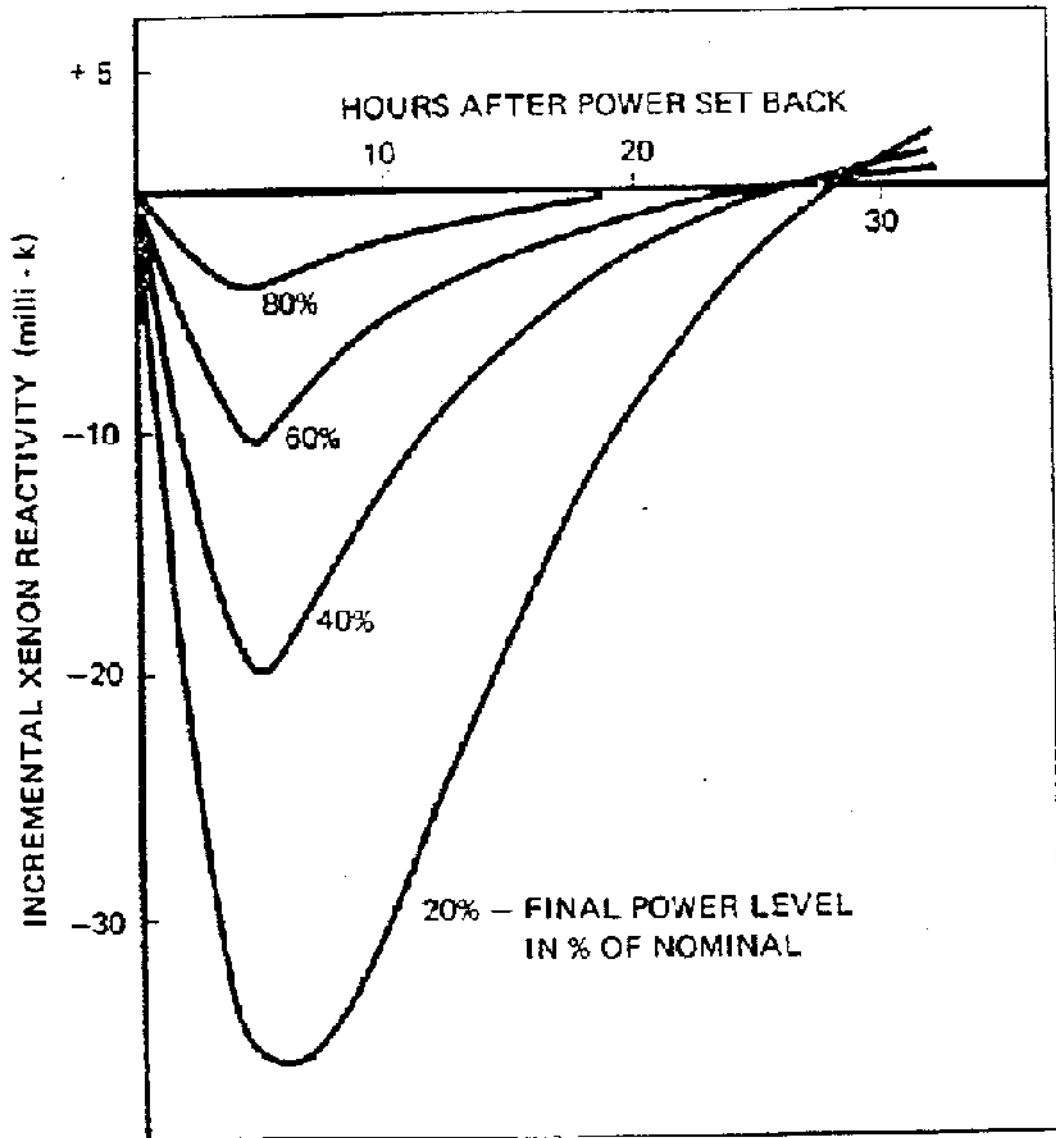

Xenon Reactivity Transients Following Setback to Various Power Levels Pg 174



Xenon Transient Following a Shutdown

- Following a reactor shutdown, the burnout of ^{135}Xe stops,
- whereas the production by means of ^{135}I decay continues for several hours.
- The net result is that there is an initial increase in ^{135}Xe concentration and a decrease in core reactivity.
- If the reactor is required to be started up shortly after shutdown, extra positive reactivity must be supplied.
- The ^{135}Xe growth and decay following a shutdown in a typical CANDU is shown in the next Figure.

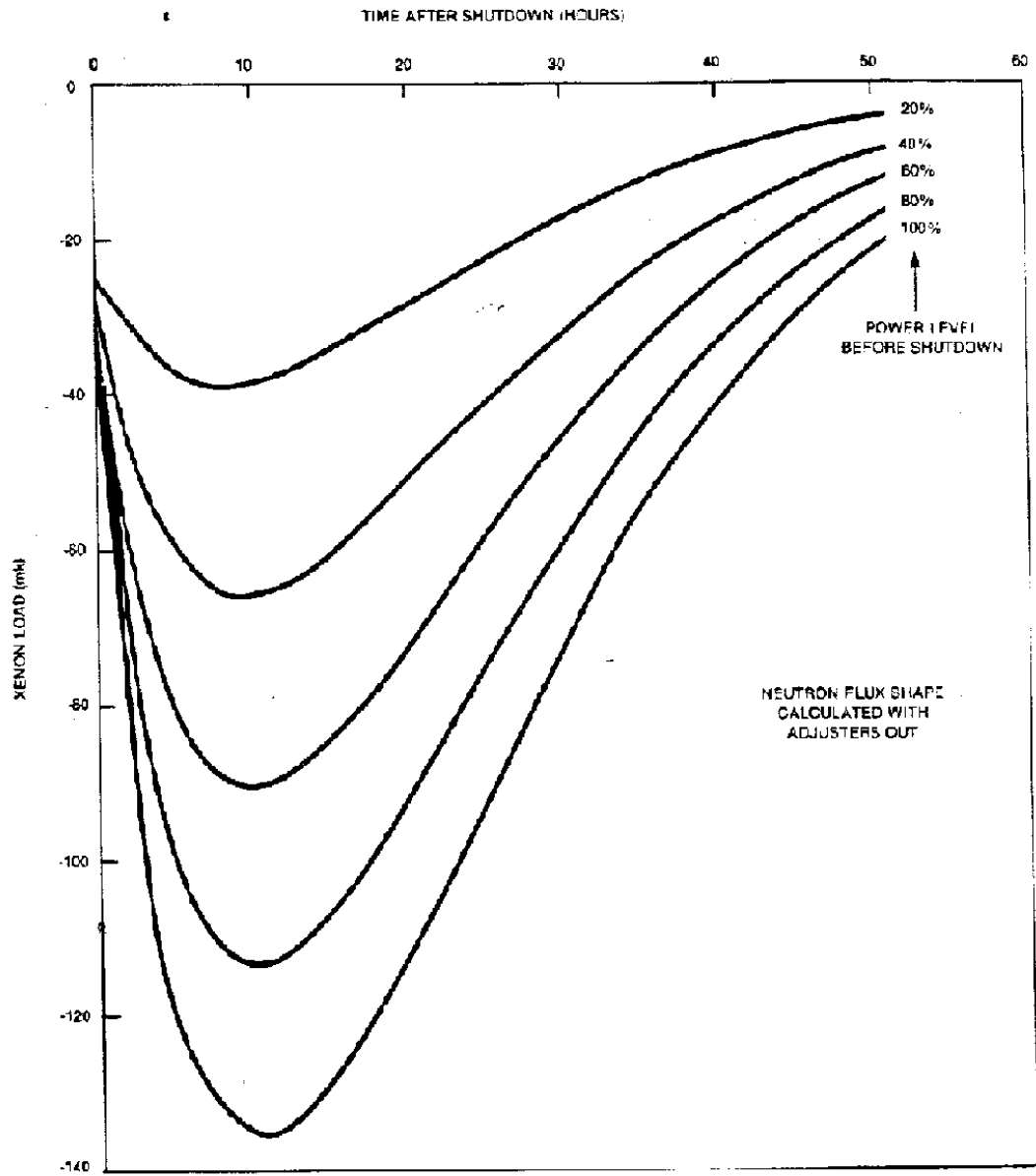

Xenon Transient Following Reactor Shutdown ^{Pg 176}



Xenon Transient Following a Shutdown

- It can be seen that, at about 10 hours after shutdown, the reactivity worth of ^{135}Xe increases to several times its equilibrium full-power value.
- At ~35-40 hours the ^{135}Xe has decayed back to its pre-shutdown level.
- If it were not possible to add positive reactivity during this period, every shutdown would necessarily last some 40 hours, when the reactor would again reach criticality.



Xenon Transient Following a Shutdown

- To achieve xenon “override” and permit power recovery following a shutdown (or reduction in reactor power), the CANDU-6 adjuster rods are withdrawn to provide positive reactivity.
- It is not possible to provide “complete” xenon override capability, this would require > 100 mk of positive reactivity.
- The CANDU-6 adjuster rods provide approximately 15 milli-k of reactivity, which is sufficient for about 30 minutes of xenon override following a shutdown.



Summary

- **Reactor physics has both design and operations aspects.**
- **Design component can be summarized as calculating reactivity, flux and power for assumed core configurations, time-average shape and perturbations.**
- **Operations component is responsibility of the site fuelling engineer or reactor physicist. It involves core-follow calculations, selection of channels for refuelling, and determination of CPPF, used as calibration factor for the ROP detectors.**
- **The job of the design or site reactor physicist is always interesting and stimulating; it never gets boring.**