



ATOMIC ENERGY OF CANADA LIMITED
Power Projects, Sheridan Park, Ontario

Nuclear power symposium

CANADIAN REACTOR FUEL

R.D. Page

HEAD, FUEL ENGINEERING BRANCH

ATOMIC ENERGY OF CANADA LIMITED
Power Projects

NUCLEAR POWER SYMPOSIUM

CANADIAN POWER REACTOR FUEL

by

R. D. Page

PREAMBLE

This paper is intended to introduce the reader to Canada's Power Reactor Fuel. The paper covers the following broad subjects:

- (a) The basic CANDU fuel design.
- (b) The history of the bundle design.
- (c) The significant differences between CANDU¹ and PWR² fuel.
- (d) Bundle manufacture.
- (e) Fissile and structural materials and coolants used in the CANDU fuel program.
- (f) Fuel and material behaviour and performance under irradiation.
- (g) Fuel physics and management.
- (h) Booster rods and reactivity mechanisms.
- (i) Fuel procurement, organization and industry.
- (j) Fuel costs.

1. INTRODUCTION

In Canada the development of power-reactor fuels began some fifteen years ago with the design and manufacture of the first charge for the demonstration power reactor, NPD.³ Early successes are attributed to a deliberate policy of cooperation between Atomic Energy of Canada Limited and private industry. In subsequent years, as the designs were improved and more fuel was manufactured, both the AECL

1 CANDU - Canadian Deuterium Uranium Reactor

2 PWR - Pressurized Water Reactor

3 NPD - Nuclear Power Demonstration

laboratories and private industry grew in maturity. A division of responsibility evolved whereby manufacturing and design know-how became entrusted to private industry while the AECL laboratories concentrated on fundamental studies related to more advanced applications. At the same time fuel management techniques were developed by the Hydro-Electric Power Commission of Ontario¹, the principal customer for nuclear fuel in Canada. Thus, through long-term planning and investment in people and facilities, Canada has built a strong integrated capability for research, development, manufacturing and use of nuclear fuel.

From the beginning, the objective has been to develop power-reactor fuels that are both reliable and inexpensive. To achieve this objective, the fuel has been kept as simple as possible. The bundle consists of only the fuel material and a minimum containment envelope; all related but non-consumable components - such as channels, orifices, control and monitoring equipment, and fuel-handling hardware - are kept as part of the reactor capital equipment. Fabrication techniques are also simple and, whenever possible, are adapted from normal industrial practice. These techniques are susceptible to standardization and automation, and the number of different processes is minimized.

2. FUEL DESIGN

The Pickering bundle shown in Figure 1 is the fuel designer's response to the objective. It is a bundle of 28 closely packed elements, each containing high-density natural UO_2 ² in a thin (0.4 mm) Zircaloy (ref. para 6.2) sheath. Plates welded to the end of the elements hold them together; spacers brazed to the sheaths keep the desired separations. The bundle is ~ 50 cm long and 10 cm in diameter.

The Pickering fuel bundle is 92 wt% UO_2 ; the 8 wt% Zircaloy is made up of the sheaths, end-caps, structural end-plates, and spacers. The structural material accounts for only 0.7% of the thermal neutron cross section of the bundle, to give a fuel assembly that is highly efficient in its use of neutrons. There are only six different types of component, and all the 19,000 bundles that provide the 380 tonnes U for the first charge of the 2,032 MW(e) Pickering Generating Station are identical.

¹ "Ontario Hydro" is an electrical utility with 5,270 MW(e) of CANDU reactors (moderated and cooled with heavy water) in operation and under construction.

² Uranium Dioxide

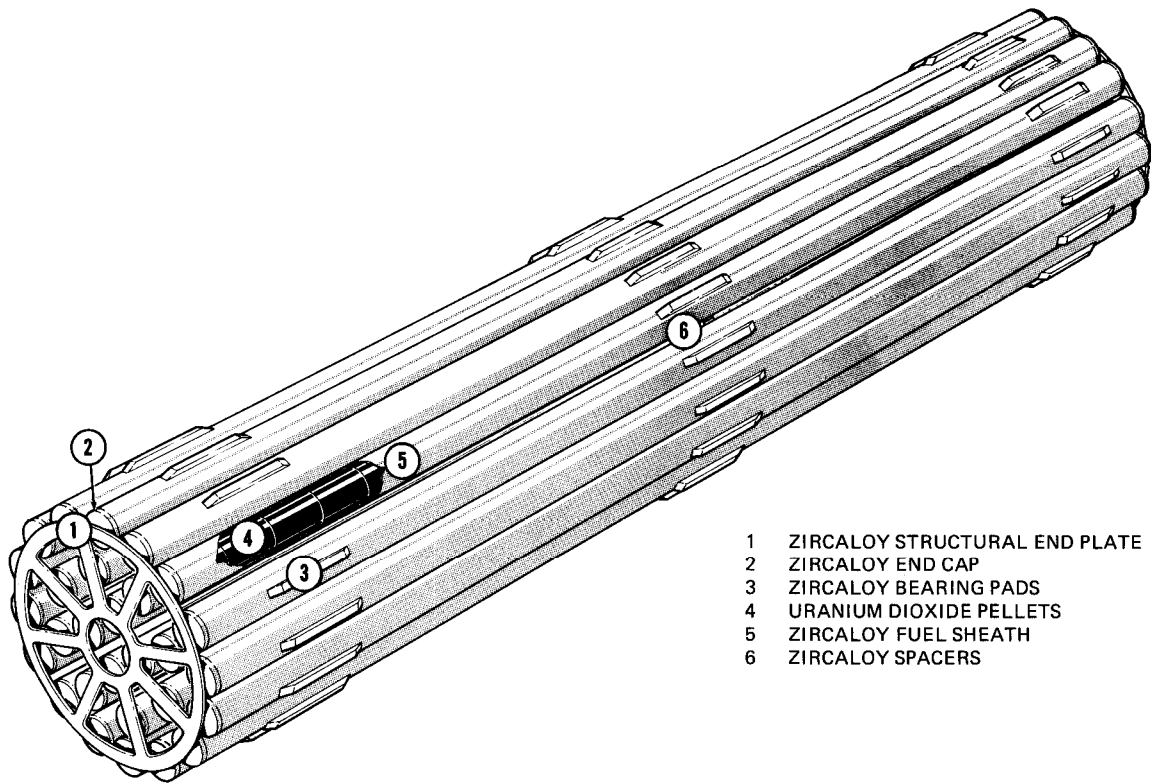

Figure 1 Fuel Bundle for Pickering Reactor
Assembled from Six Basic Components

3. DESIGN AND DEVELOPMENT HISTORY

3.1 Pressurized Heavy Water Fuel - PHW

The design and development of fuel for the CANDU type reactors have been well documented (References 1 through 8); therefore it is only necessary to outline briefly the salient points.

The original fuel charge for NPD contained wire-wrapped (ref. para 5.1) 7-element bundles in the outer zone and 19-element wire wrap bundles in the centre. The 7-element bundle has not been developed further and is being phased out of the reactor. The 19-element bundle design was modified for Douglas Point by changing the wire wrap to a tighter pitch and rearranging the wire wrap array for better mixing. Also wire bearing pads were added to protect the pressure tube and bundle from wear during on-power fuelling. Because of the concern of possible sheath fretting by the wire wrap which spaces the elements apart, the replacement fuel for this reactor utilizes a brazed skewed split spacer (ref. para 5.1) design.

The fuel for the Pickering reactors as described previously uses the same length and diameter of element (495 mm and 15.3 mm) and method of fabrication, but the number of elements has been increased to 28 to fill the 10 cm diameter pressure tube, as shown in Figure 1, compared to the 8 cm diameter pressure tube for NPD and Douglas Point.

For the Bruce reactor we are developing two designs:

- (1) A 28-element bundle similar to the Pickering bundle but operating at higher bundle powers (735 vs 640 kW) with minor changes in bearing pad position and end cap profile.
- (2) A more conservative 37-element bundle of similar construction operating at lower element ratings ($\int \lambda d\theta$ 3.7 vs 4.8 kW/m) (para 7.1.1). See Figure 2.

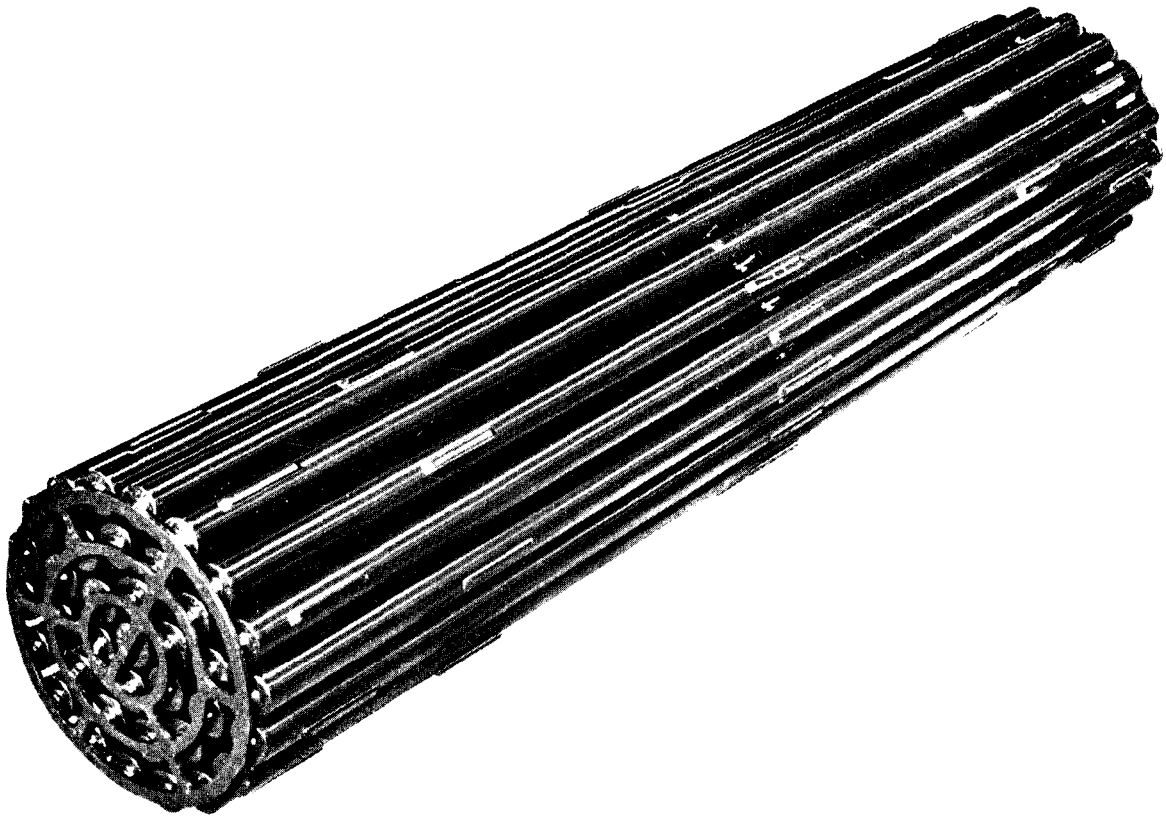

Figure 2 Bruce 37-Element Bundle

3.2 Boiling Light Water Fuel - BLW

The basic design philosophy for the BLW fuel for Gentilly has used, where possible, the technology that has already been developed in the PHW program. However, a number of departures from PHW practice have been necessitated by the particular requirements of the BLW type of reactor.

The most significant of these modifications - a change in both element and bundle design - is due in large part to the fact that in a boiling reactor the maximum heat flux on the fuel is limited by dryout¹. Another important factor in this change is the requirement for BLW reactors to keep the amount of light water in the reactor core to a minimum by means of boiling to high qualities and limiting the coolant flow area within a bundle. Although the Gentilly reactor is based on a 10 cm channel diameter, it was felt that the above requirements could best be met by a 19-element radially pitched bundle rather than the 28-element 10 cm diameter bundle already under development for the Pickering reactor. The specific reasons for this choice were:

- (1) The better general understanding of the thermal and hydraulic performance of the 19-element geometry.
- (2) The greater amount of critical heat flux data available for the 19-element geometry.
- (3) The smaller coolant cross-sectional area in a 19-element geometry than in a 28.

In the case of the design selected, the coolant cross-sectional area was reduced even further by the use of a 1 mm inter-element spacing rather than the 1.27 mm used to date in the PHW program.

A second major change from PHW practice resulted from the need in the Gentilly reactor to have all of the fuel bundles of a channel connected together to permit on-power refuelling from the bottom end of the reactor. To satisfy this requirement, the central element is removed from the basic 19-element configuration and this central vacant site is then used for a structural member which holds the bundles together in a string. This structural member is in the form

¹ Dryout (or critical condition) may be defined as the breakdown of the water film on the surface of a heated fuel element. This breakdown is accompanied by a sudden decrease in the local heat transfer coefficient, and a resultant sharp increase in sheath temperature.

of a gas filled tube with a spring at its lower end which applies a compressive load to the bundles in the string thus preventing relative rotational movement.

The various cross-sections of the fuel bundles mentioned above are shown in Figure 3. The design and operating conditions are listed in Table I, and four examples of the bundles are shown in Figure 4.

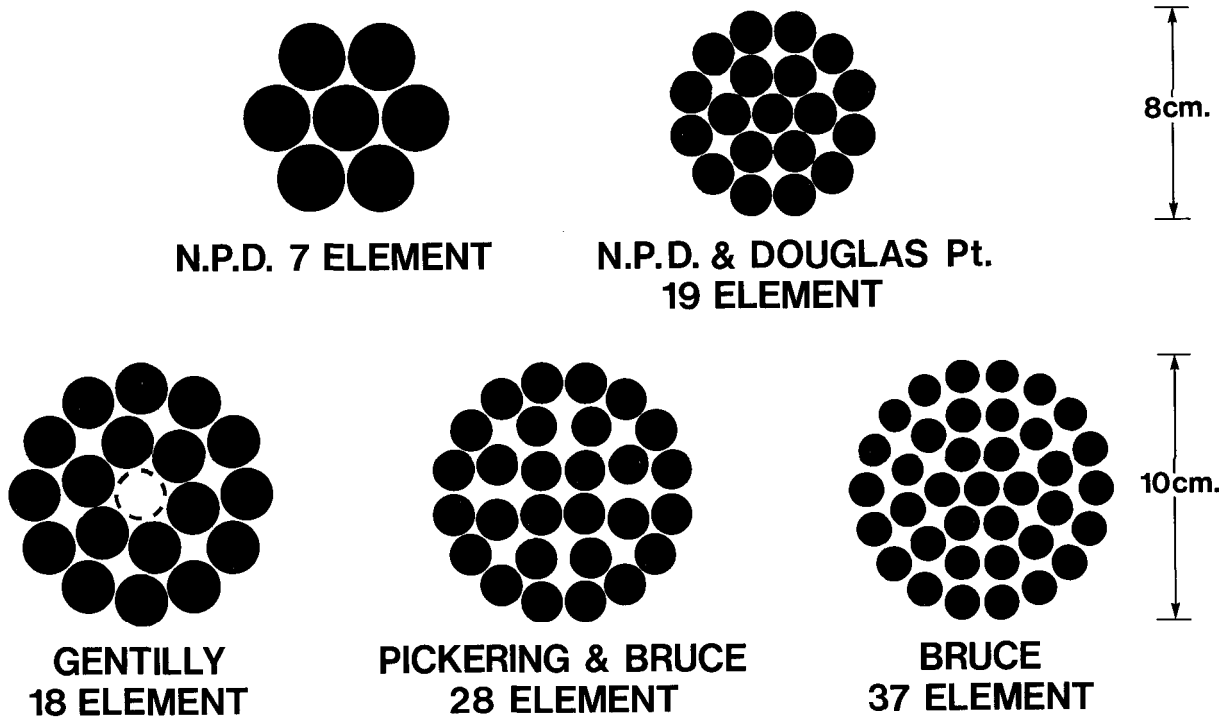

Figure 3 Fuel Bundle Cross-Sections

Table I Canadian Power Reactor Fuel: Design and Operating Data

REACTOR	NPD	NPD	DOUGLAS POINT	PICKERING	BRUCE	BRUCE	BLW GENTILLY	PHW
NUMBER OF ELEMENTS PER BUNDLE	7	19	19	28	28	37	18	37
PELLETS (Sintered UO ₂)								
Density	10.3 ± 0.2	10.3 ± 0.2	10.55 ± 0.15	10.60 ± 0.15	10.60 ± 0.15	10.60 ± 0.15	10.60 ± 0.15	10.60 ± 0.15
O/U Ratio	2-2.02	2-2.015	2-2.015	2-2.015	2-2.015	2-2.015	Optional	2-2.015
Length	22.6	19.8	20.1	20.9	20.9	19		16
ELEMENTS								
Material	Zirc-2	Zirc-2	Zirc-2	Zirc-4	Zirc-4	Zirc-4	Zirc-4	Zirc-4
Outside Diameter	25.4	15.25	15.25	15.24	15.23	13.08	19.74	13.08
Min. Cladding Thickness	0.64	0.38	0.38	0.38	0.38	0.38	0.49	0.38
BUNDLES								
Length	495	495	495	495	495	495	500	495
Maximum Diameter	82.04	82.04	81.69	102.4	102.4	102.4	102.4	102.4
Number per Channel	9	9	12	12	13	13	10	12
Number in Reactive Zone	9	9	10.1	12	12	12	10	12
Spacing Between Elements	1.27	1.27	1.27	1.27	1.27	1.02	1.02	1.02
PRESSURE TUBE								
Minimum Inside Diameter	82.55	82.55	82.55	103.4	103.4	103.4	103.4	103.4
OPERATING CONDITIONS								
Coolant	D ₂ O	D ₂ O	D ₂ O	D ₂ O	D ₂ O	D ₂ O	H ₂ O	D ₂ O
Nominal Inlet Pressure	7.9	7.9	9.8	9.8	9.3	9.3	6.4	11.09
Pressure Drop/Channel								
(measured with fresh bundles)								
- 9 bundles	60.5	169	-	-	-	-	-	-
- 10 bundles	-	-	-	-	-	-	817	-
- 10.1 bundles	-	-	738	-	-	-	-	-
- 12 bundles	-	-	-	565	-	-	-	758
- 13 bundles	-	-	-	-	634	738	-	-
Inlet Temperature	252	252	249	249	252/256*	252/256*	268	266.4
Outlet Temperature	277	277	293	293	298.9	298.9	269.4	312.3
Exit Steam Quality	-	-	-	-	0/3.5*	0/3.5*	16.5	2.9
Max. Mass Flow/Channel	4.69	7.21	12.6	23.8	23.8	23.8	11.4	23.94
Max. Mass Velocity	2530	3650	6630	7210	7170	7170	4340	6998#
Max. Sheath Temperature	288	284	301	304	302	302	286	317
Max. Heat Rating $\int \lambda d\theta$	3.45	1.96	4.0	4.2	4.8	3.7	4.8	4.16
Max. Linear Element Power	43.4	24.6	50.3	52.8	60.3	46.5	60.5	52.30
Max. Linear Bundle Power	298	447	871	1325	1472	1472	968	1610
Average Burnup ± 10%	164	164	192	168**	210	204	168	180
Maximum Surface Heat Flux	544	536	1090	1150	1265	1131	975	1272

* Inner Zone/Outer Zone

** Less than Bruce value because of Cobalt Loaded Adjuster Rods rather than Booster Rods.

Based on cold nominal dimensions and hot fluid properties.

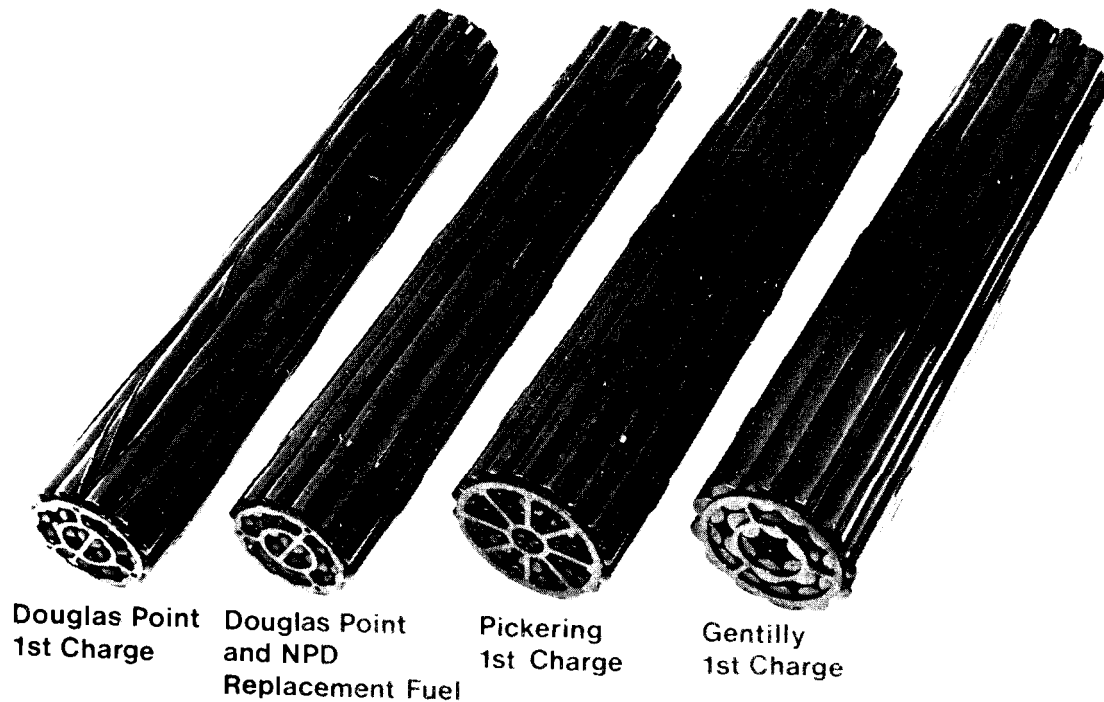

Figure 4 Fuels for Canada's Power Reactors

4. DIFFERENCES BETWEEN CANDU AND PWR

The significant differences between CANDU PHW fuel and that used in American enriched reactors (PWR) are listed in Table II.

The significance of these differences in fuel design are difficult to summarize briefly without going into a detailed comparison between the two reactor systems and their fuel cycles, i. e. , PHW versus PWR, however the following can be stated - enriched fuels are more expensive by a factor of 3 to 4 in total fuel costs.

The major reason for this large difference in costs is the use of enrichment in the PWR reactor fuel cycle. The enriched uranium required is an expensive material and adds many steps to the manufacturing flow sheet. The enriched fuel cycle relies on spent fuel reprocessing to recover the unused fissile uranium, and the plutonium, which are credited to the fuel cycle costs.

The natural uranium cycle has only a few steps and does not claim credit for the plutonium in the spent fuel. But the spent fuel could be

Table II Differences Between CANDU and PWR Fuel

	CANDU PHW	PWR	Ratio $\frac{\text{PWR}}{\text{PHW}}$
Fissile Materials	Natural U 0.7% U ²³⁵	Enriched 1.5 - 3% U ²³⁵	3
Total Fuel Cost	Low	High	3 to 4
Length (Element)	Short	Long	8
Diameter (Element)	Larger	Smaller	0.7
Sheath Thickness	Thin	Thick	1.4
Diametral Gap	Low	High	2.3
Complexity	Simple	Complex	-
UO ₂ Density	High	Low	0.9
Spacing (Element)	Small	Large	2.7
Fuelling	On power	Off power	-
Average Core Burnup	Medium	High	-

sold or the plutonium recycled, if future markets justify it.

Schematics of the natural and enriched uranium cycles are shown in Figures 5 and 6.

Even comparing the fabrication costs of the bundles only, the PHW fuel is approximately one-third the price of PWR fuel.

The difference in complexity of the assembly, dimensions of the sheathing, element diameter, diametral gap, spacing and UO₂ density all affect the neutron efficiency of the fuel assembly.

It should be noted that because PWR fuel is full length, the whole assembly has to be discharged if any part becomes defective. It is possible with the short PHW fuel bundle and on-power fuelling, that only the defective bundle in the channel needs be discharged.

The differences mentioned above contribute to very low fuelling costs for the PHW reactors, i. e., less than 0.9 mils/kWh.

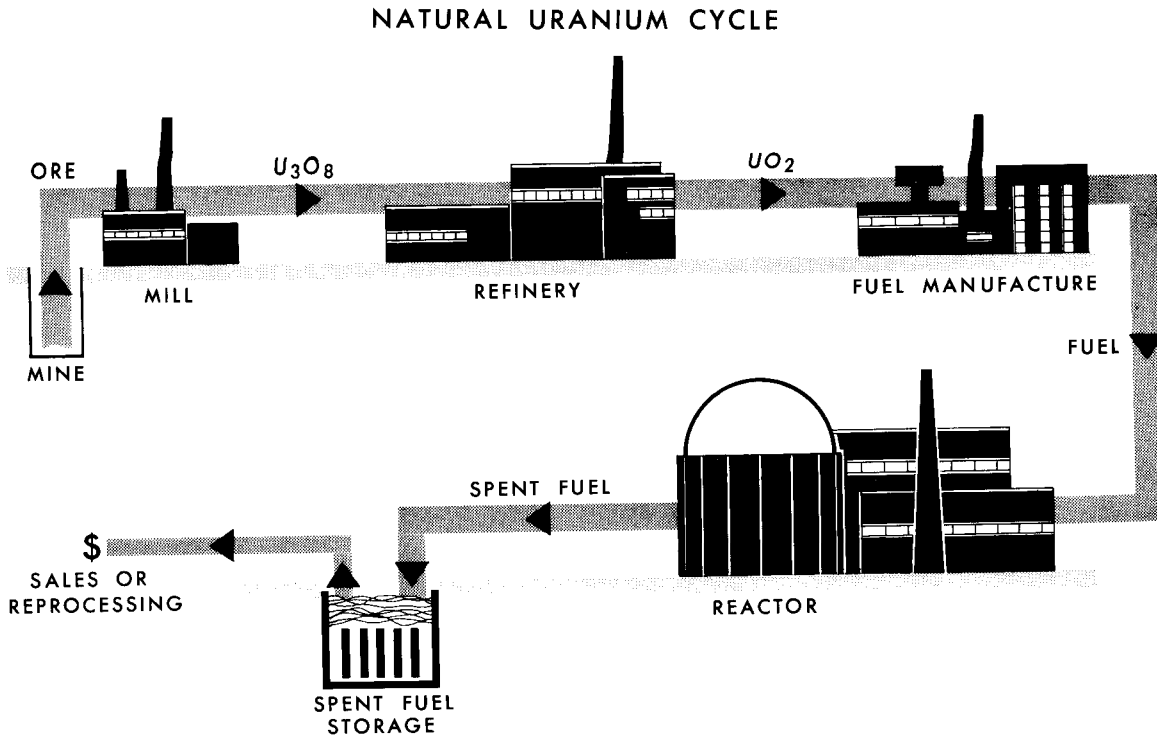

Figure 5 Natural Uranium Cycle

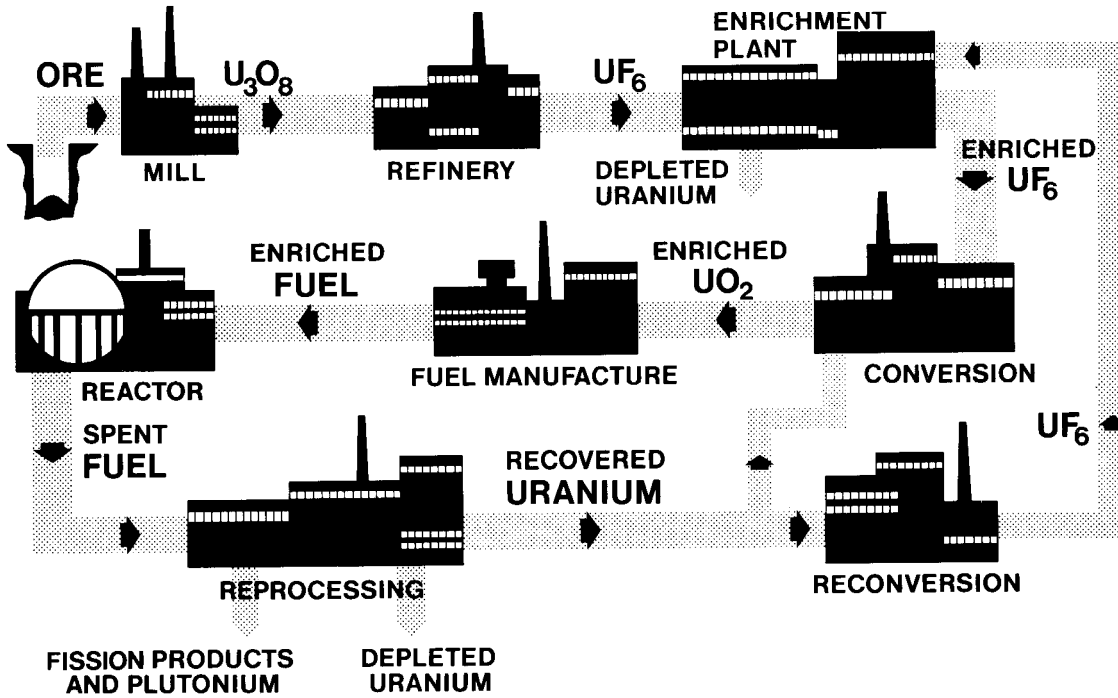

Figure 6 Enriched Uranium Cycle

5. FUEL MANUFACTURE

5.1 History

As already mentioned in Section 3 the original fuel design for NPD was a wire wrapped bundle of both 7 and 19-elements.

The wire wrap which spaced the elements from each other and the pressure tube was spot welded to the sheath, Figure 7(a). The elements were sealed and assembled by Tungsten inert gas welding which is a slow process and a difficult weld to control consistently on an automatic basis.

Therefore, for the Douglas Point bundle, we developed resistance welding for both the end cap to sheath closure and the end plate to end cap joint, Figure 7(b). This method of welding is fast, cheap and can be controlled consistently, lending itself to automation. Cross sections of the joints are shown in Figures 8 and 9.

The brazed split spacer was developed as an alternative to the wire wrap spacer. It is constructed by induction heating the tube and spacer to 1060°C in vacuum to allow the Zr-Be braze to flow. The spacers were skewed to prevent interlocking as shown in Figure 10, and a close-up of the spacer and bearing pads shown in Figure 11, cross section in Figure 12.

The various steps in the production of a fuel bundle are shown in Figure 13 and outlined pictorially in Figures 14, 15, 16, 17.

Canadian fuel relies heavily on detailed quality control at every step in production and the overall quality control program is audited by the utilities inspectors on a continuing basis.

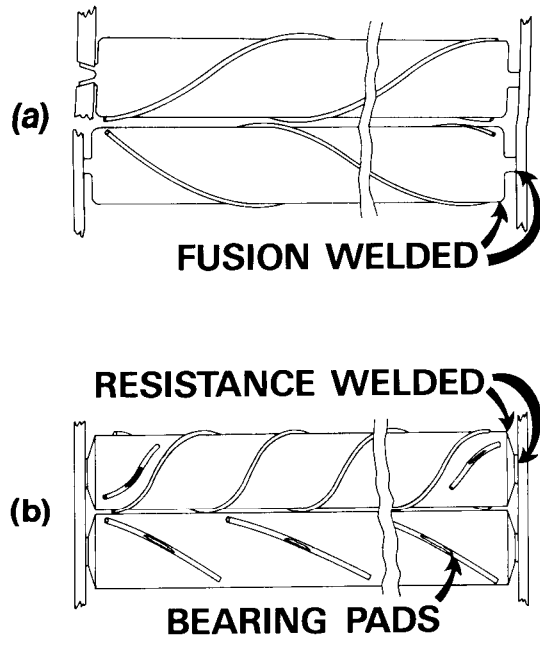

Figure 7 NPD and Douglas Point Wire Wrap Spacing and Bundle Construction

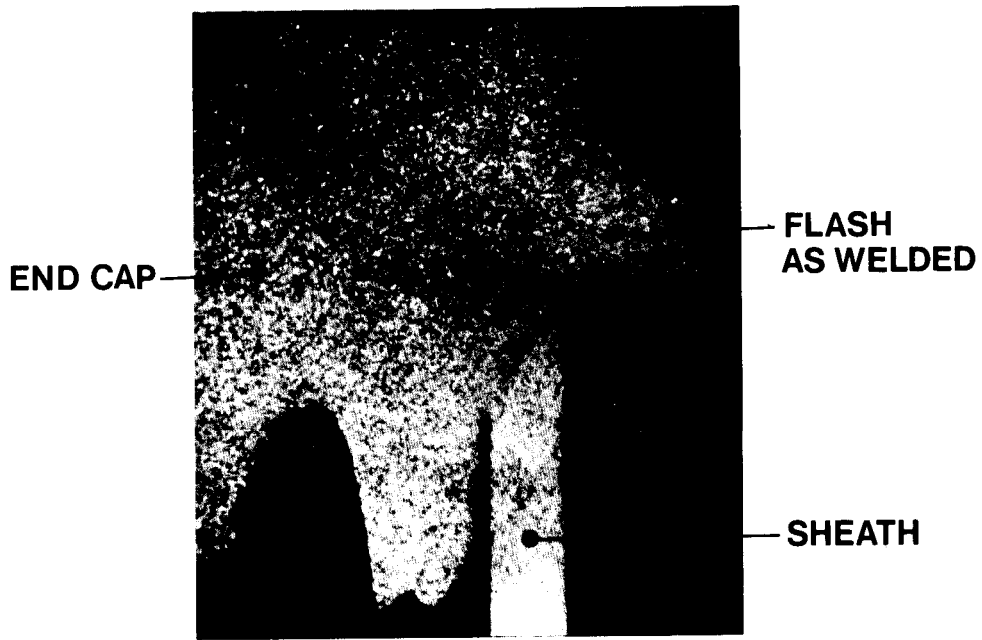

Figure 8 Cross Section Through Closure Weld

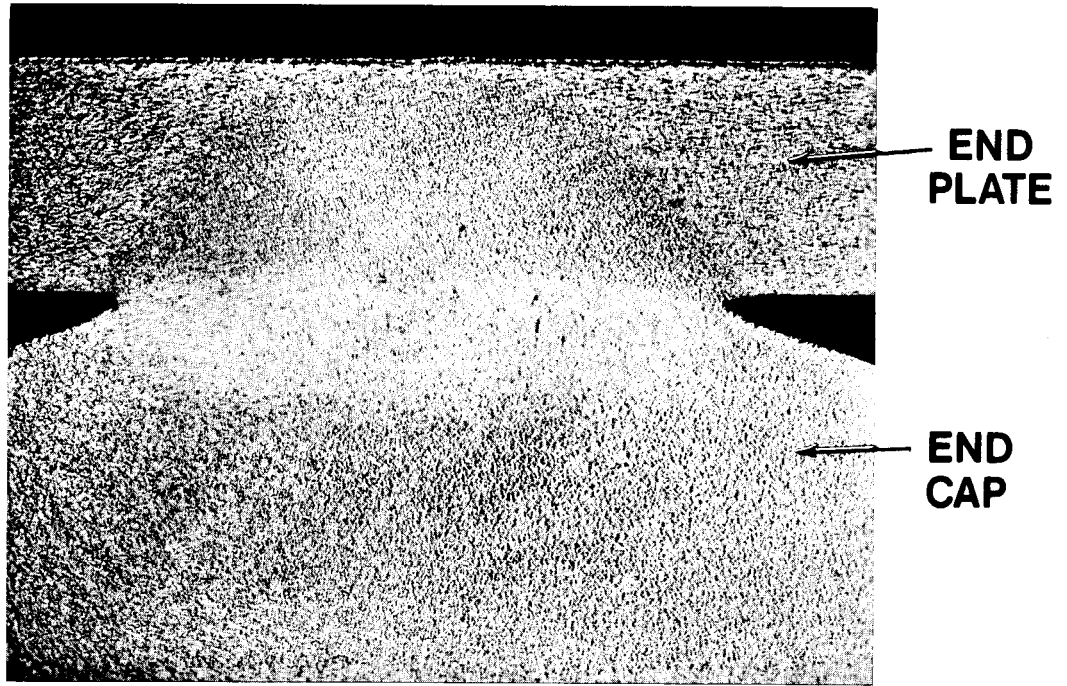

Figure 9 Cross Section of End Plate Assembly Weld

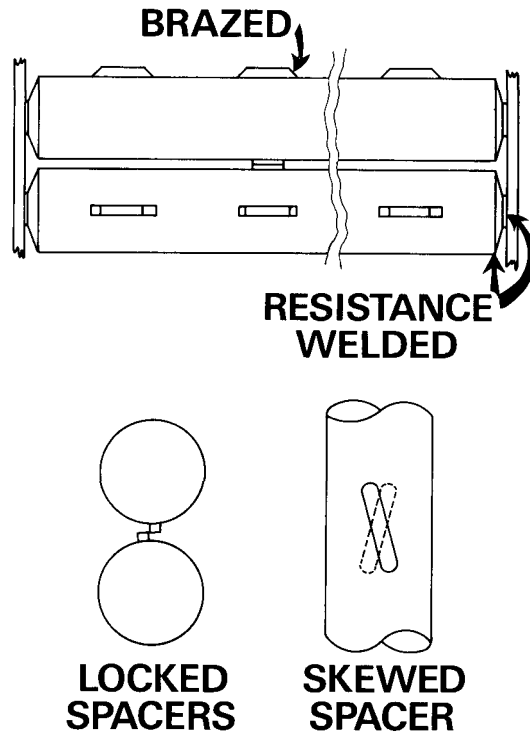

Figure 10 Split Spacer Design

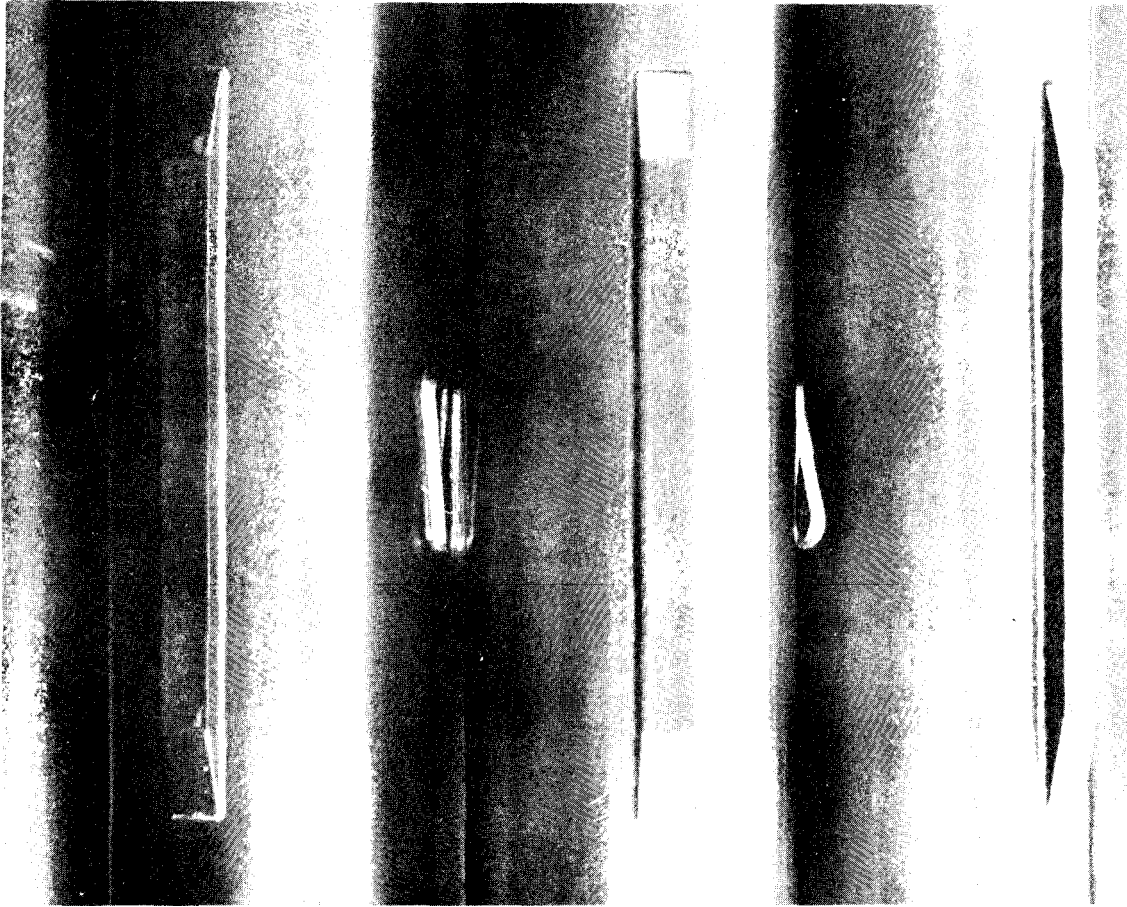

Figure 11 Close-up of Brazed Split Spacer and Bearing Pads

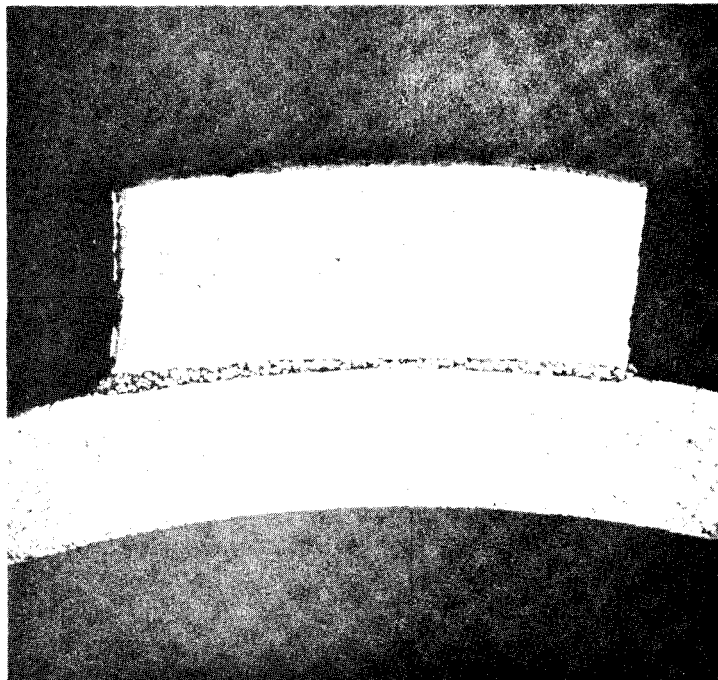

Figure 12 Cross Section of Brazed Spacer

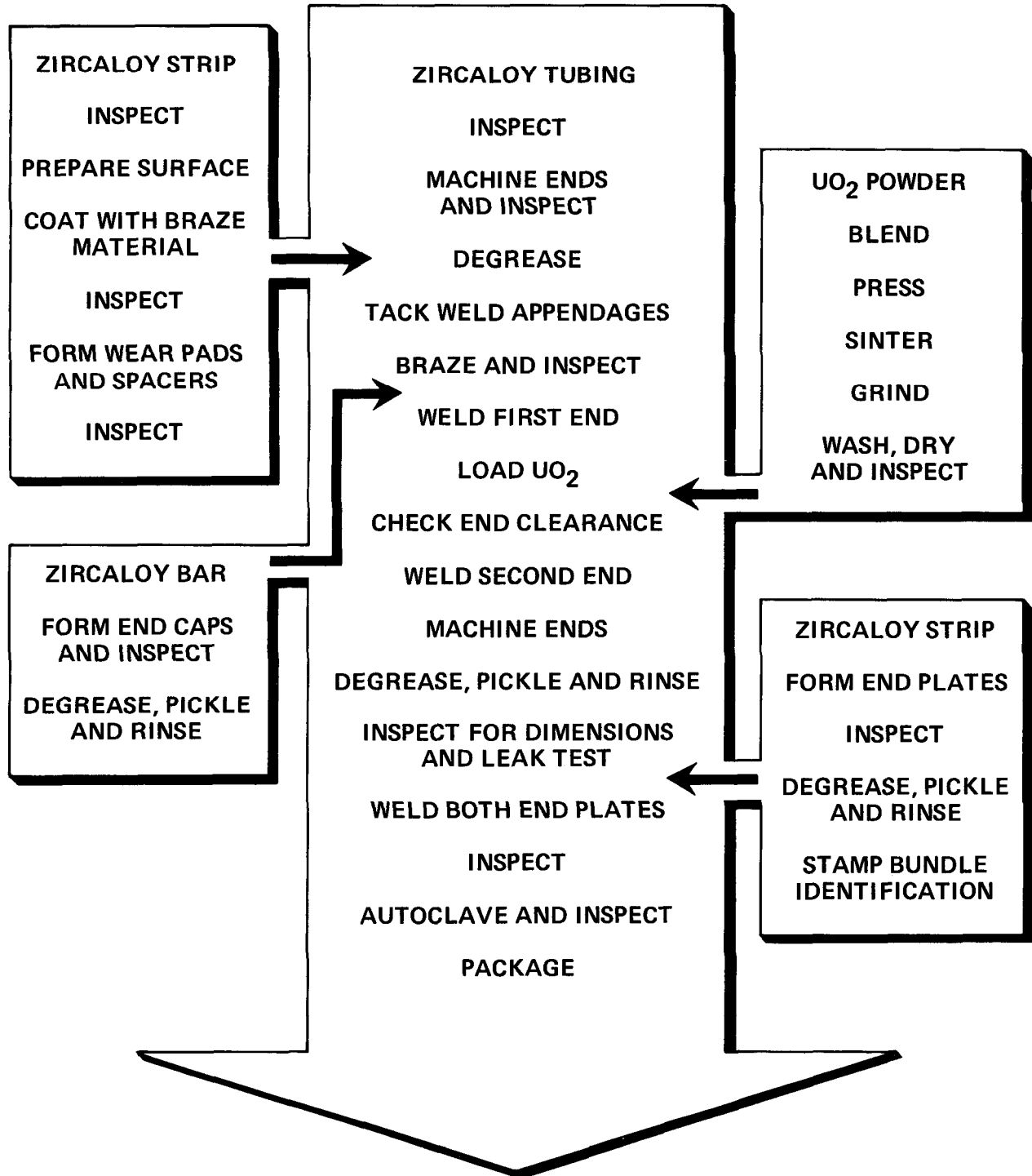

Figure 13 Split-Spacer Bundle Manufacturing Steps

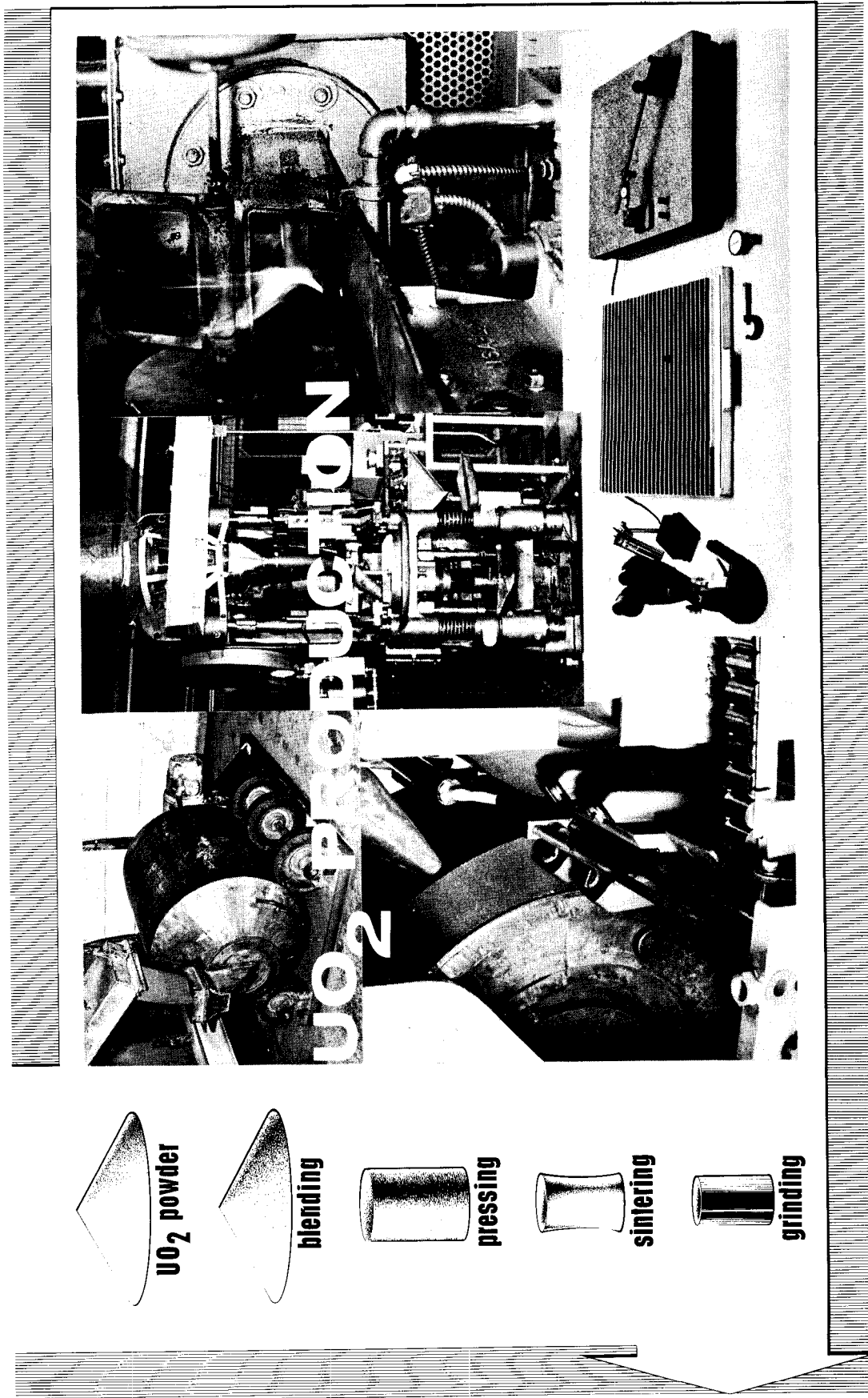

Figure 14 UO₂ Production



Figure 15 Fuel Bundle Production, Stage 1

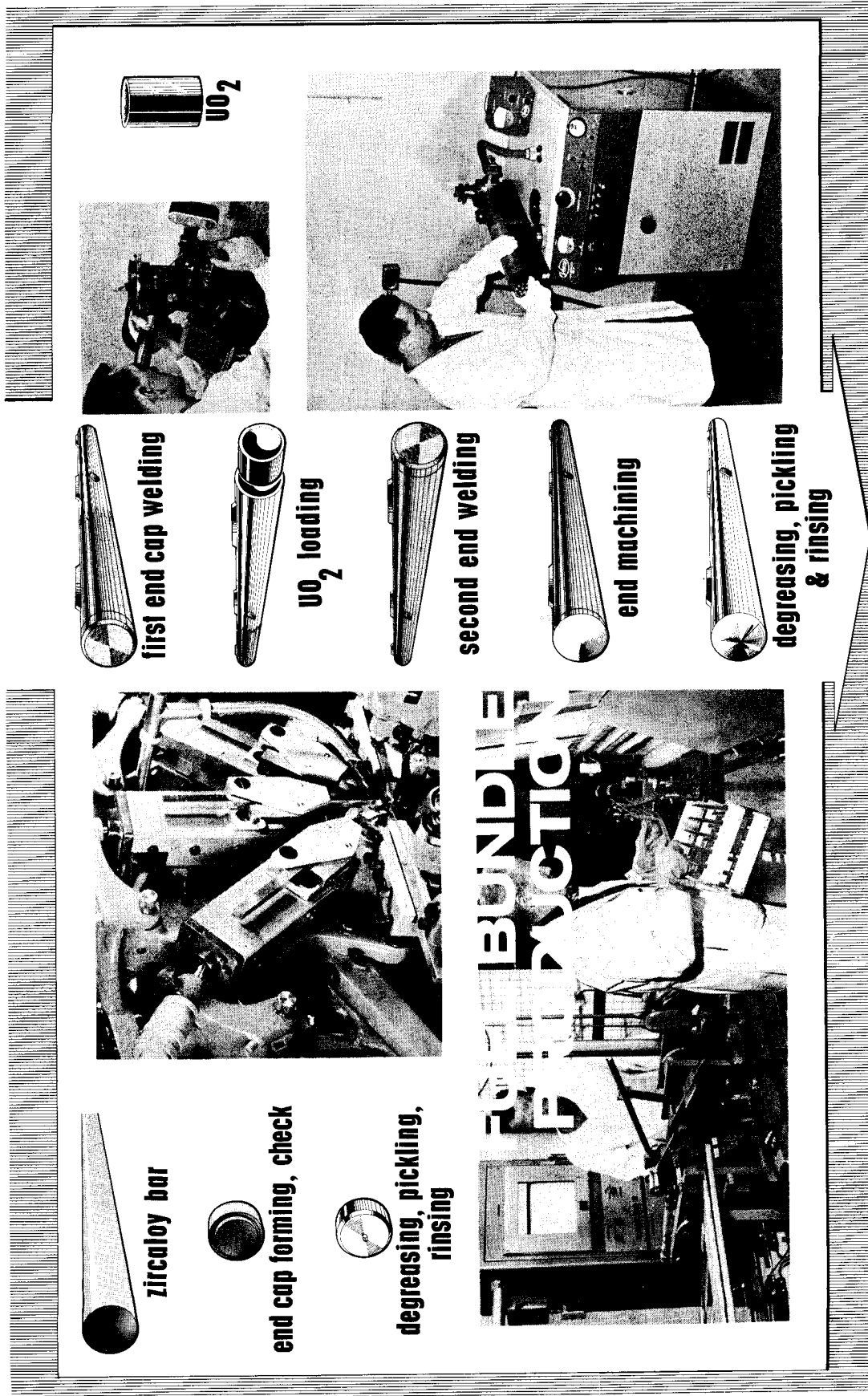

Figure 16 Fuel Bundle Production, Stage 2

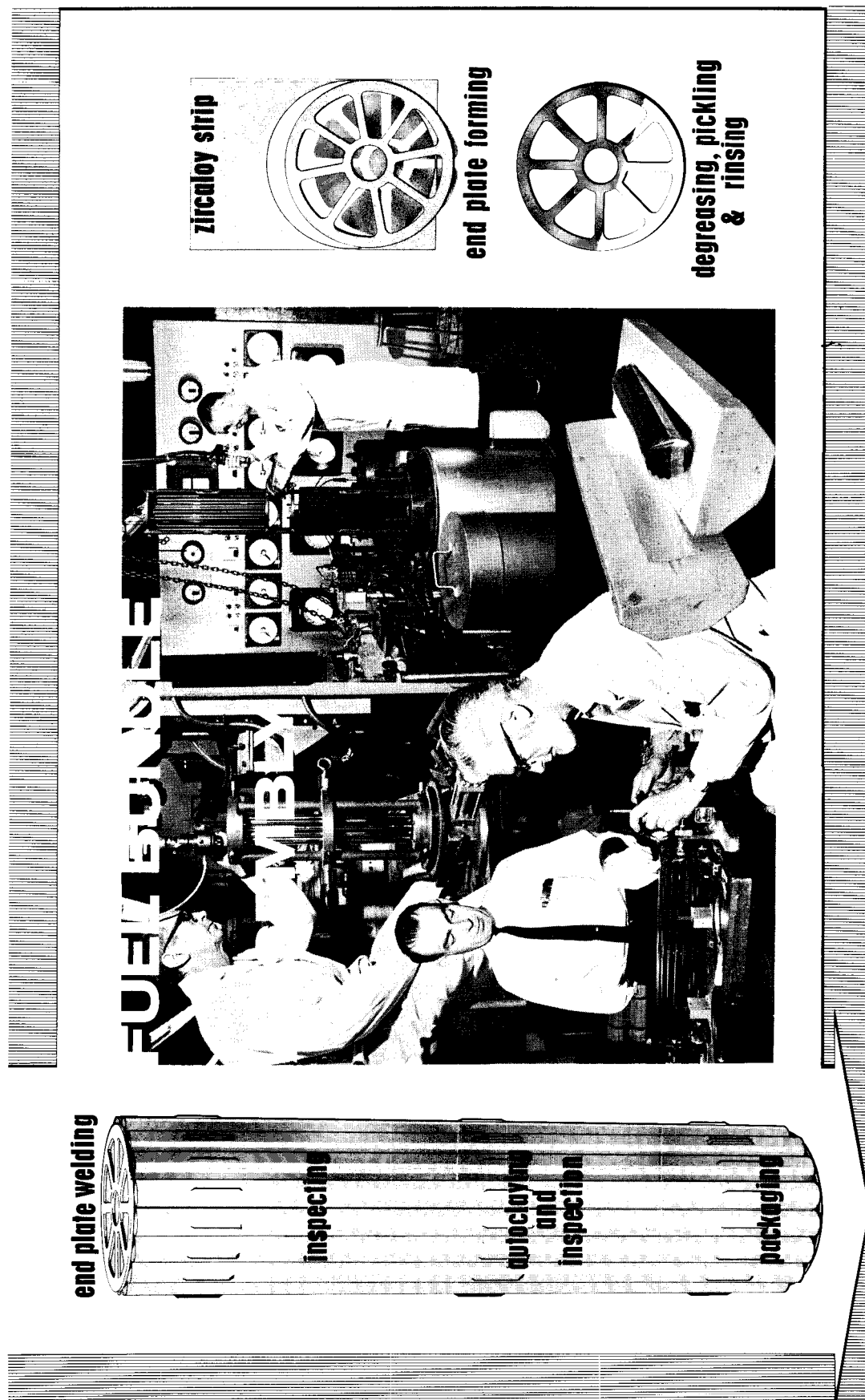

Figure 17 Fuel Bundle Assembly

6. FISSILE, STRUCTURAL MATERIALS AND COOLANTS

The various fissile, structural materials and coolants that are being used or developed for Canada's power reactor program are listed in Table III.

Table III Fissile, Structural Materials and Coolants

Fissile Material	Structural Materials	Coolants	Reactors
<u>Test Reactors</u>			
U, UO ₂ , U-Al	Al	H ₂ O	NRX
U, U-Al	Al	D ₂ O	NRU
UO ₂ , UC	Zr-2½ wt % Nb	Organic	WR-1
<u>Power Reactors</u>			
UO ₂	Zircaloy-2 and 4	D ₂ O-Liquid D ₂ O-Boiling H ₂ O-Boiling	PHW BHW BLW
<u>Booster Rods for Power Reactors</u>			
U-Al	Al	D ₂ O	Gentilly
U-Zr	Zircaloy	D ₂ O	NPD, Douglas Point & Bruce
<u>Materials in Development</u>			
U-Si-Al	Zr-2½ wt % Nb	H ₂ O-Boiling	Future Reactors
UC		and	
PuO ₂ -UO ₂	Zr-1.0 wt% Cr-0.1 wt% Fe	Organic	
PuO ₂ -Coated Particles in Graphite			
ThO ₂ -UO ₂			

6.1 Fissile Materials

Uranium metal was the original fuel for NRX and NRU research reactors. The fuel was formed into full length round rods or flat plates, clad in aluminum. The reactors at present are fuelled with enriched uranium aluminum alloy fuel, clad in aluminum. This type of fuel allows the reactors to operate at higher neutron fluxes at lower powers and operating costs.

U-metal has poor dimensional stability under irradiation and very poor corrosion resistance in high temperature water necessary to produce power. Therefore, all CANDU reactors to date have used natural UO₂ with either heavy- or light-water coolants. Satisfactory

behaviour of UO_2 for organic-cooled reactors also has been demonstrated, but the less corrosive coolant allows the use of UC with its higher uranium density. For water-cooled power reactors the corrosion rates of UC are far too high, and the only acceptable fuel materials with uranium densities higher than that of UO_2 are based on uranium-silicon. The binary alloy U_3Si provides adequate corrosion resistance while ternary uranium-silicon-aluminum alloys have been developed with aqueous corrosion rates at 550°C , one-thousandth that of U_3Si . Dimensional stability of the Zircaloy sheathed fuel element is satisfactory to at least 17 MWd/kgU if a void is provided during fabrication. Even with the void, the fuel still has the advantage of about a 30% net increase in uranium density over UO_2 . The uranium-silicon fuels have been prepared by extrusion and casting techniques which eliminate the need for handling many individual pellets. For this reason and because the costs of sheathing, assembly and inspection are shared over 30% more uranium, the cost ($\$/\text{kgU}$) of the finished bundle should be substantially lower than for UO_2 .

The fuel material for the bundles can be selected to accommodate a changing economic situation. Thus it is expected that plutonium recycling will be economically attractive before the end of this decade and that thorium-based fuels will be used later. Fabrication and irradiation of $\text{UO}_2\text{-PuO}_2$ and $\text{ThO}_2\text{-UO}_2$ have revealed no unexpected difficulties, and demonstration bundles of $\text{UO}_2\text{-PuO}_2$ are now being prepared for irradiation in the NPD reactor.

6.2 Structural Material

The basic structural material used in the construction of fuel assemblies is Zircaloy-2 or -4. This is an alloy of zirconium originally developed by the Americans for their naval reactor program, because of its low thermal neutron cross section and its good corrosion in 300°C water.

Table IV indicates the alloying elements of Zircaloy-2 and -4.

The significant difference between Zircaloy-2 and Zircaloy-4 is the deletion of nickel and the slight increase in iron in Zircaloy-4.

All Canadian power reactor fuels in production today use Zircaloy-4. It has a slight corrosion and hydrogen pick-up performance advantage over Zircaloy-2 under our coolant conditions, and is produced in larger volumes than Zircaloy-2.

Table IV Composition of Zircaloy-2 & 4

	Zircaloy-2	Zircaloy-4
Tin	1.20 - 1.70 wt%	1.20 - 1.70 wt%
Iron	0.07 - 0.20 wt%	0.18 - 0.24 wt%
Chromium	0.05 - 0.15 wt%	0.07 - 0.13 wt%
Nickel	0.03 - 0.08 wt%	-
Total Fe + Cr + Ni	0.18 - 0.38 wt%	0.28 - 0.37 wt%
Carbon	150 - 400 ppm	150 - 400 ppm
Oxygen	900 - 1400 ppm	900 - 1400 ppm
Zr + Permitted Impurities	Balance	Balance

In future CANDU boiling-light-water reactors, increasing the channel power will increase the exit quality of the coolant with the result that local overpower transients could cause dry-out of the sheath with its temperature rising to 500°C. To withstand these excursions requires better sheath alloys that will not absorb significantly more neutrons. Experimental UO₂ fuel elements with sheaths of Zr-2.5 wt% Nb and Zr-1 wt% Cr-0.1 wt% Fe have survived an irradiation of 173 days in steam with estimated sheath temperatures up to 500°C.

Graphite and silicon-carbide have been investigated for future long-term use in superheated steam.

6.3 Coolants

The predominant coolant in Canada's program has been pressurized heavy water (PHW) and is used in NPD, Douglas Point, Pickering and Bruce. Boiling heavy water (BHW) has been used in NPD, when it was converted to this mode of operation for two years as an experiment.

The outer zone of the Bruce core has low net exit quality 3% and future reactors will have increasing qualities at exit from the channel, as the power density is increased with a constant inlet coolant temperature.

The Gentilly reactor uses normal light water as a coolant and the reactor is designed to boil the water in the reactor (BLW). The average exit quality for the core is 16.5 wt% steam.

Because organic coolants can be operated at higher temperatures than water while at lower pressures, they are being developed for future reactors. WR-1 test reactor at Whiteshell, Manitoba, is cooled by this fluid (HB-40). This higher temperature of the coolant will allow higher overall station thermal efficiency. A comparable station would discharge about a third less heat in its cooling water than a PHW per unit of energy generated.

Liquid metals and molten salt coolants were investigated for a short time for future use but these studies have been discontinued so we can concentrate our limited effort on boiling water and organics.

7. FUEL PERFORMANCE AND MATERIAL BEHAVIOUR

7.1 Uranium Dioxide

7.1.1 Thermal Expansion

UO₂ is a ceramic and has a relative low thermal conductivity which varies with temperature. When operating in a reactor at power, it has a high centre temperature with respect to its surface temperature. The centre temperature is proportional to both the diameter of the element and the power rating. The term $\int_{\theta_s}^{\theta_c} \lambda d\theta$ is often used as a reference of UO₂ ratings⁽¹⁾ and represents the integrated thermal conductivity of the UO₂ from the temperature at the surface to the centre of the pellet. When UO₂ is operated at temperatures above ~1400°C, grain growth occurs. This condition is shown in Figure 18 for various ratings and centre temperatures. The extent of the grain growth increases with temperature.

Due to the low strength of the UO₂ in tension, the pellets crack during expansion and contraction from temperature changes. At temperatures above 800-1400°C, UO₂ becomes plastic and will creep and flow into voidage provided to accommodate the volumetric thermal expansion.

(1) For round rods the power per unit length is given by $4\pi f_1 \int_{\theta_s}^{\theta_c} \lambda d\theta$

where $f_1 = 1$ for solid rods with uniform power density.

Therefore $\int_{\theta_s}^{\theta_c} \lambda d\theta = \frac{q}{4\pi} f_1$ where θ_s is the temperature at surface of the UO₂ and θ_c is temperature of the UO₂ at the centre.



7.5X

V35A3

CENTRAL TEMPERATURE < 1500 °C

$$\int \lambda d\theta = 30 \text{ W/cm}$$



7.5X

R52AI

CENTRAL TEMPERATURE 1600 - 1700 °C

$$\int \lambda d\theta = 40 \text{ W/cm}$$



7.5X

R58BI

CENTRAL TEMPERATURE 2400 - 2600 °C

$$\int \lambda d\theta = 55 \text{ W/cm}$$



7.5X

V47H3

CENTRAL TEMPERATURE > 2800 °C

$$\int \lambda d\theta \geq 75 \text{ W/cm}$$

Figure 18 Typical Transverse Cross Section of Irradiated UO₂ at Four Power Ratings

7.1.2 Radiation-Induced Swelling

It has been found under certain conditions that the swelling rate of irradiated UO_2 at relatively low temperatures is 0.7% change in volume per 10^{20} fission/cm³ (2% per 10,000 MWd/TeU). Of this, perhaps half is due to solid fission products and the remainder due to the formation of gas filled bubbles within the fuel. At high power outputs, however, a significant volume of the fuel is so hot that it retains very little gas. At intermediate temperatures (800-1400°C) fuel plasticity and gas mobility are appreciable while gas release is low, which might cause the swelling rate to reach a maximum.

Swelling can be accommodated in porosity in the fuel. Below about 1400°C porosity is probably not greatly reduced by fuel thermal expansion, so may still be available to accommodate swelling. Since current production fuels are less than 98% dense there should be no problems with swelling up to burnup of 240 MWh/kgU (10,000 MWd/TeU). In practice, during the latter part of its lifetime, Canadian power reactor fuel operates at a power output lower than its previous maximum and the shrinkage cracks that are formed are available to accommodate some further swelling. For these reasons we do not envisage any swelling limitations with fuel elements made from natural UO_2 .

7.1.3 Gas Release

UO_2 releases a percentage of the fission gases that are produced as a natural product of fissioning. The higher the rating or central temperatures the greater is the amount of gas released inside the elements, therefore space has to be provided to prevent the gas causing excessive pressures at high ratings.

The shape of gas release curve is shown in Figure 19, which is the plot of our experimental measurements of percentage gas release Vs ratings. The percentage release increases quite rapidly with higher ratings above 40 W/cm.

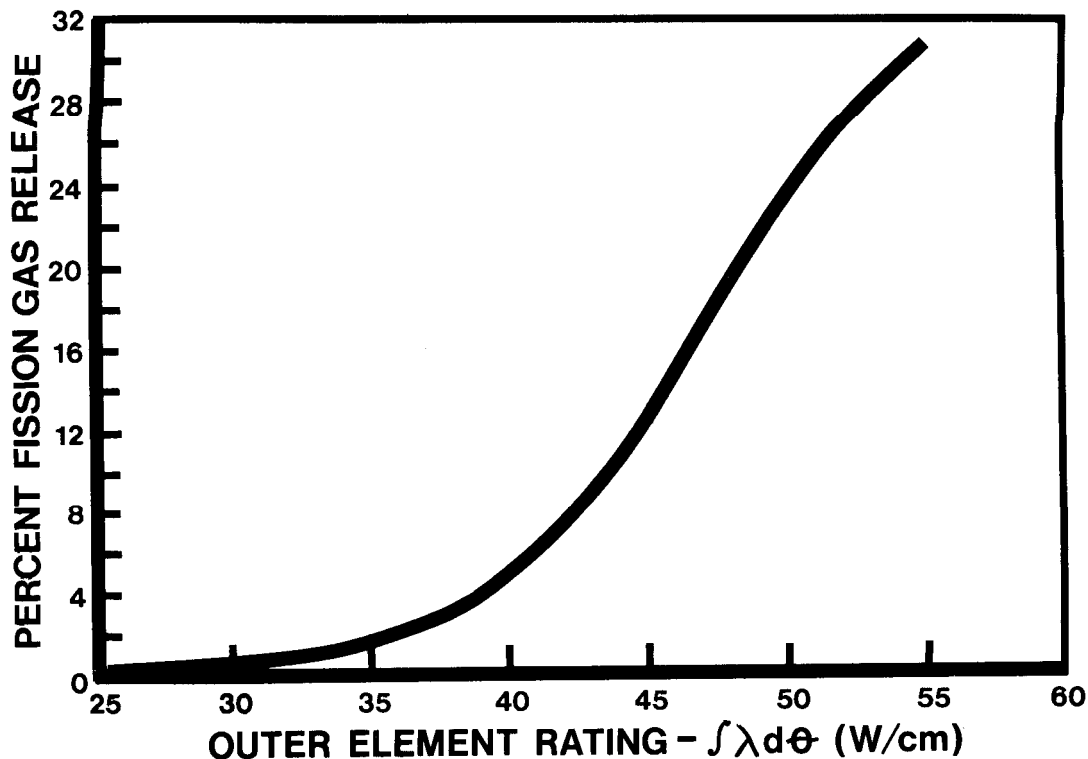

Figure 19 Percent Fission Gas Release vs UO₂ Power Rating

7.2 Zircaloy

Zircaloy is affected during its life by irradiation damage, corrosion, H₂ or D₂ pickup and internal corrosion.

7.2.1 Irradiation or Fast Neutron Damage

Both cold work and fast neutron damage ($E > 1$ MeV) will reduce the ductility of zirconium alloys as shown in Figure 20 where the ductility, in the form of total circumferential elongation at 300°C is expressed as a function of the axial ultimate tensile stress. Indeed the sheathing of some early Douglas Point fuel showed negligible ductility after a fast neutron exposure of 3×10^{20} n/cm² ($E > 1$ MeV). Now heat treatments are specified to retain, on average, a 20% total circumferential elongation at 300°C even after an irradiation of 3×10^{20} n/cm².

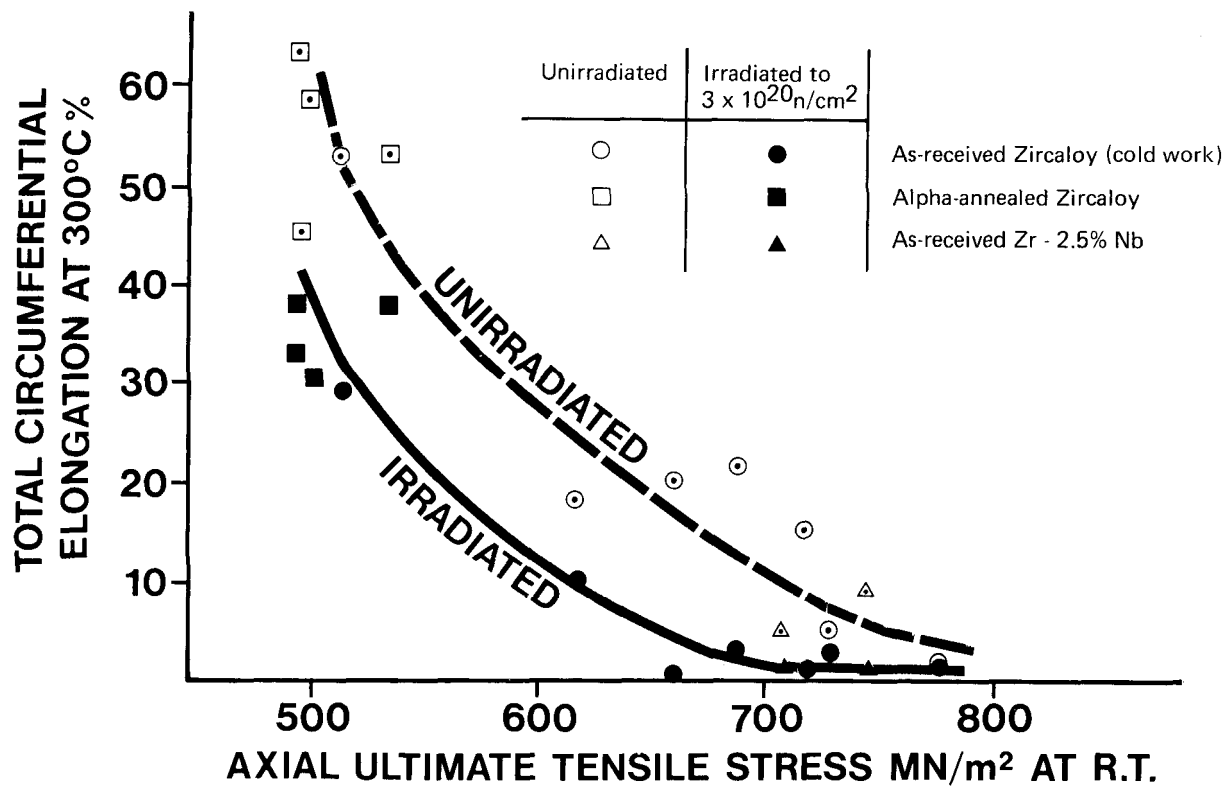

Figure 20 Effect of Cold Work and Irradiation on the Total Circumferential Elongation in Zirconium Alloys

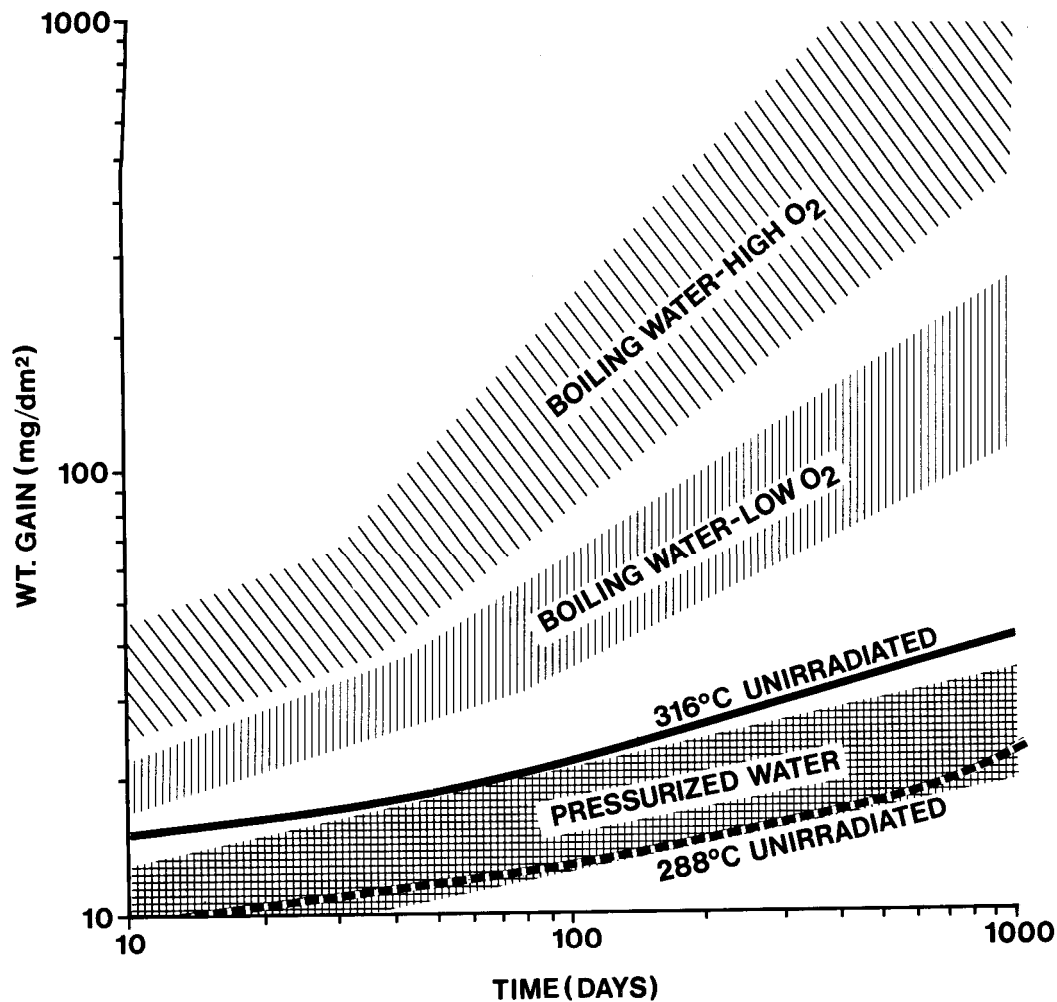

Figure 21 Effect of Oxygen on the In-Reactor
Corrosion of Zircaloy, 270-300°C

7.2.2 Corrosion and Hydrogen Pick-Up

The in-reactor corrosion of Zircaloy varies with time, temperature and coolant chemistry. Figure 21 indicates rate of corrosion with time in three different types of coolants in the temperature range 270-300°C. The loss of metal from corrosion is not a major concern during the normal fuel life provided that the coolant chemistry is well controlled. In a boiling water reactor the corrosion rate is slightly higher.

Zircaloy has a marked affinity for H_2 and D_2 , which makes it less ductile at low temperatures, and both the internal atmosphere of the element and the external chemistry of the coolant must be controlled to prevent excessive H_2 or D_2 accumulating in the Zircaloy. If the fuel is built with some moisture inside the elements, the resultant H_2 produces what we call Zr hydride, see Figure 22. Zr hydride will cause a fuel failure, therefore we have taken steps to ensure a very low content of internal H_2 in our elements.

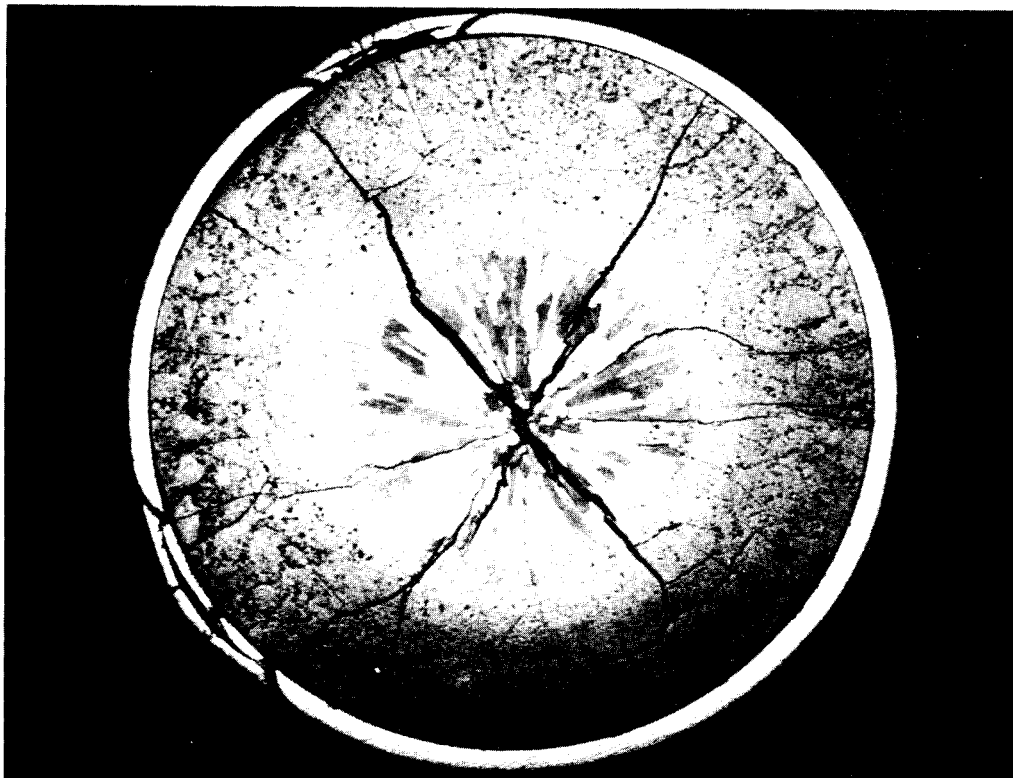

Figure 22 Cross-Section of Fuel Element Showing Zr Hydride

The change in the D_2 concentration in Zircaloy-2 fuel sheathing with time for different coolant chemistries in NPD is shown in Figure 23, which indicates that with

- high D_2 gas in the coolant the oxidation of Zircaloy cladding is similar to that observed out-reactor, but D_2 pick-up by the cladding is considerably greater than that expected from corrosion alone.
- low D_2 gas in the coolant the oxidation of Zircaloy cladding is greater than that observed out-reactor but the D_2 pick-up is low.

Acceptable coolant chemistry conditions to meet the requirements of all the primary circuit material, can be specified for all types of coolant PHW, BHW or BLW.

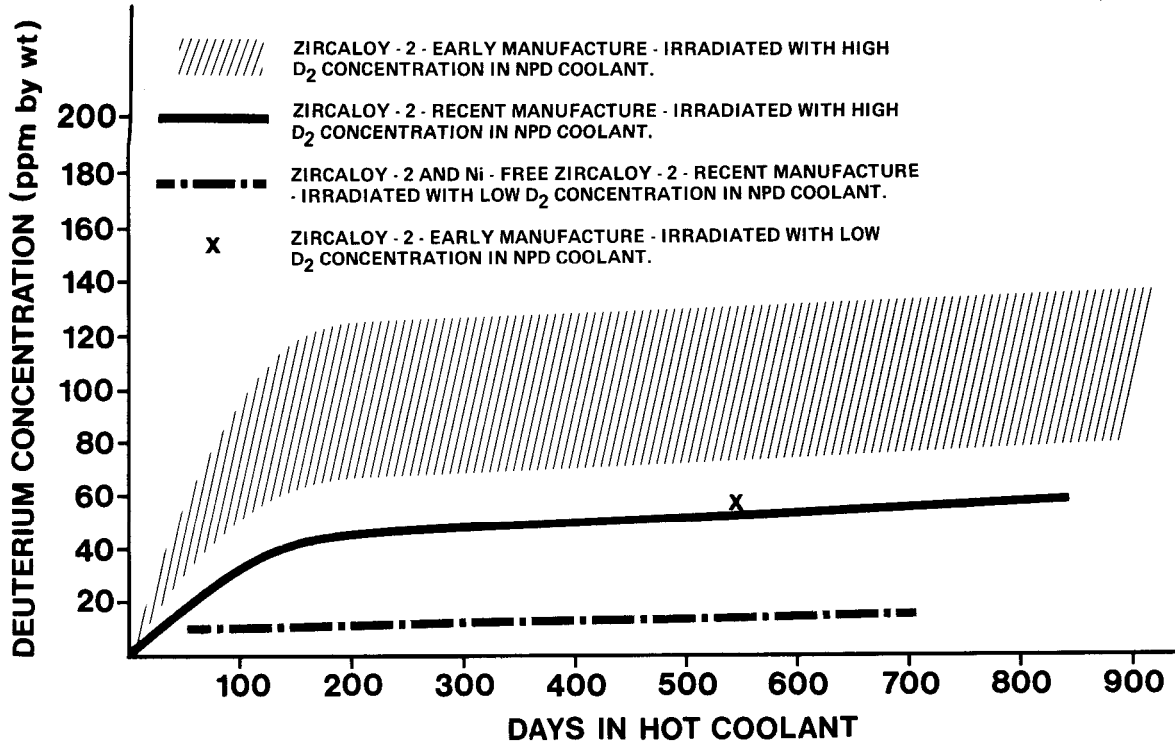

Figure 23 Deuterium Pick-up of NPD Sheathing

7.3 Fuel Element

A fuel element is the basic component of a fuel bundle. In other countries they are sometimes referred to as pencils or rods.

The fuel element has to be designed to withstand the following conditions: creep collapse in the high pressure coolant, accommodate the thermal expansion of the UO_2 , without causing any blockage of the coolant, contain the internal fission products and gases, the external hydraulic and fuelling machine forces.

7.3.1 Sheath Collapse

Fuel sheathing, depending on wall thickness, will creep down under irradiation unless supported by the UO_2 pellets. In thin wall elements, primary collapse or wrinkling of the sheath is prevented by controlling the diametral gap between pellet and sheath to small values, and by ensuring that the specified wall thickness and mechanical properties are maintained.

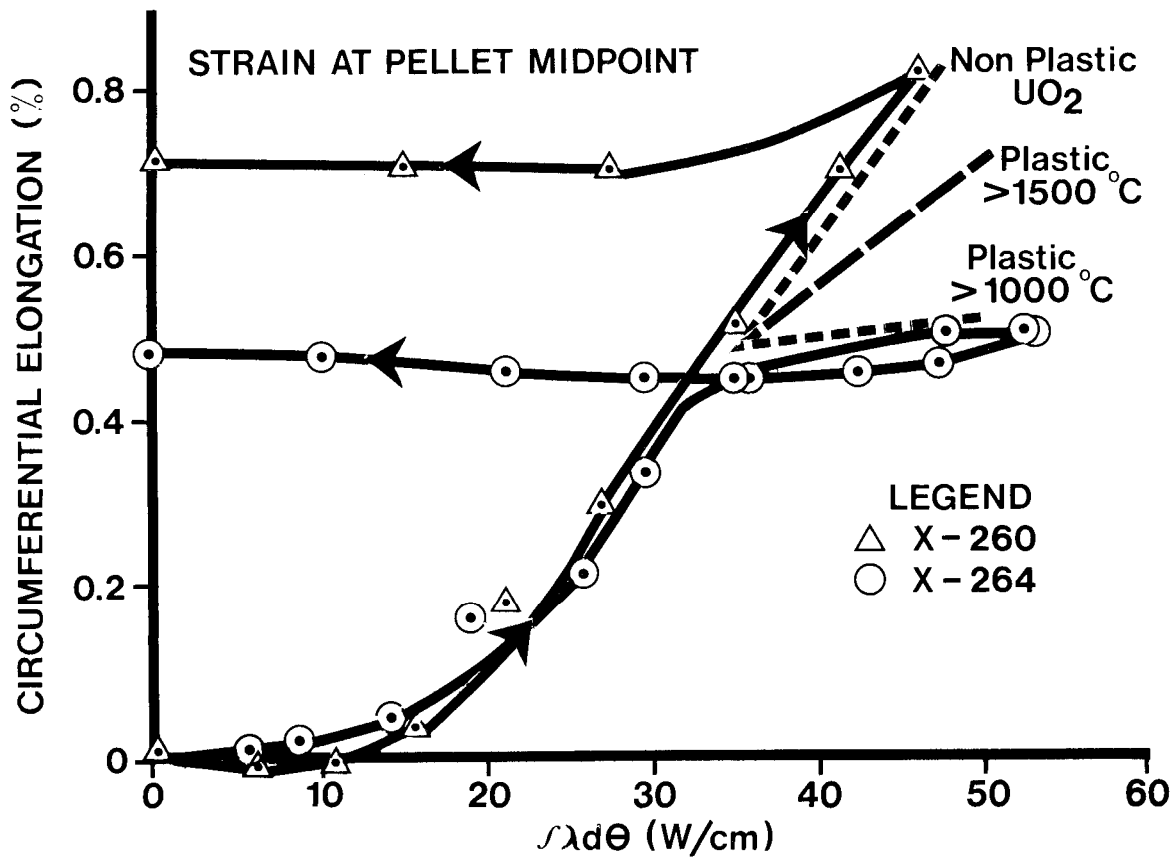
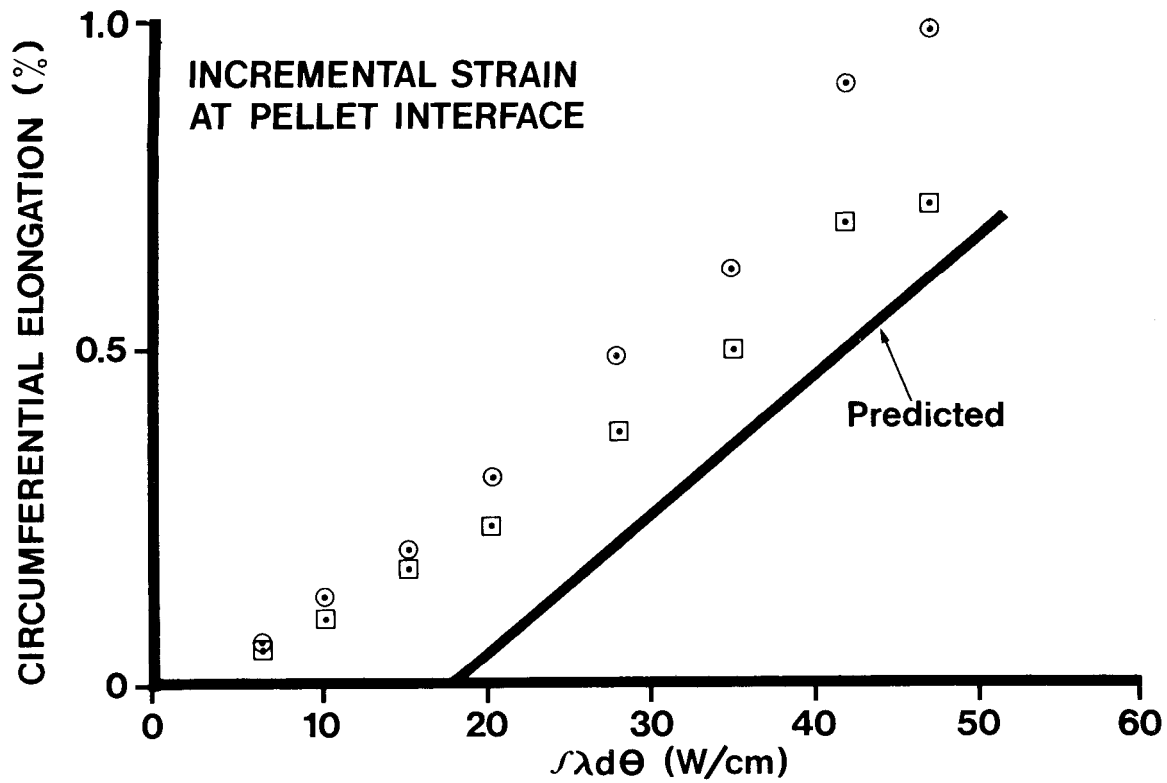

Figure 24 Circumferential Strains Measured With Resistance Strain Gauges During the First Power Cycle (two different tests), Compared with Calculated Expansions

7.3.2 Element Thermal Expansion

The deformability of UO_2 pellets has recently been evaluated by using resistance strain gauges to measure the circumferential expansion of the sheath as a function of power. The effects of start-up rates on fuel expansion and the strain (fatigue) cycle to be expected in a load-following reactor have been investigated. The results obtained in two separate experiments are shown in Figure 24. For the first cycle from zero to full power and back to zero power they agreed well with each other and with the values calculated from simple physical models: however, while the two batches of UO_2 were thought to be identical, one seemed to deform plastically above 1000°C while the other showed non-plastic behaviour up to the maximum temperature of about 1800°C .

At each pellet interface a circumferential ridge is formed in the sheath, producing a "bamboo effect" which is visible on high rated fuel. The top graph of Figure 24 indicates the local circumferential strain that occurred at this interface and the predicted value. The sum of this and the strain at the pellet midpoint gives the maximum local strain of the sheath.

Figure 24 also shows that the sheath recovers very little of its strain as the power is reduced. During subsequent power cycles the recovery is even less, and after an irradiation of about ten days, a return to zero power causes a $\sim 0.1\%$ change in sheath circumference. Such small changes in average sheath strain could partly result from strain localization.

The interrelationships between fuel expansion, the pressures caused by fission-product-gas release and the fuel-to-sheath heat-transfer coefficient are complex. The fuel-to-sheath heat-transfer coefficient decreases as the internal gas pressure increases, and this effect causes one of the major uncertainties for predicting fuel behaviour. So, for the design of power-reactor fuels, we impose the condition that the maximum internal gas pressure should not cause significant sheath strain. This necessitates including a small gas plenum in some fuel designs.

If the design criterion is to operate with gas pressures in excess of coolant pressure and accept a small amount of sheath strain (creep) due to gas pressure, then the situation is very much more complex. The inter-relationships between various operating parameters are outlined below, using the convention that $A \rightarrow B$ means that a change in A affects B. The complex relationship requires a computer program which is available to predict the behaviour.

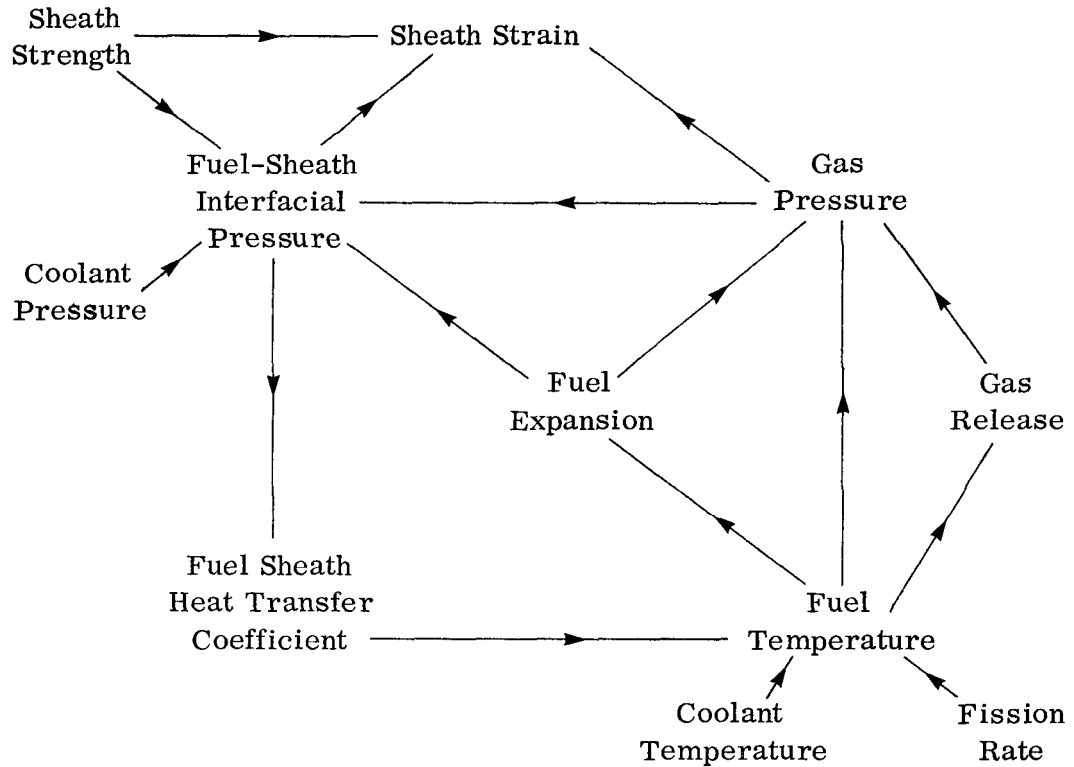

7.3.3 Hydraulic and Fuelling Machine Loads

These loads are supported by the column strength of the fuel element which are affected by the diameter, wall thickness and mechanical properties of the element tubing. It has been found by both out-reactor and irradiated bundle testing that the fuel elements have strength requirements in excess of hydraulic and fuelling machine load requirements.

7.4 Fuel Handling System

All Canadian power reactors are designed for on-power fuelling. The system is basically similar for all reactors but the machines and systems for Douglas Point, RAPP¹, Pickering and the proposed 600 MWe PHW reactors differ in detail from those for NPD, KANUPP² and Bruce.

A flow diagram of the overall fuel handling system showing the various steps from new fuel into the reactor to spent fuel discharged to the storage bay is shown in Figure 25 for Pickering and in Figure 26 for a proposed 600 MWe reactor.

¹ "RAPP" Rajasthan Atomic Power Project

² "KANUPP" Karachi Nuclear Power Project

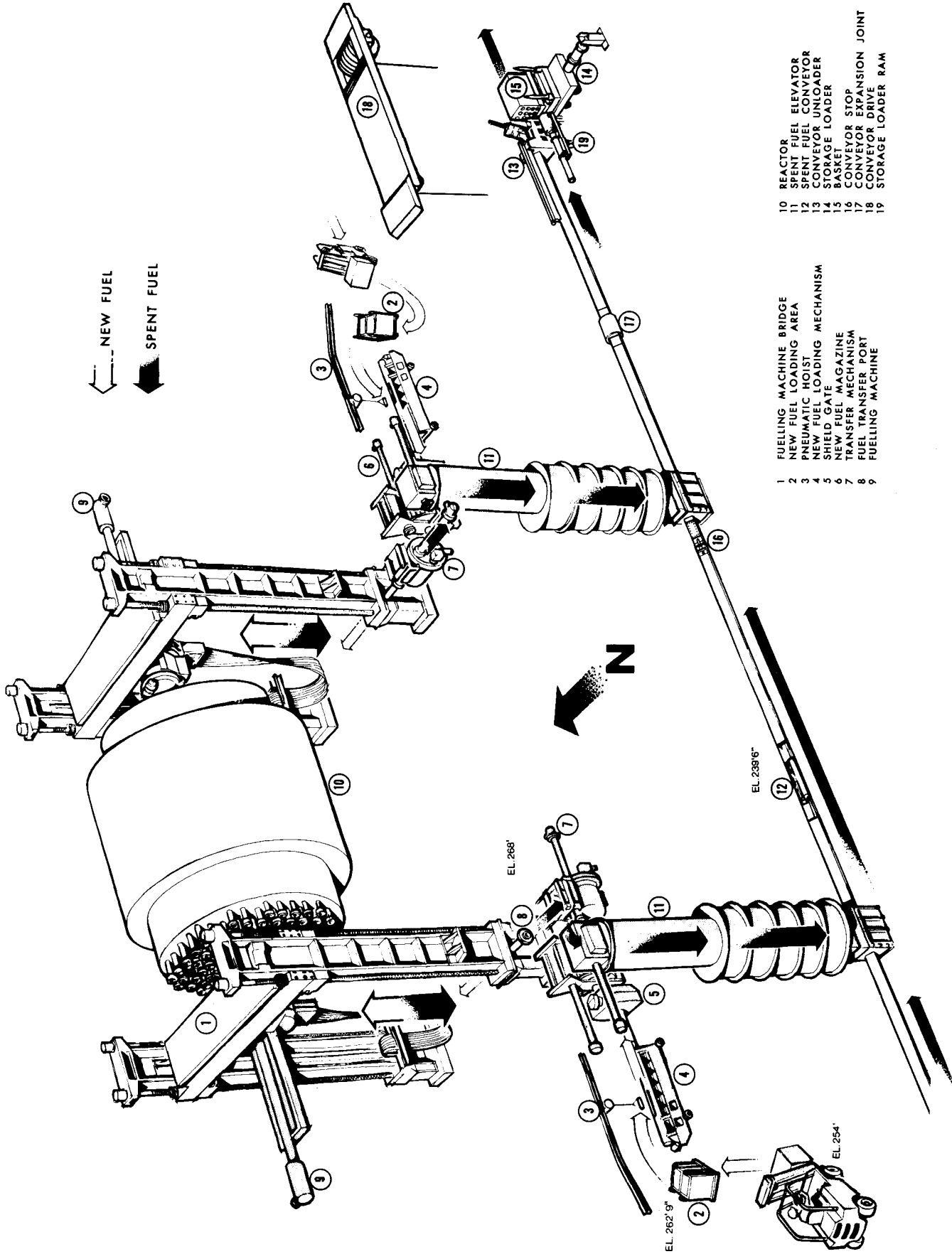

← NEW FUEL
 → SPENT FUEL

- 1 FUELLING MACHINE BRIDGE
- 2 NEW FUEL LOADING AREA
- 3 PNEUMATIC HOIST
- 4 NEW FUEL LOADING MECHANISM
- 5 STEEL GATE
- 6 NEW FUEL MAGAZINE
- 7 TRANSFER MECHANISM
- 8 FUEL TRANSFER PORT
- 9 FUELLING MACHINE
- 10 REACTOR
- 11 SPENT FUEL ELEVATOR
- 12 SPENT FUEL CONVEYOR
- 13 CONVEYOR UNLOADER
- 14 BASKET LOADER
- 15 CONVEYOR STOP
- 16 CONVEYOR EXPANSION JOINT
- 17 CONVEYOR DRIVE
- 18 STORAGE LOADER RAM
- 19

Figure 25 Pickering Fuel Handling System

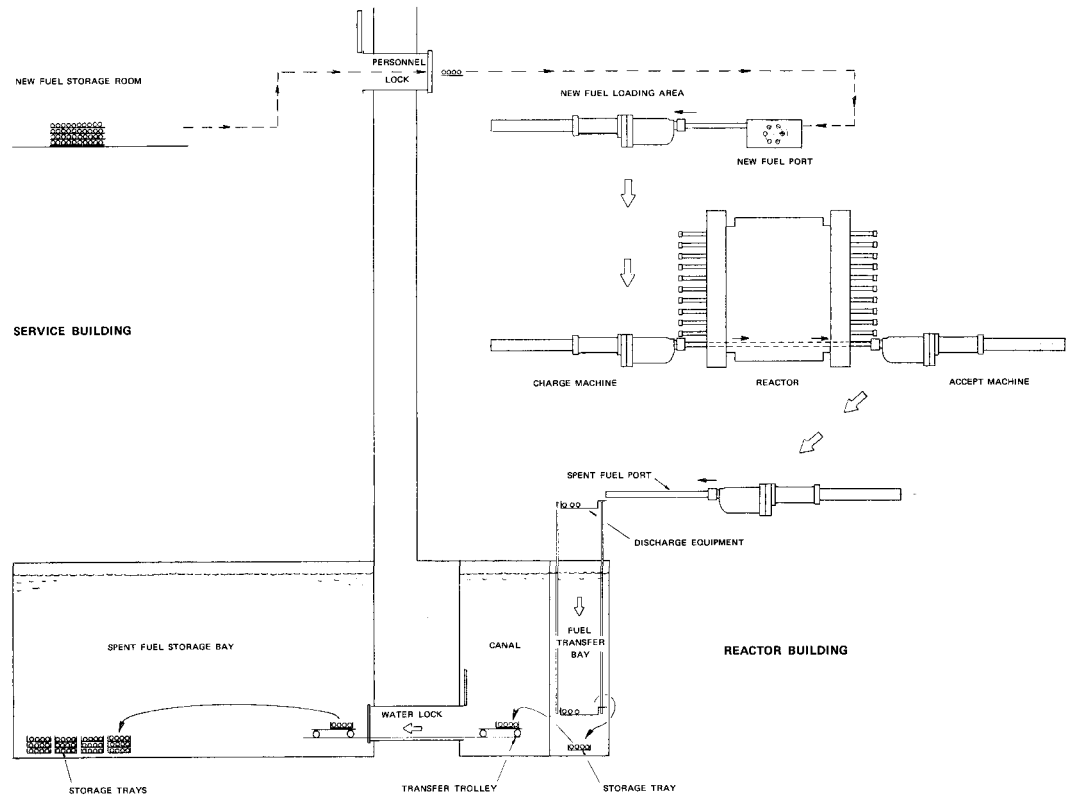

Figure 26 PHW-600 Fuel Handling Sequence

The fuelling operations for these stations begin with the semi-manual loading of new fuel bundles into the magazines through the two new fuel ports after which the ports' loading gates are sealed. Subsequent fuel changing sequences are all performed by remotely operated equipment behind heavy biological shielding with operator discretion on the degree of utilization of available, fully programmed automatic control. Two fuelling machine heads equipped with internal rams and magazines are connected and sealed to the new fuel ports, where one of the magazines is loaded with the required quota of new fuel bundles for the planned fuelling operation. The machines then move to opposite ends of one of the reactor's fuel channels. The heads are connected and sealed to the channel ends, topped up with reactor grade heavy water and pressurized to match channel coolant pressures. A leak check is then performed on the head-to-channel seal. The heads next remove and store the channel closure and shield plugs in their magazines. New fuel bundles are inserted into the channel by one of the heads with spent and/or partially spent bundles being received from the channel by the other. The heads then replace the channel shield and closure plugs and, after

depressurization followed by a leak check on the channel closure, disconnect from the ends of the channel. After visiting channels as programmed, for insertion of new bundles or repositioning of partially spent bundles, the machines move to and seal their heads to spent fuel ports. The spent fuel bundles are then discharged rapidly in air from the heavy water environment of the fuel changing equipment to the light water environment of the transfer equipment which carries them to the spent fuel bay. There they are stacked for long-term storage underwater in the bay using semi-manually operated remote handling equipment.

Photographs of the Douglas Point and Pickering fuelling machines are shown in Figures 27 and 28.

7.5 Fuel Bundle Testing

A fuel bundle has to meet the following major conditions:

- (1) Compatible with the reactor coolant system when producing the design power.
- (2) Compatible with the reactor fuel transfer and fuelling machine requirements for on-power fuelling.
- (3) Capable of surviving power changes due to fuelling, reactivity mechanism or reactor power cycles during its normal life in the reactor.

To ensure that the fuel bundle is compatible with the reactor coolant system and fuel transfer and fuelling machine requirements, all fuel bundle designs are given the following tests before they are committed to production.

7.5.1 Tests

- (1) Pressure drop - tests are done on a full channel of fuel bundles over a range of coolant flows and orientation in hot pressurized water.
- (2) Endurance tests - full channels of fuel bundles are run at maximum flow condition to many thousands of hours to ensure that they do not fret or mark the pressure tube. Also the wear of the spacer between elements is monitored to ensure that the design meets the lifetime requirements of the fuel in the reactor.

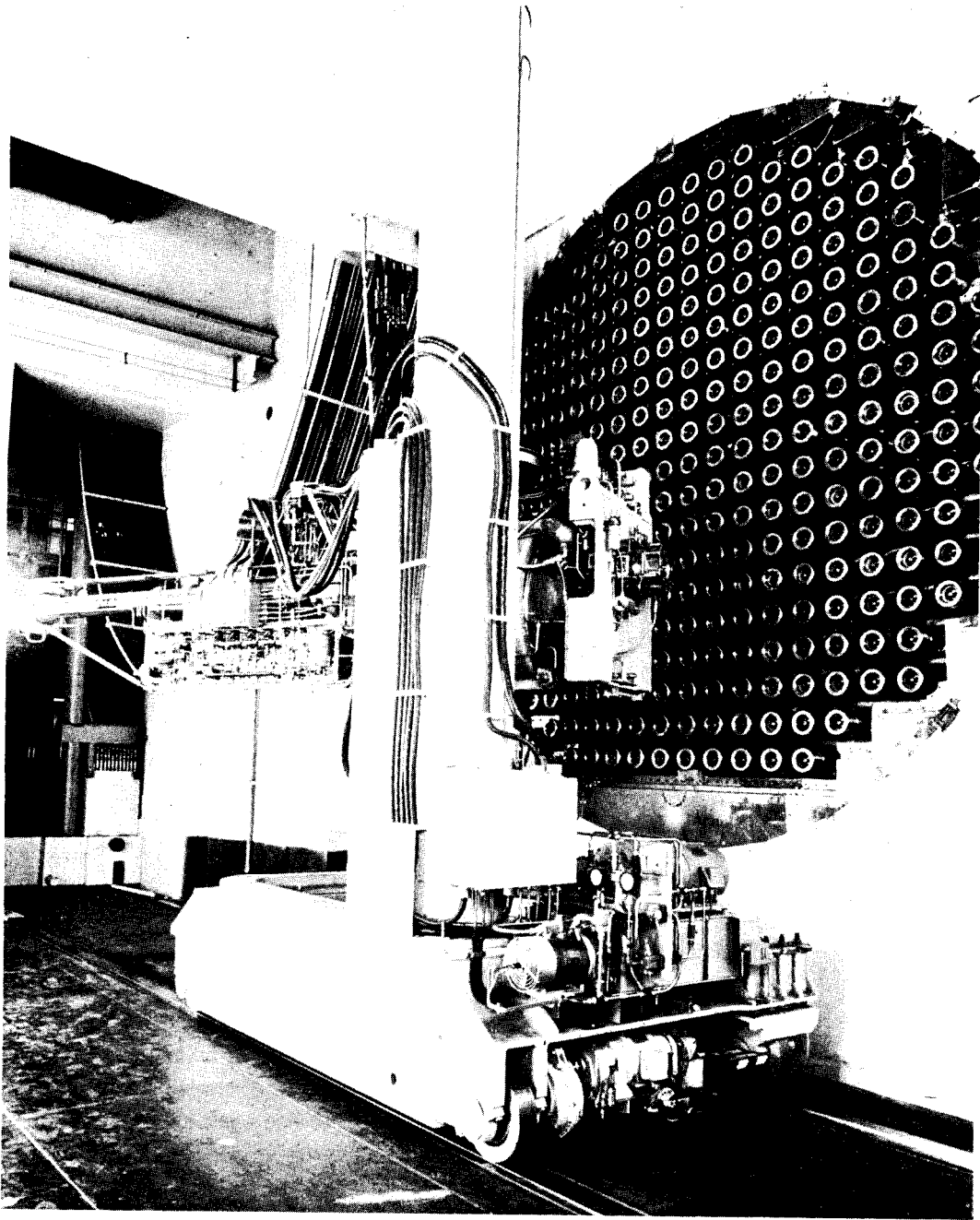

Figure 27 Douglas Point Fuelling Machine

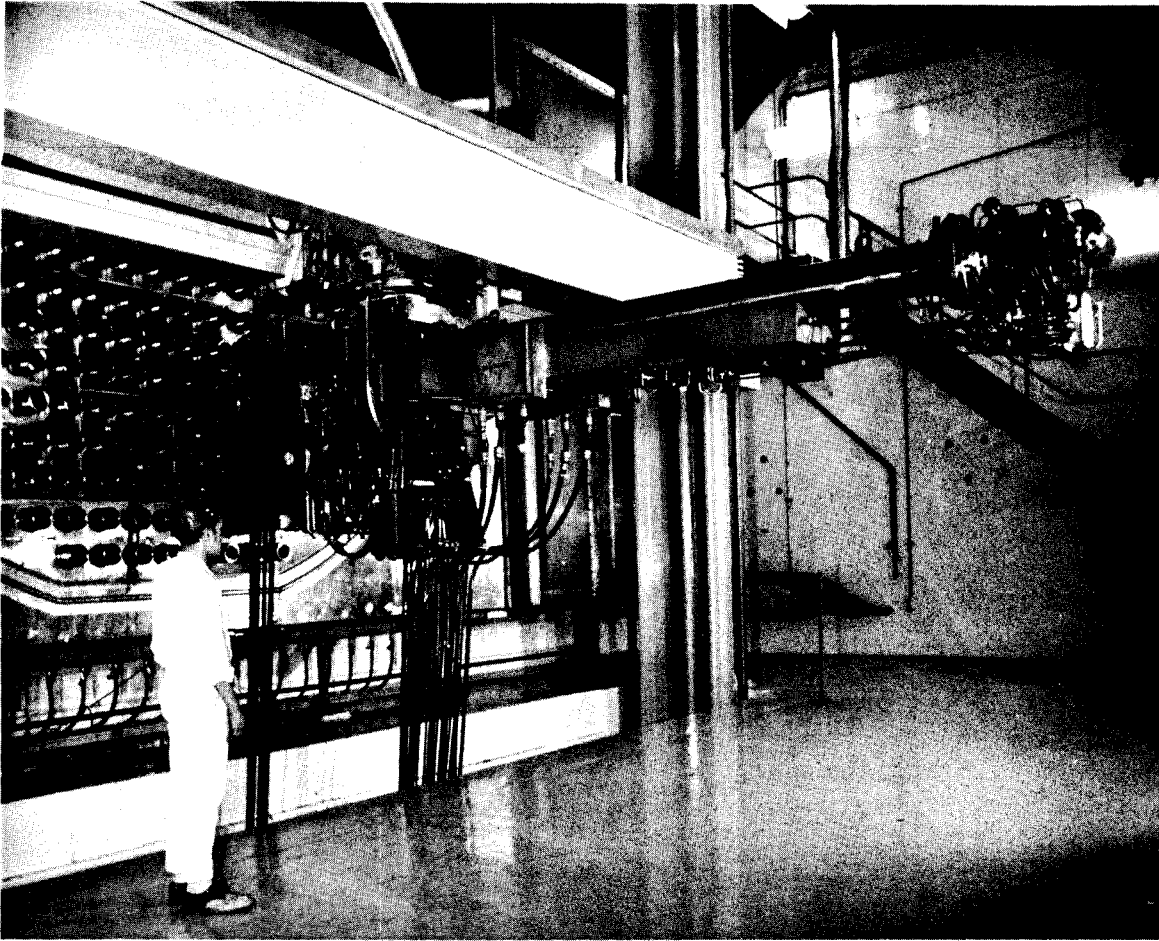

Figure 28 Pickering Fuelling Machine

- (3) Wear tests - the bundles are subjected to simulated wear tests to check that the bundles will not wear the pressure tube during its lifetime and the bearing pads do not lose more than the allowable amount during their passage through the reactor.
- (4) Strength tests - various strength tests are performed to ensure that the bundles can withstand the various loads imposed on them during on-power fuelling. It has been found that the bundles are very strong in compression when contained in the pressure tube.

7.5.2 Irradiation Testing

All fuel and structural materials are irradiated in AECL's test reactors, NRX, NRU, and WR-1. The final testing is done on full

scale power reactor fuel in the big loops in NRU before it is committed to production. Because of our excellent irradiation facilities in our research reactors, consisting of many fuel and material testing loops, see Table V, we have a large volume of Zircaloy and UO_2 technology and experience equal and in excess of some of the giants in the power reactor field. This is evident by the large number of technical agreements we have with such countries as the U. S. A., U. K., France, Italy, Russia and Japan.

Table V NRX and NRU Loops

	Coolant	kW	°C	I. D. (cm)
NRX: X-1	Pressurized Water	200	316	2.36
X-2	Pressurized Water	100	316	2.36
X-3	Pressurized Water	200	316	2.36
X-4	Boiling, Fog, Superheated Steam	200	449	2.36
X-5	Pressurized Water	550	343	6.35
X-6	Pressurized Water - Boiling	250	316	3.76
X-7	Organic	200	750	3.81
X-8	Water	0	100	4.57
NRU: U-1	Boiling, Fog, Superheated Steam	8000	538	10.16
U-2	Pressurized Water - Boiling	4000	343	10.16
U-3	Organic	2500	427	8.26
U-5	Pressurized Water	0	354	-

7.6 Fuel Bundle Performance

Our program has now many years of experience of successful fuel irradiation, e. g., 40,000 fuel bundles in NPD, Douglas Point, Pickering, Gentilly and KANUPP, as shown in Figure 29, have achieved design burnups and ratings. The increase in bundle power that has occurred over the years is illustrated in Figure 30 which shows the increase from 220 kW ($\int \lambda d\theta$ 2.9 kW/m) for NPD to 735 kW (4.8 kW/m) for Bruce. An example of a Douglas Point bundle after reaching 432 MWh/kgU (18,000 MWd/TeU) is shown in Figure 31. However, some fuel bundles have become defective during operation and had to be discharged prior to their terminal burnup. The percentage of fuel that has been affected has been small, as shown in Table VI (January 1973). The cause of these defects has been traced to a bundle whose power is substantially increased after a prolonged period of low power. An example of which is shown in Figure 32. As our reactors have on-power fuelling and per channel monitoring, the defects have all been discharged on a routine basis.

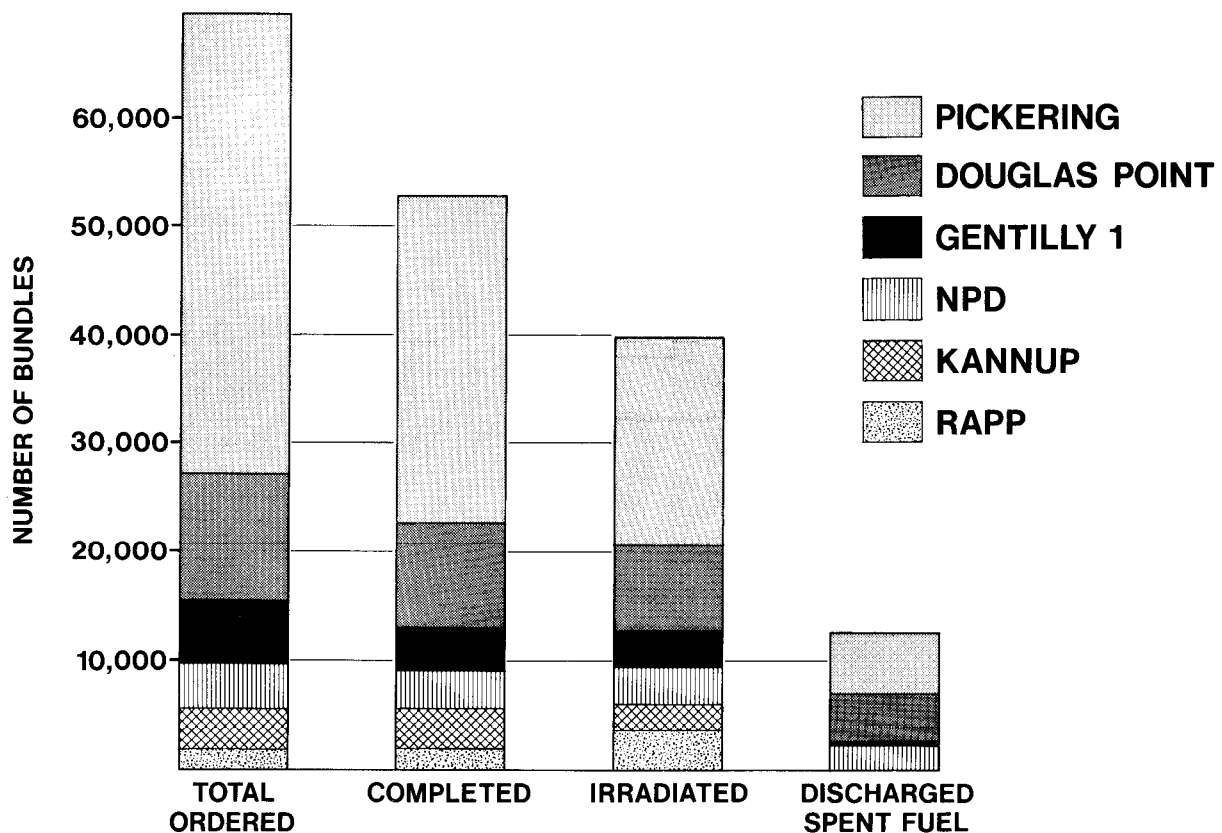

Figure 29 CANDU Fuel Production and Irradiation
(to January 1973)

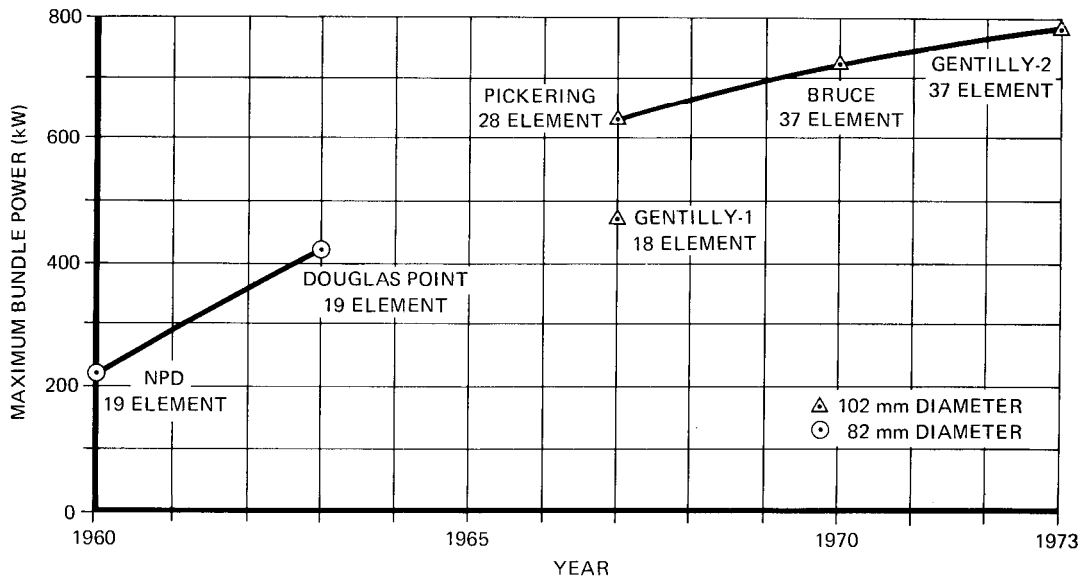

Figure 30 Bundle Power Vs Year of Design

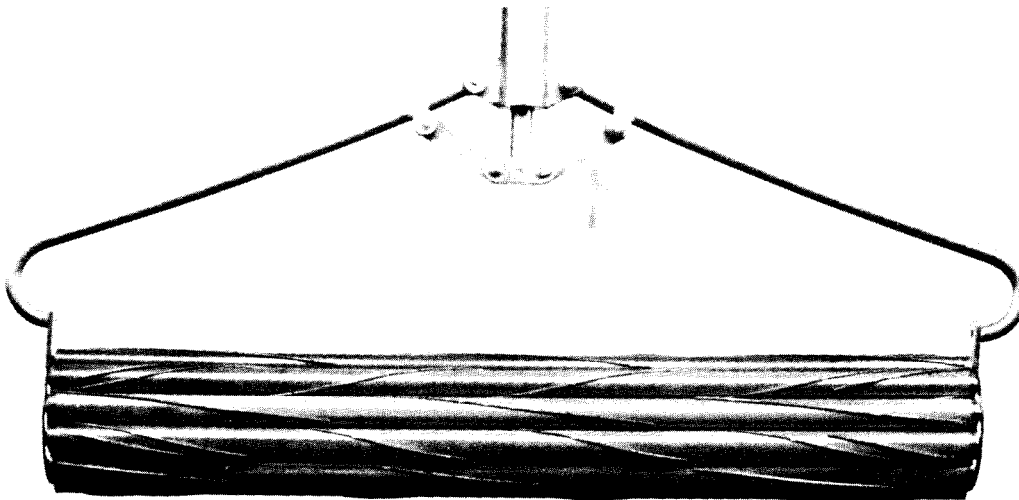

Figure 31 This Douglas Point Fuel Bundle, 495 mm long, had raised more steam than 25 carloads of Coal when the picture was taken

Table VI Fuel Performance
(To January 1973)

Generating Station	Bundles Irradiated	No. of Defects	Defect Percentage
NPD	3328	11	.33
Douglas Point	7827	66	.84
Pickering			
Unit 1	8072	76	.94
Unit 2	6892	NIL	NIL
Unit 3	4680	NIL	NIL
Gentilly	3214	14	.44
KANUPP	2288	NIL	NIL
RAPP	<u>3672</u>	<u>NIL</u>	<u>NIL</u>
Total	39973	167	.42

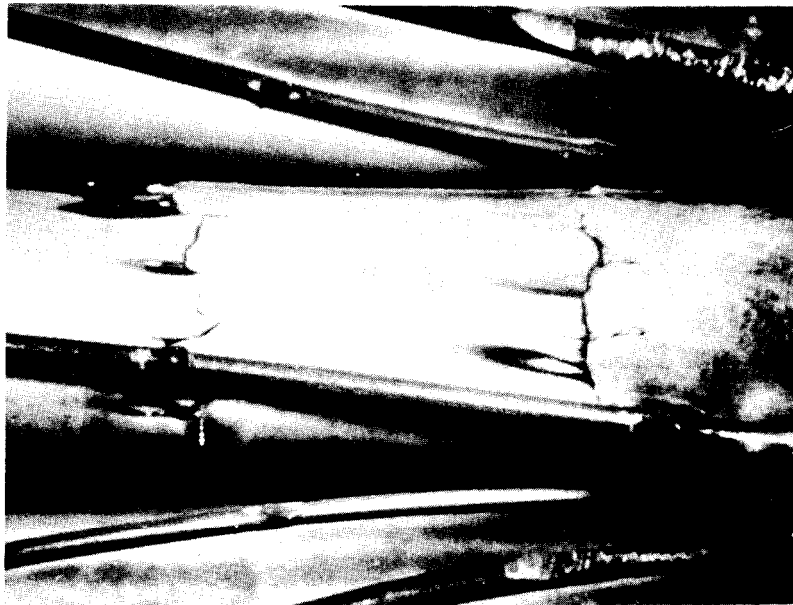

Figure 32 Douglas Point Defect Example

Power changes can occur from the following conditions; the insertion or withdrawal of reactivity mechanisms such as booster rods or absorbers (see Section 8.2), or changes due to moving fuel along the channel, or when the reactor is operated at less than 100% power for a significant time, i. e. , greater than one day, and then returned to full power.

The defect criteria that we have established from experience in irradiations in the NRU loops at Chalk River, NPD, Douglas Point and Pickering is shown in Figure 33. It is a plot of outer element rating versus burnup and indicates a decrease in element rating that an element can withstand when the element rating is increased up to the finite probability line.

The solution to the problem of this type of defect has been to modify our fuel management and reactor operations to minimize power changes and develop a more tolerant fuel, capable of withstanding significant power changes during its life. This type of fuel is called CANLUB⁽⁹⁾ in which a thin graphite layer is superimposed between UO₂ pellets and Zircaloy sheathing. With these changes and our increasing operating experience, we believe that our target defect rate of less than 0.3% for a mature station will be obtainable in the future. An up-to-date (May 73) paper on our fuel performance is given in Ref. 10.

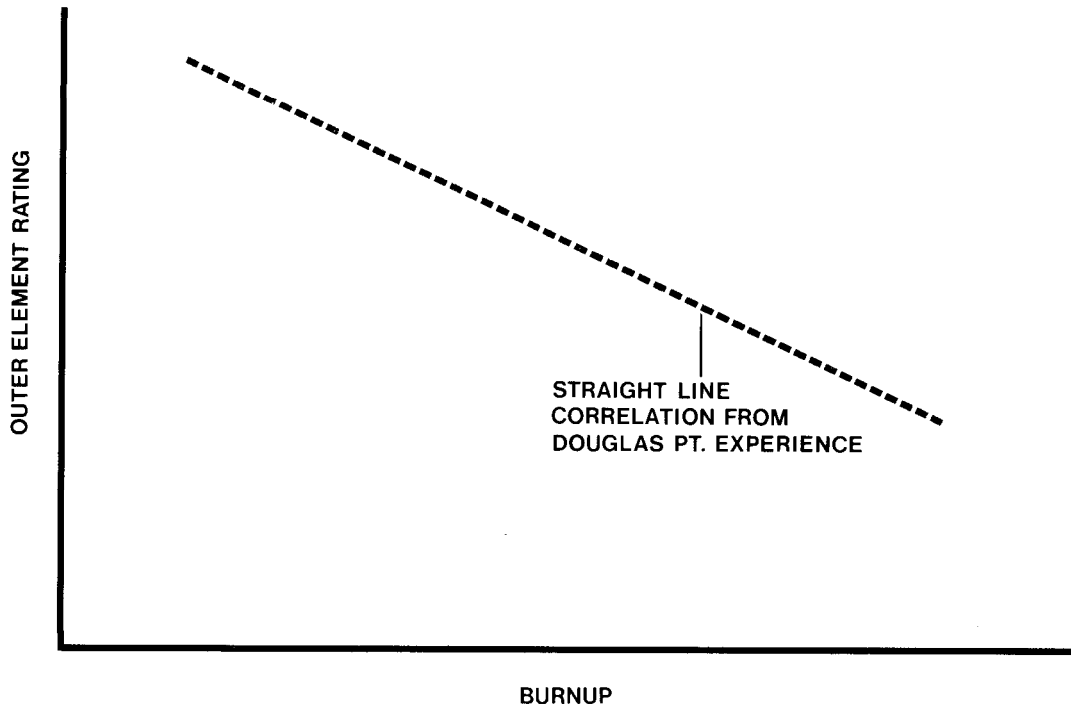

Figure 33 Douglas Point Defect Criteria

7.7 Bundle and Element Behaviour Under Extreme Conditions

Zircaloy clad UO_2 fuel can survive extreme conditions for limited periods of time such as gross overpower, dryout and pressure and temperature cycles.

7.7.1 Gross Overpower

Gross overpower can result in a small volume of UO_2 achieving central melting, i. e., 2800°C or $\int \lambda d\theta$ of ~ 7.2 kW/m, which causes the UO_2 to volumetrically expand 10% greater than normal, resulting in a significant increase in sheath strain which can cause rupture. An example of this is shown in Figure 34, which is a cross-section of an experimental element taken to this condition.

7.7.2 Dryout

Canada has pioneered in reactor heat transfer testing with experimental and power reactor fuels and therefore has gained a large amount of operating experience with fuel in two-phase flow at critical heat flux (CHF) condition or dryout.

All reactor fuel channel conditions are specified so that a significant margin of safety is available to prevent dryout occurring during normal operation.

As noted, dryout will significantly increase the sheath temperature depending on the coolant conditions and surface heat flux. See Figure 35. However, Zircaloy clad UO_2 fuel elements can operate at these elevated temperatures for limited periods of time, inversely proportional to temperature. See Figure 36. The dotted lines refer to elements which defected due to extremely high temperature $\sim 900^\circ\text{C}$ when they bowed towards the pressure tube and caused poor heat transfer due to local coolant starvation. Other alloys such as $\text{Zr-2}\frac{1}{2}\text{Nb}$ and Zr-Cr-Fe are being developed for continuous operation in this condition. If Zircaloy is operated too long at these high temperatures it will oxidize and a sheath failure will occur, as shown in Figure 37.

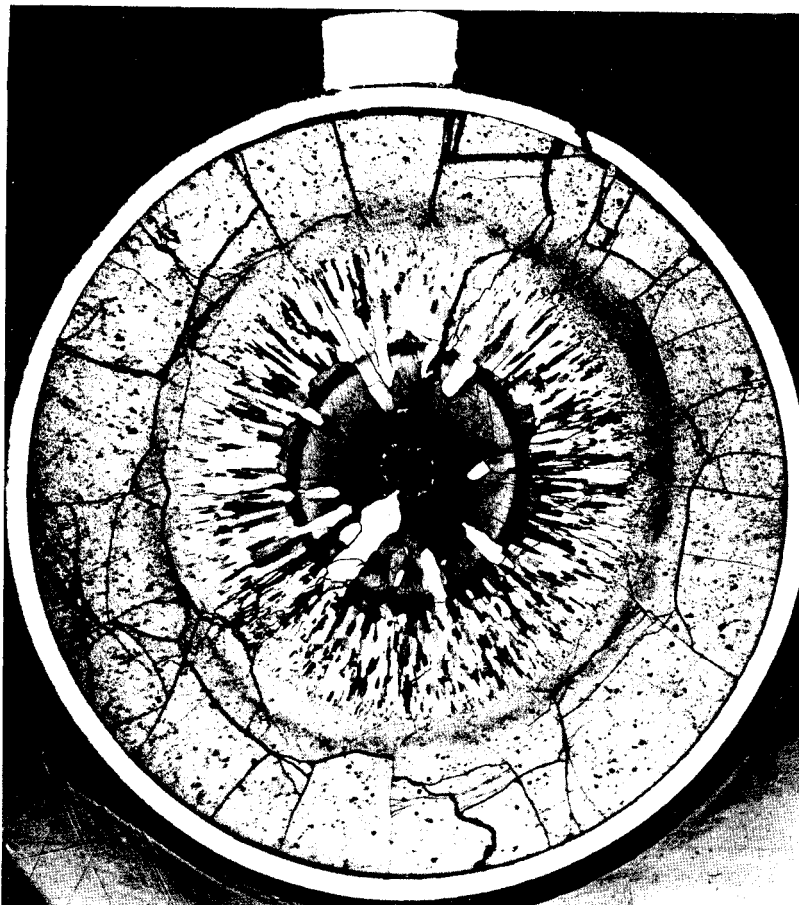

Figure 34 Cross Section of Element and Centre Melting in UO_2 Showing Defect in Fuel Element Sheath

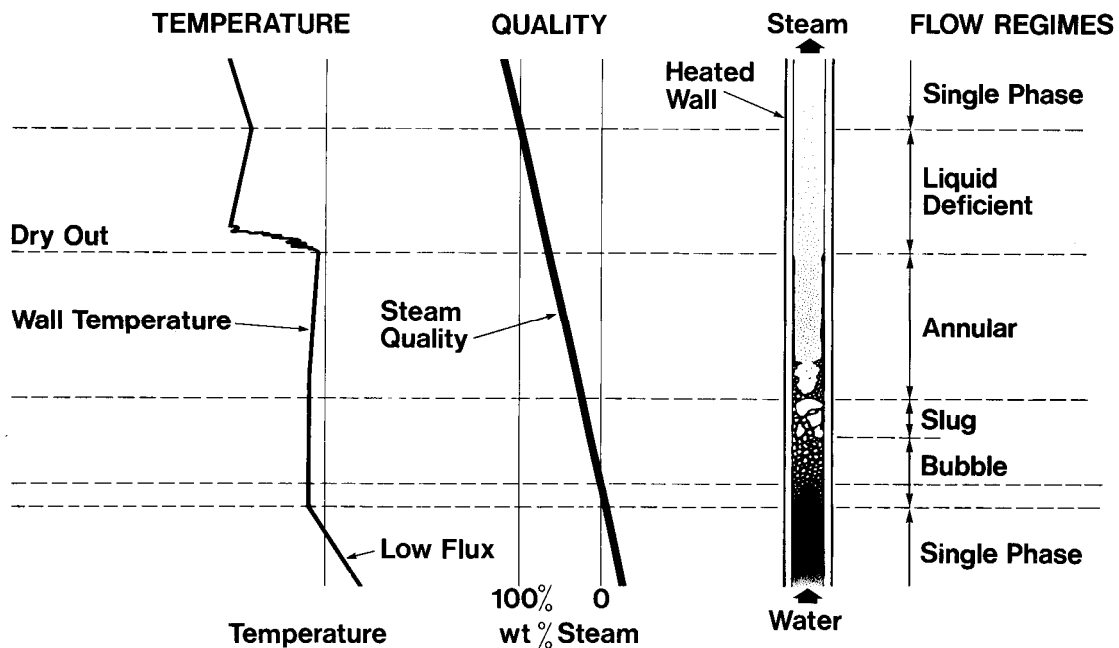

Figure 35 Thermal and Hydraulic Regimes in Vertical Upward Flow

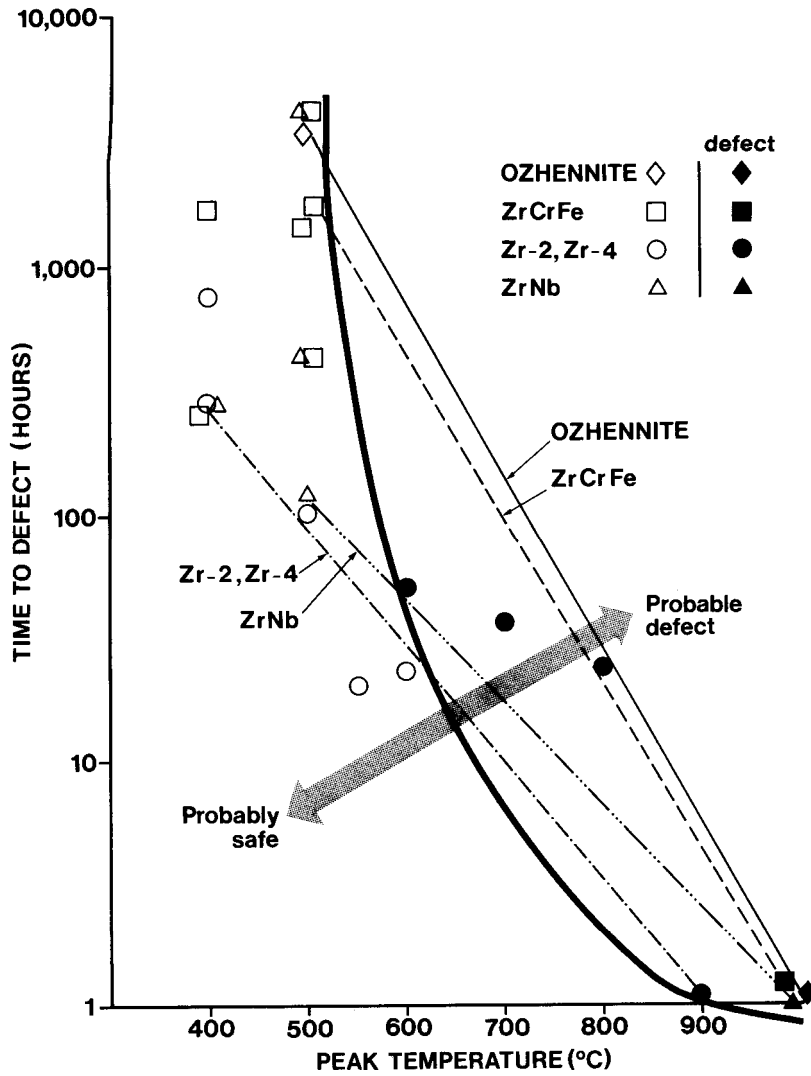

Figure 36 High Sheath Temperature Operation Vs Time for Various Zirconium Alloy Fuel Elements

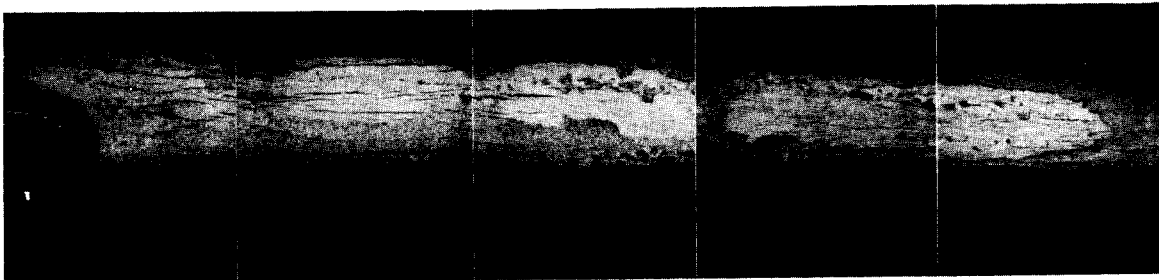

Figure 37 High Temperature Corrosion Failure of a Fuel Element

7.7.3 Pressure and Temperature Cycles

Due to changes in primary circuit pressure and temperatures, the fuel sheathing will experience various pressure and temperature cycles during its life. To date we are unaware that this adversely affects the fuel sheath's performance life, as fuel in both NPD, Douglas Point and CRNL irradiations have experienced many hundreds of cycles without deterioration.

8. FUEL PHYSICS AND MANAGEMENT

After the fuel has been in the core for some time, the buildup of fission product poisons and the depletion of fissionable uranium cause the excess of neutrons produced by the fuel (the "reactivity") to decrease. This process is called "burnup" and is usually expressed in terms of the total energy produced by the fuel per unit mass of initial uranium; that is, in "megawatt hours per kilogram", or "megawatt days per tonne". The rate at which new fuel is added to the core is adjusted, so that the reactivity decrease due to burnup is balanced by the reactivity increase of the fresh fuel, in order to maintain the reactor critical. The refuelling rate determines the average residence time (or "dwell time") of the fuel in the core and hence the average burnup on discharge.

Anything in the core which absorbs neutrons will reduce core reactivity, requiring a higher fuelling rate to maintain criticality and consequently reducing burnup. The reactor core is designed to use neutrons as efficiently as possible in order to obtain maximum burnup. Core parameters, such as radius, length, lattice pitch, reflector thickness, fuel and channel geometry, etc., are optimized for minimum total unit energy costs. Structural materials, i. e., pressure tubes and calandria tubes, are selected for low neutron absorption - zirconium alloys are used most frequently because zirconium has a low neutron absorption cross-section. Fuel bundles are designed to have as little structural material as possible. In CANDU reactors refuelling is done continuously on-power; no removable absorbers are required to compensate for burnup between refuellings as in other systems. Reactivity mechanisms are the minimum necessary for system control. This improves the burnup as well as producing high availability.

The in-core fuel management scheme refers to the manner in which new fuel is added to the core replacing burned up fuel. In CANDU PHW reactors, fuel is added on-power by inserting a fixed number of new bundles in one end of a channel and removing the same number of spent bundles from the other end. For example, if 8 bundles are added to a 12-bundle channel, the last 8 bundles in the channel are discharged, and the first 4 bundles are pushed along to the last four positions. (This is called an "8 bundle shift".) This gives a higher burnup than replacing all 12 bundles at once because those bundles which were operating at lower power during the first cycle, and consequently have lower burnup, are left in for a second cycle.

Fuel in adjacent channels is pushed through in opposite directions ("bidirectional refuelling"). Thus fresh fuel in one end of a channel is directly adjacent to burned up fuel in the nearest neighbouring channels. This tends to make the average fuel properties uniform along the channel, producing a symmetric axial power distribution which closely resembles a cosine. (See Figure 38.)

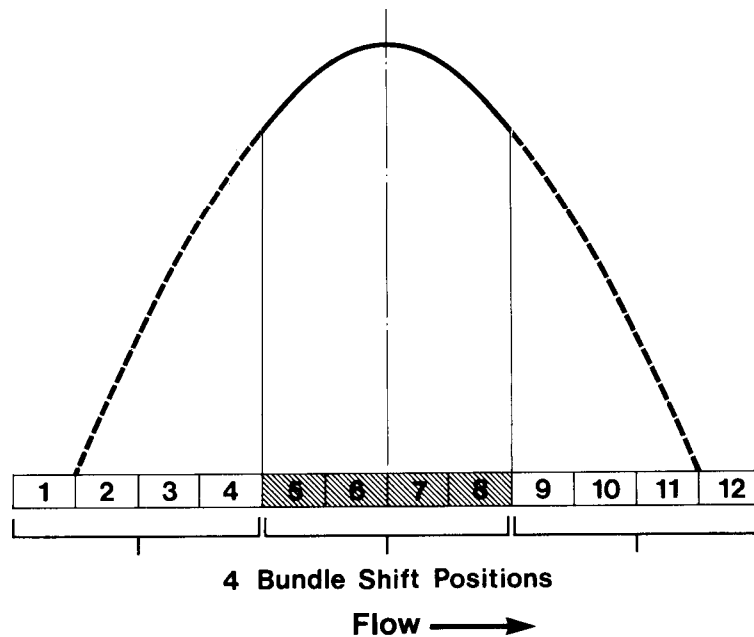

Figure 38 Douglas Point Axial Flux Profile

The axial neutron flux distribution for NPD, Douglas Point and Bruce reactors are approximately a cosine, but Pickering axial flux shape is distinctly different because it uses absorber rods as a reactivity mechanism, which tend to flatten flux, see Figure 39. This figure also illustrates the movement of bundles along the channel during an eight bundle shift.

The radial flux distribution for a bare reactor is a Bessel function but can be modified or flattened to obtain a higher power density from the reactor by a reflector on the outside of the core and/or differential fuelling of the core, i. e., the refuelling rate in the inner region is adjusted so that the burnup is higher there, and the reactivity lower. This tends to reduce power in the inner region, flattening the power distribution. This produces a higher total power generation from the same size core.

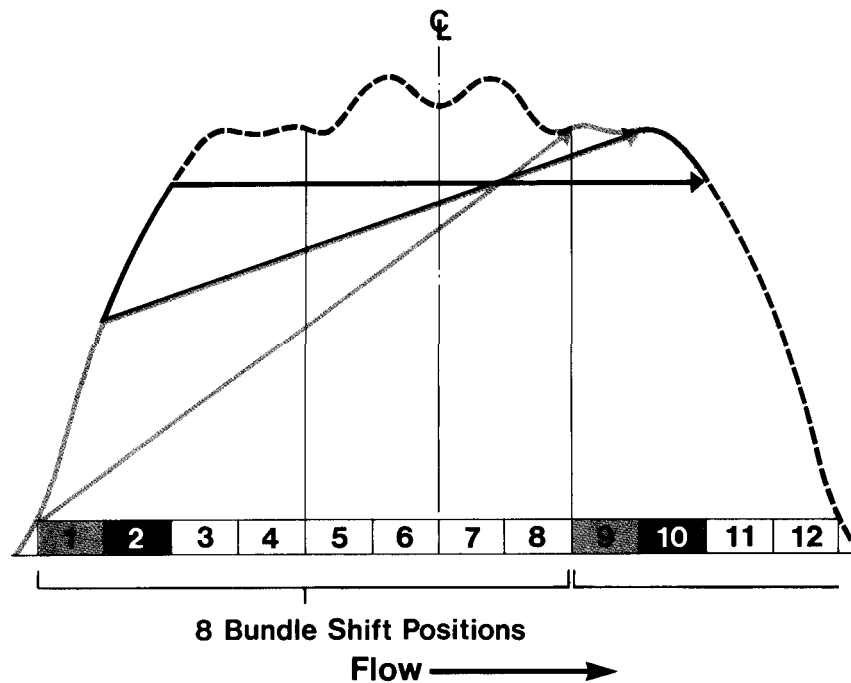

Figure 39 Pickering Axial Flux Profile

8.1 Fuel Bundle and Core Flux Distributions

In Figure 40 the neutron flux distribution radially through a fuel bundle is shown. It is noted that the neutron flux is depressed as it traverses the various components making up the fuel channel, i.e., calandria tube, gas space, pressure tube, reactor coolant and fuel elements. As the CANDU system uses short bundles, there is axial peaking in the neutron flux at the junction of each bundle, which is also shown on the same figure.

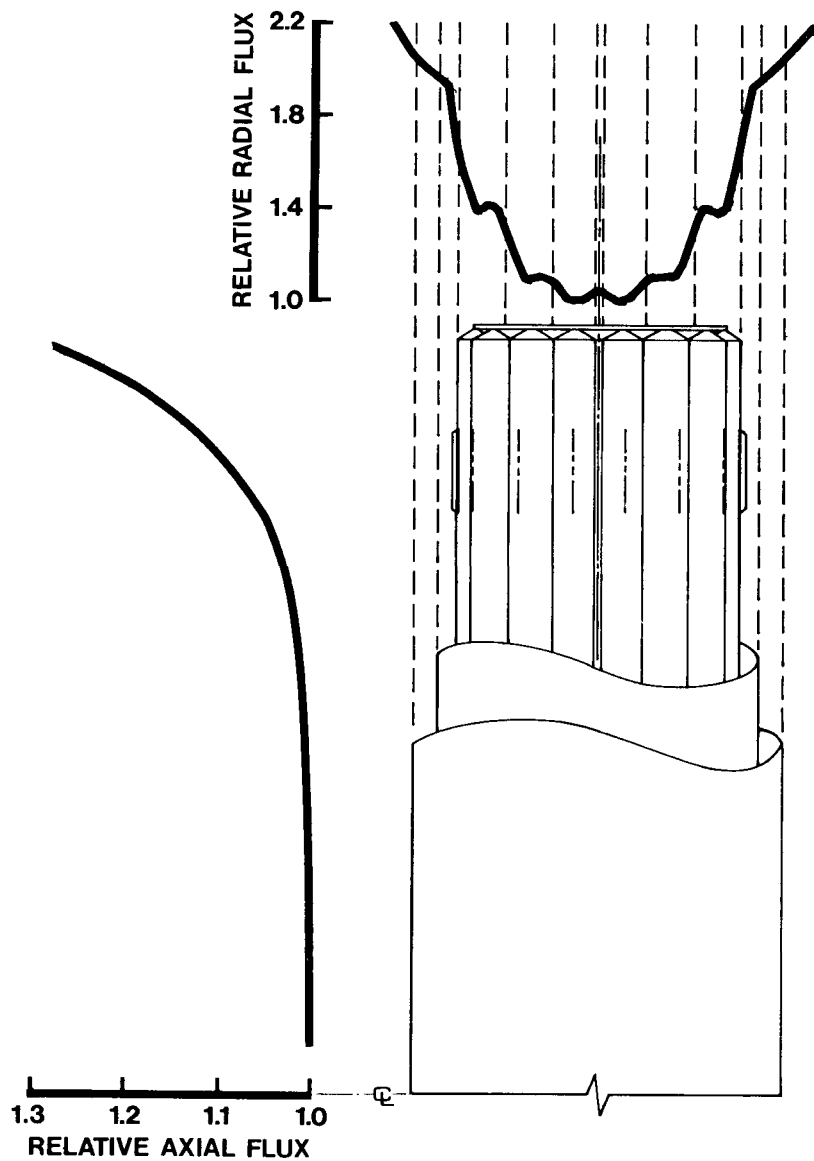

Figure 40 Bundle Radial and Axial Flux Distribution

8.2 Reactivity Mechanisms and Booster Rods

To provide the necessary extra reactivity to override the xenon poison growth after a trip from full power, booster rods or absorbers are required. Booster rods are enriched fuel rods stored outside of the core until required, whilst absorber rods are stored in the core and are withdrawn to provide the extra reactivity. In Pickering the absorber rods use cobalt for neutron absorption. The irradiated cobalt can be sold as a useful bi-product for medical therapy. The booster rods used in NPD and Douglas Point are modified flat plate type fuel elements cooled by the low pressure moderator. Gentilly required more powerful booster rods due to the large light water load. A rod was developed using the techniques developed for the enriched U-Al fuel for NRX and NRU. It consists of a fuel bundle made up of 61 elements using U-Al clad in Al as shown in cross-section in Figure 41. A more powerful booster rod has been developed for the Bruce reactor and consists of 18 annular elements formed by co-extruding U-Zr with Zr and assembling the six bundles as shown in Figure 42. Future booster rods may use Pu instead of U-235 as the enriched material and will be in the form of graphite coated particles of PuO_2 dispersed in graphite pellets and sheathed in Zircaloy. This type of booster rod is being built today for testing in Gentilly.

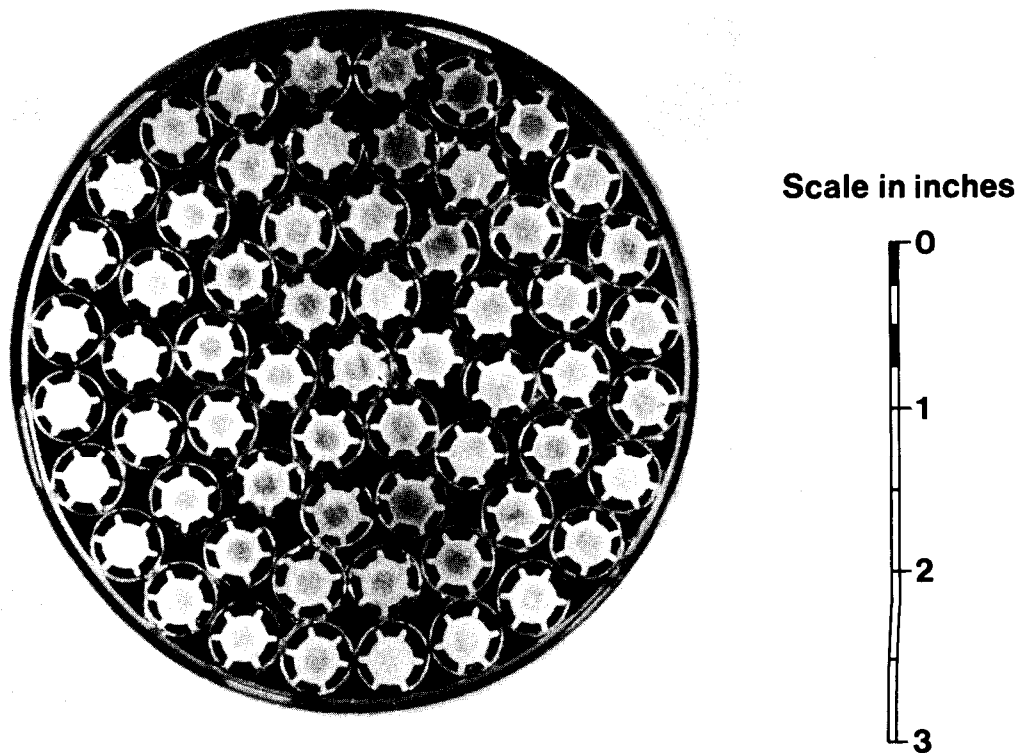

Figure 41 Gentilly Booster Cross-Section

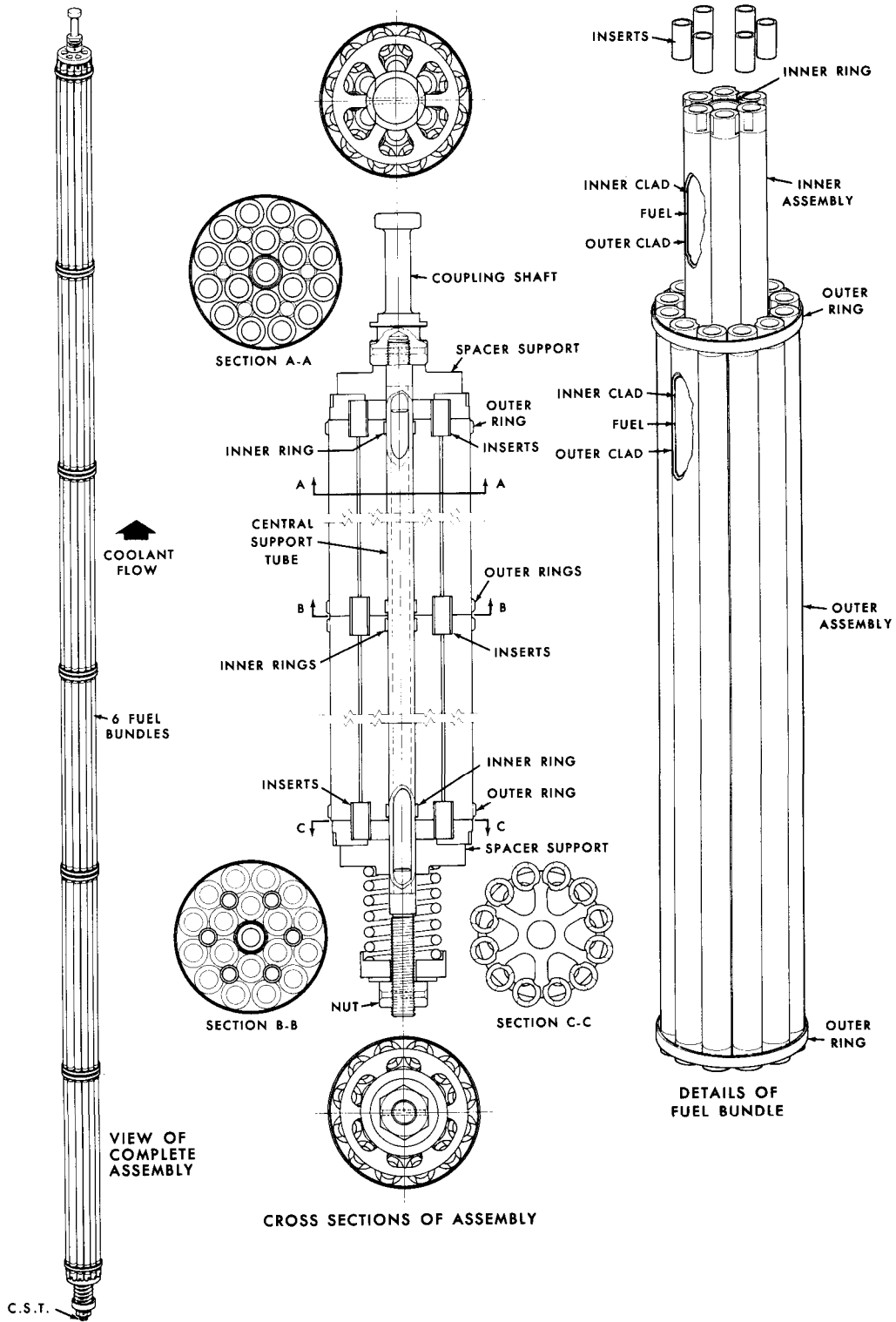

Figure 42 Bruce Booster Fuel String Assembly

9. FUEL PROCUREMENT

AECL, as your nuclear consultant, would be responsible for the design, technical specification and the development program associated with the first core fuel, also the preparation of the tenders and their technical evaluation prior to ordering the first core. See Figure 43.

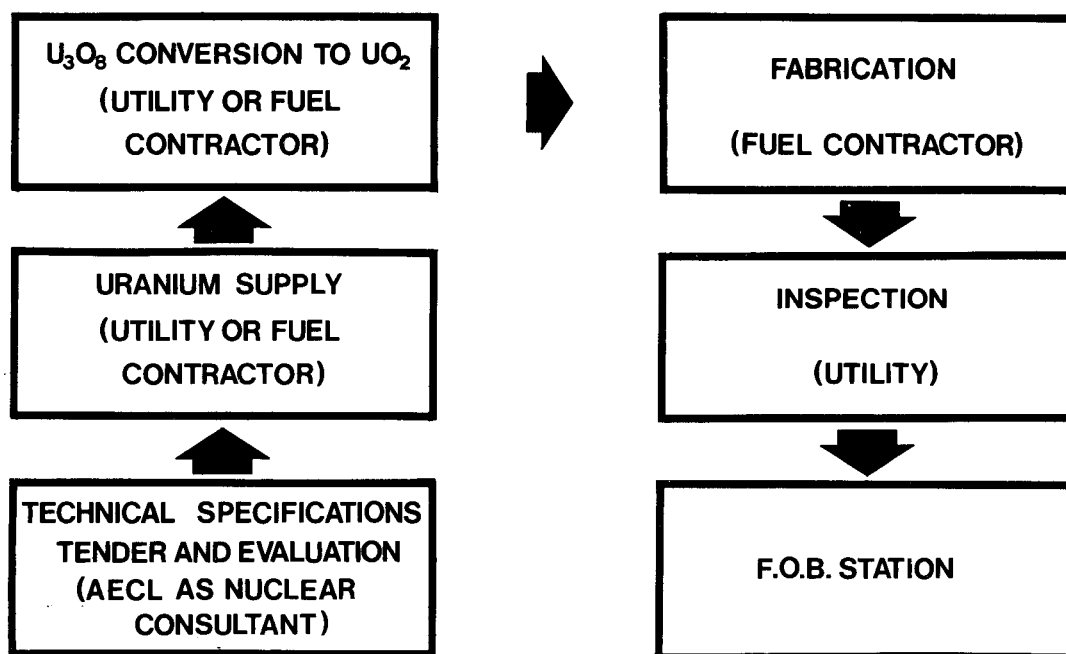

Figure 43 Fuel Supply Organization

For the first charges of NPD and Douglas Point, AECL supplied the uranium to the fuel contractor. For later reactors such as Pickering and Bruce, Ontario Hydro bought the uranium in bulk and is also responsible for the conversion of U₃O₈ (yellowcake) to UO₂ powder. Eldorado is the only company that can do this in Canada at present. For small orders for Gentilly and NPD, we have contracted with the fuel fabricators to supply both uranium and the fuel fabrication.

We do not ask for fuel warranty but demand a very high quality control program. This QC program is continually audited by the utilities inspectors and any concessions must be approved by the design engineer. To date we have not discovered any manufacturing defects in the many thousands of bundles we have irradiated. This is a great credit to our fuel contractors and inspectors.

10. FUEL INDUSTRY

The UO_2 fuel requirements already committed for the various reactors built and under construction are shown in Figure 44 starting with the first charge for NPD, Douglas Point, RAPP, Pickering, Bruce and Gentilly, and replacement charges. To indicate the growing demand of production in the future, Figure 45 shows the cumulative supply required to 1990. This would have to be increased by any further commitments by other utilities or export orders. This increased demand over the years is reflected in the fabricator's production rate per year, which must be maintained to meet it.

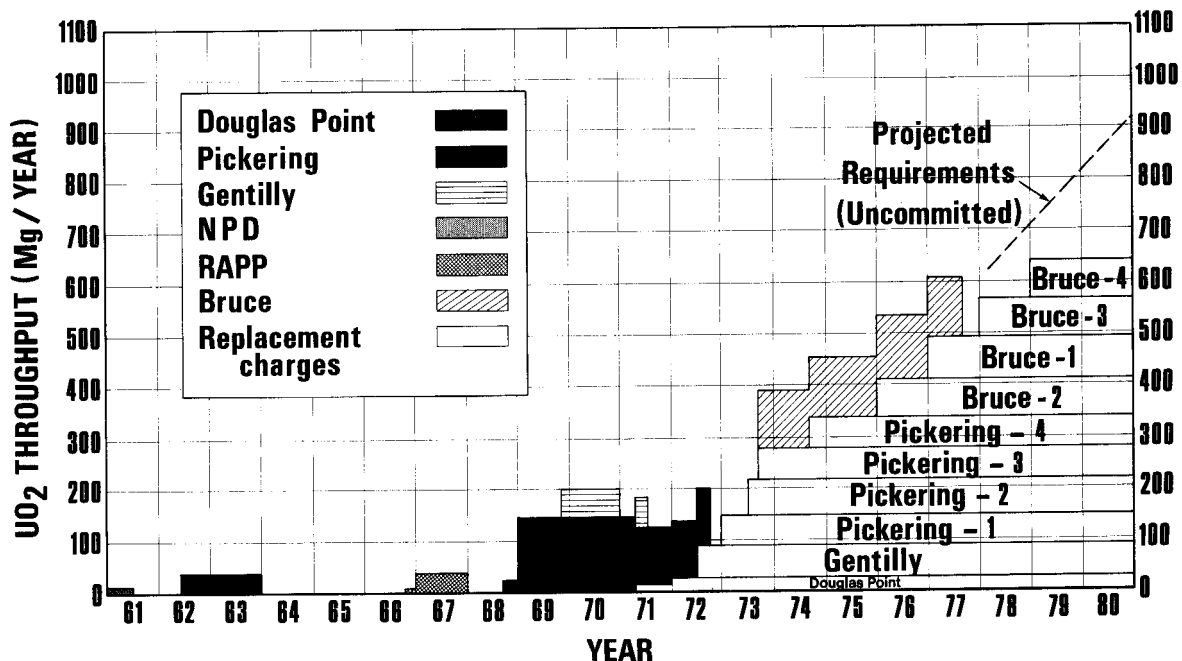

Figure 44 Committed UO_2 Requirements for Canadian Power Reactors

Figure 46 shows the production per year, indicating that both companies have to be up to approximately 400 Mg a year by 1980.

CGE is slightly ahead of Westinghouse in capacity right now, as they have had experience with the large first charge Pickering order, although both have replacement orders for 1973. When Bruce first charge and future Pickering replacement orders are placed, both companies will be expanding very rapidly and have already started to do so. By 1990 the annual production capacity of both companies will have to be approaching 1000 Mg a year to allow for the requirements of other utilities.

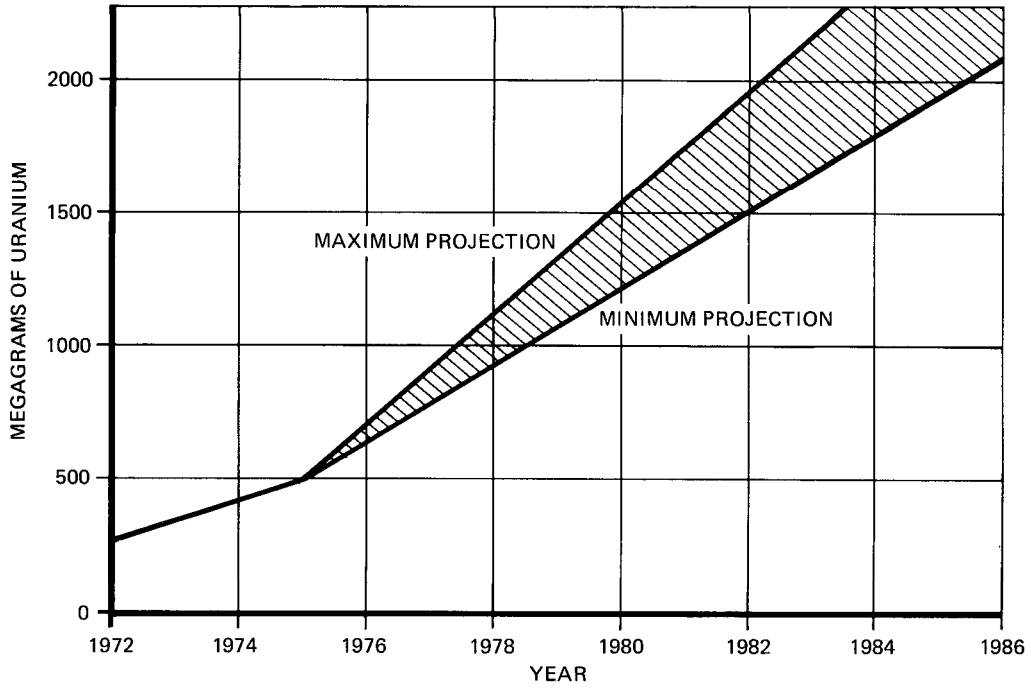

Figure 45 Cumulative Fuel Demand

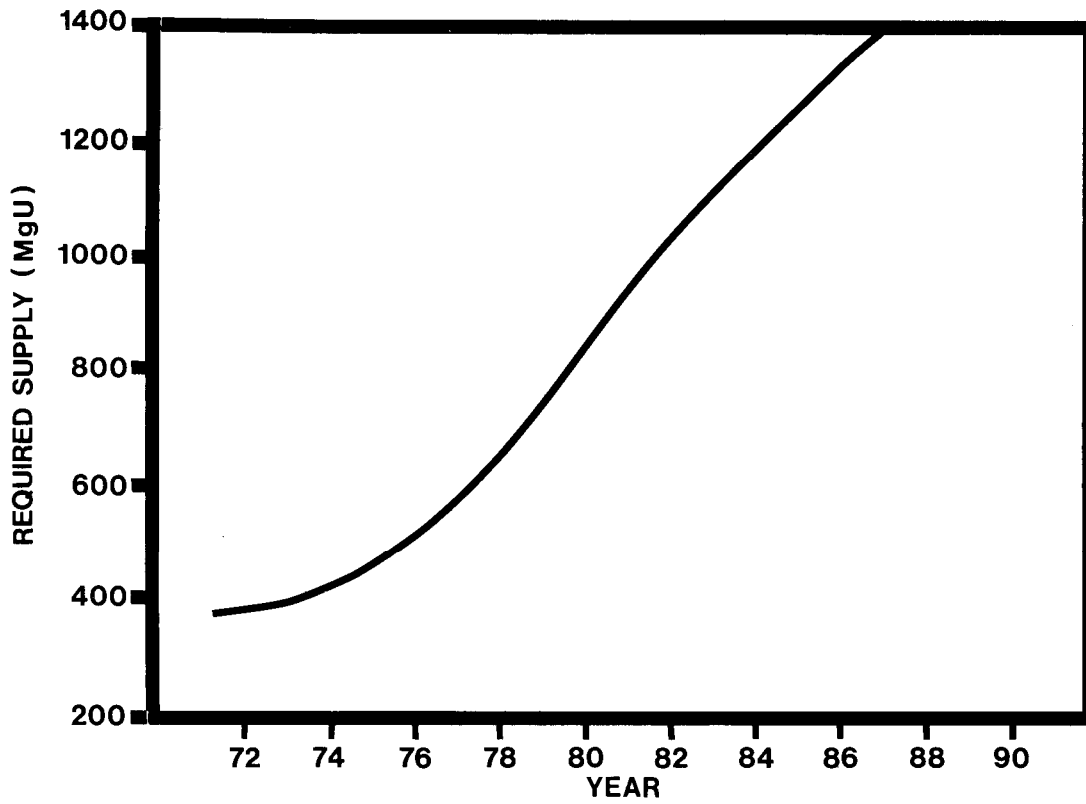

Figure 46 Fuel Production Rate Per Year

11. FUEL COSTS

Figure 47 shows the dramatic effect we have been able to produce on reducing the total fuel costs over the years. This is a plot of the various fuel charges that have been competitively tendered over the years and plotted against the year in dollars for the year of the contract. So you can see from NPD to Douglas Point to Pickering we have had a major drop in fuel costs. Since then we have essentially maintained constant fuel costs and thus countered the effect of escalation by a decrease in fabrication costs.

11.1 Future Fuel Costs

Figure 48 predicts how the fuel prices may change. The factor we can predict most accurately is the fuel bundle fabrication costs, this will decrease with time. However, there will be a countering increase in uranium prices. It is very difficult to predict the uranium price with any certainty for the future years. A lot depends on what happens to the world price when the United States lifts the uranium embargo sometime in 1978 and starts importing uranium. The combined effect of these two factors are shown in Figure 49 and shows a relatively constant fuel price, if our uranium price is correct. However, even if it is not, our price is least sensitive to any increase in uranium price compared to other reactor systems, because we use natural uranium and do so with the highest of efficiency.

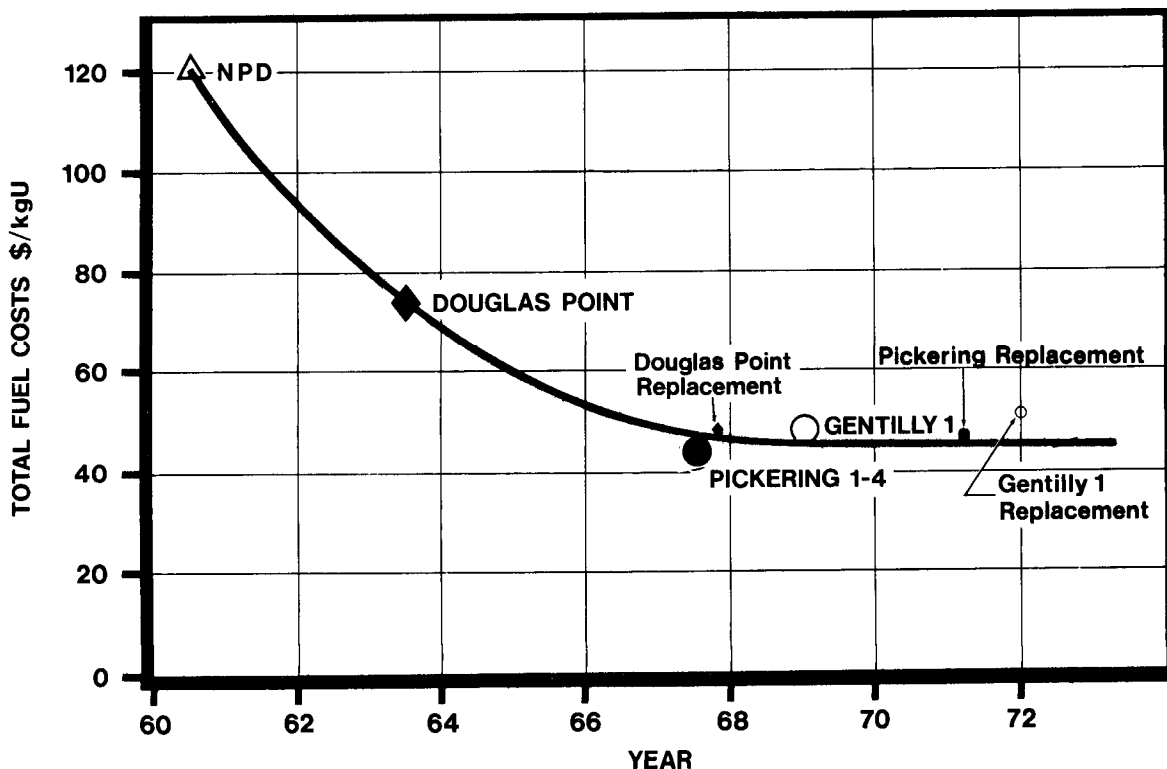

Figure 47 Canadian Total Fuel Costs

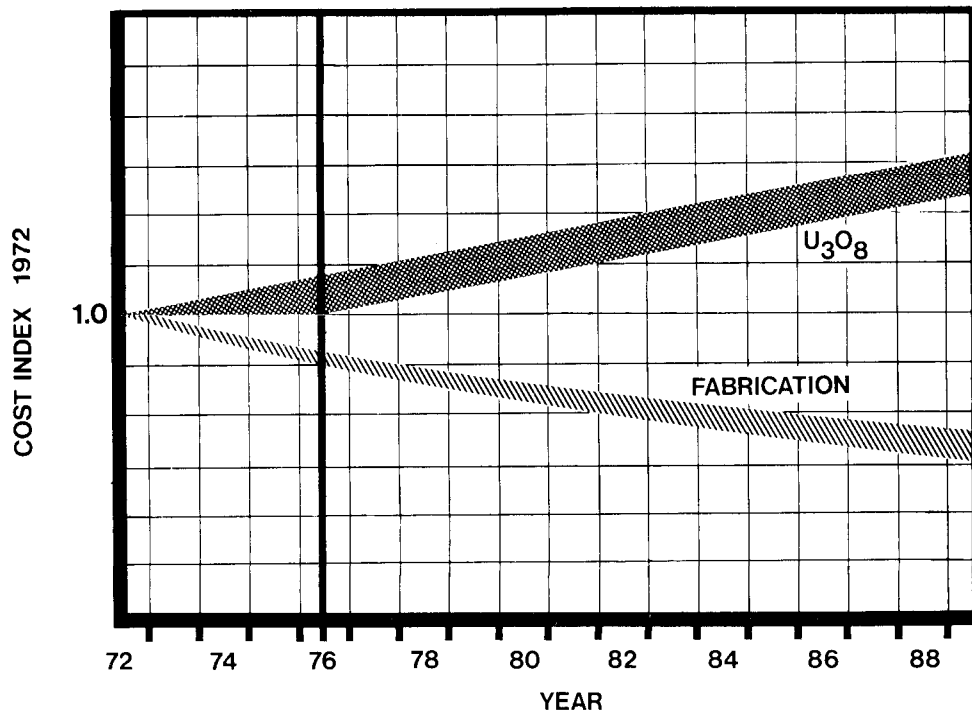

Figure 48 Predicted Costs for Fabrication and Yellowcake (U₃O₈)

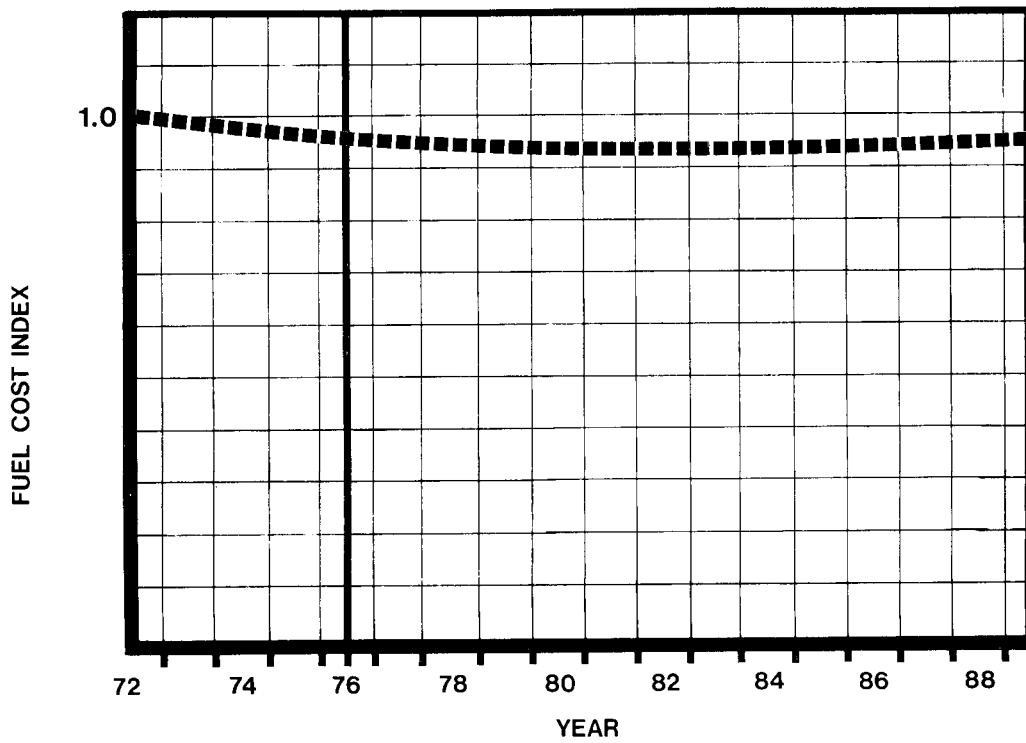

Figure 49 Predicted Fuel Cost Index 1976-89

SUMMARY

We have developed and produced in large numbers an efficient low cost fuel with good performance, and this has been produced by a competitive private fuel industry which has the capability of meeting the demands of the future.

ACKNOWLEDGEMENTS

The information contained in this paper has been obtained from many reports written by the AECL staff at CRNL and WNRE and are therefore too numerous to acknowledge individually.

REFERENCES

- (1) A. D. Lane et al: "The Thermal and Hydraulic Characteristics of Power Reactor Fuel Bundle Designs", Canadian Journal of Chemical Engineering, 41 5 (1963), 226.
- (2) R. D. Page et al: "Engineering and Performance of UO₂ Fuel Assemblies", Proc. Intern. Conf. Peaceful Uses Atomic Energy, Geneva, 10, 65, CRNL Report AECL-2018, Atomic Energy of Canada Limited (1964).
- (3) M. J. F. Notley and A. D. Lane: "Factors Affecting the Design of Rodded UO₂ Fuel Bundles for High Power Outputs", SM-99/35, IAEA Symposium on Heavy Water Power Reactors, Vienna 1967, AECL-2945.
- (4) R. D. Page: "Engineering and Performance of Canada's UO₂ Fuel Assemblies for Heavy Water Power Reactors", CRNL Report AECL-2949, SM-99/48, IAEA Symposium on Heavy Water Power Reactors, September 1967.
- (5) Z. Domaratzki: "Canadian Experience with Wire Wrapped Fuel for Power Reactors", CRNL Report AECL-3089, Atomic Energy of Canada Limited, May 1968.
- (6) R. G. Hart: "Technological Progress in Canadian Nuclear Fuels", CRNL Report AECL-2928, Nuclear Congress, Rome (1967).
- (7) L. R. Haywood et al: "Fuel for Canadian Power Reactors", Proc. Intern. Conf., Peaceful Uses of Atomic Energy, Geneva, A/CONF 49/A/156, CRNL Report AECL-3979, Atomic Energy of Canada Limited (1971).
- (8) J. R. MacEwan et al: "Irradiation Experience with Fuel for Power Reactors", Proc. Intern. Conf., Peaceful Uses of Atomic Energy, Geneva, A/CONF 49/A/158, CRNL Report AECL-3981, Atomic Energy of Canada Limited (1971).
- (9) J. A. L. Robertson: "Improved Performance for UO₂ Fuel", AECL-4366, Atomic Energy of Canada Limited, January 1973.
- (10) J. A. L. Robertson, R. D. Page and L. L. Bodie: "Canadian Fuel Performance", ANS, Chicago, Illinois, June 1973.
To be published.